

# SECTION X: CROSS SECTIONS

STATE OF SOUTH DAKOTA	PROJECT	SHEET	TOTAL SHEETS
	P-PH-PT 0025(81)158	X1	X99

Plotting Date: 12-04-2024

## INDEX OF SHEETS

- X1 General Layout with Index
- X2-X3 Soil Blocks
- X4-X99 Cross Sections



END P-PH-PT 0025(81)158  
 END GRADING AND INTERIM SURFACING  
 Station 529+20

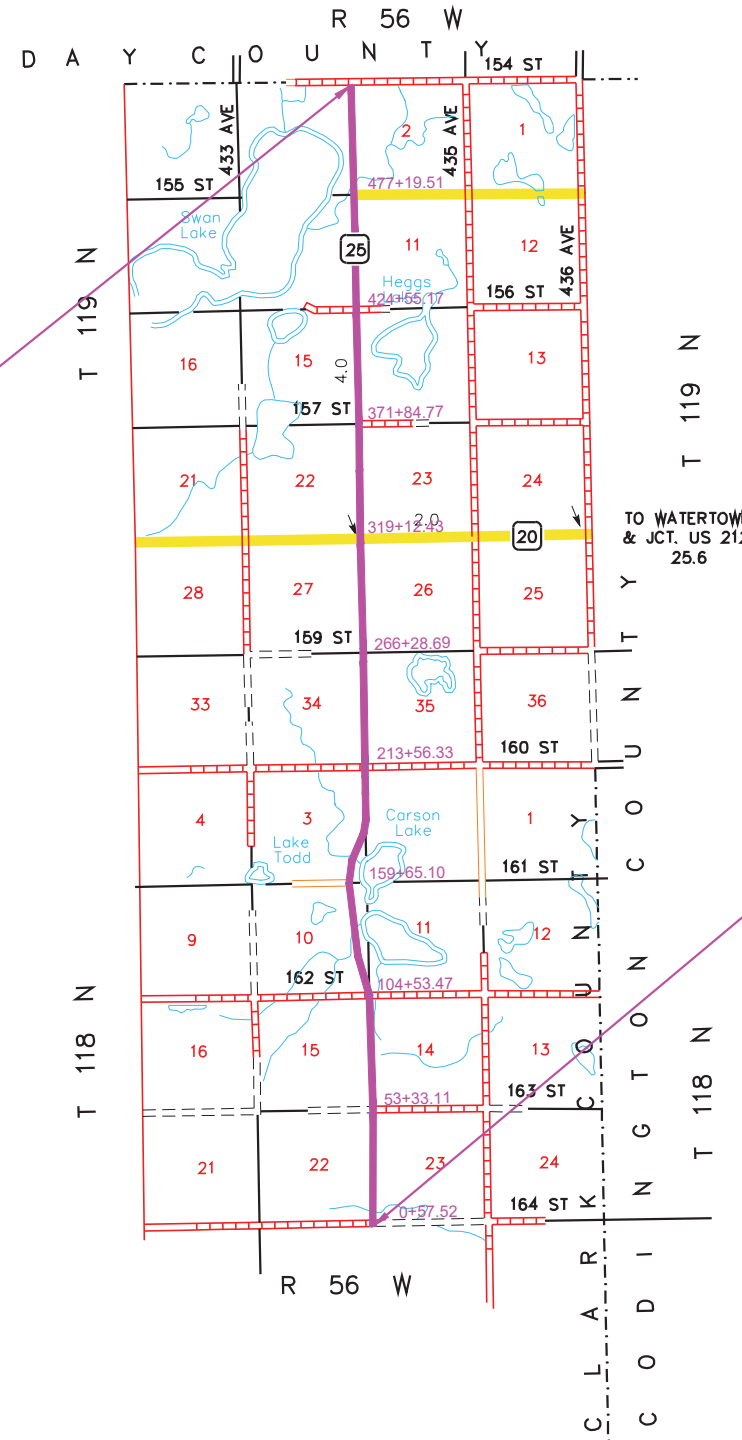

BEGIN P-PH-PT 0025(81)158  
 BEGIN GRADING AND INTERIM SURFACING  
 Station 0+50





Plotting Date: 12-04-2024

Hole Number	20
Station	429+00
Offset	120'LT
Depth, ft	0-12.0
Moisture Depth, ft	3.5
Moisture, %	22.0
Dry Loose Wt, lbs/cuft	75.2
% Passing 3/8	98.4
% Passing #4	98.3
% Passing #10	97.6
% Passing #40	93.4
% Passing #200	78.1
% Sand	19.5
% Silt	39.0
% Clay	39.0
Liquid Limit	42
Plastic Limit	20
Plasticity Index	22
Soil Color	Light Brown
Textural Class.	Silt Clay
AASHTO Class.	A-7-6 (13)

Hole Number	21	21
Station	443+00	443+00
Offset	100'RT	100'RT
Depth, ft	0-10.0	10.0-15.0
Moisture Depth, ft	4.0	11.5
Moisture, %	19.4	19.4
Dry Loose Wt, lbs/cuft	81.8	77.4
% Passing 3/8	94.7	99.2
% Passing #4	93.3	98.8
% Passing #10	91.2	98.7
% Passing #40	81.7	91.9
% Passing #200	62.7	73.1
% Sand	28.5	25.5
% Silt	29.0	29.7
% Clay	33.7	43.4
Liquid Limit	39	43
Plastic Limit	19	17
Plasticity Index	20	25
Soil Color	Brown	Light Brown
Textural Class.	Sandy Clay	Silt Clay
AASHTO Class.	A-6 (10)	A-7-6 (14)

Hole Number	22
Station	458+00
Offset	10.4'LT
Depth, ft	1.8-10.0
Moisture Depth, ft	4.5
Moisture, %	16.4
Dry Loose Wt, lbs/cuft	80.5
% Passing 3/8	96.0
% Passing #4	95.1
% Passing #10	94.1
% Passing #40	75.1
% Passing #200	53.0
% Sand	41.2
% Silt	25.7
% Clay	27.3
Liquid Limit	35
Plastic Limit	17
Plasticity Index	18
Soil Color	Light Brown
Textural Class.	Clay Sand
AASHTO Class.	A-6 (7)

Hole Number	23
Station	479+00
Offset	10.0'RT
Depth, ft	1.7-10.0
Moisture Depth, ft	4.0
Moisture, %	19.4
Dry Loose Wt, lbs/cuft	80.2
% Passing 3/8	97.9
% Passing #4	96.6
% Passing #10	94.5
% Passing #40	81.6
% Passing #200	70.3
% Sand	24.1
% Silt	42.9
% Clay	27.4
Liquid Limit	38
Plastic Limit	19
Plasticity Index	18
Soil Color	Light Brown
Textural Class.	Clay Silt
AASHTO Class.	A-6 (10)

Hole Number	24	24
Station	490+00	490+00
Offset	120'LT	120'LT
Depth, ft	0-9.0	9.0-15.0
Moisture Depth, ft	3.5	11.0
Moisture, %	28.0	22.0
Dry Loose Wt, lbs/cuft	69.7	72.1
% Passing 3/8	100.0	100.0
% Passing #4	100.0	100.0
% Passing #10	100.0	99.9
% Passing #40	99.4	99.4
% Passing #200	97.4	84.9
% Sand	2.6	15.0
% Silt	48.4	52.0
% Clay	49.0	33.0
Liquid Limit	47	33
Plastic Limit	23	18
Plasticity Index	24	15
Soil Color	Brown	Brown
Textural Class.	Silt Clay	Silt Clay
AASHTO Class.	A-7-6 (15)	A-6 (10)

Hole Number	25	25
Station	499+00	499+00
Offset	110'RT	110'RT
Depth, ft	0-10.0	10.0-18.0
Moisture Depth, ft	4.0	12.0
Moisture, %	21.7	19.1
Dry Loose Wt, lbs/cuft	75.3	76.7
% Passing 3/8	99.8	100.0
% Passing #4	99.5	99.6
% Passing #10	98.9	98.9
% Passing #40	94.5	93.3
% Passing #200	77.3	73.1
% Sand	21.6	25.8
% Silt	36.7	30.5
% Clay	40.6	42.5
Liquid Limit	41	41
Plastic Limit	19	17
Plasticity Index	23	24
Soil Color	Light Brown	Brown
Textural Class.	Silt Clay	Silt Clay
AASHTO Class.	A-7-6 (13)	A-7-6 (13)

Hole Number	26	26
Station	501+00	501+00
Offset	100'LT	100'LT
Depth, ft	0-9.5	9.5-15.0
Moisture Depth, ft	3.0	12.0
Moisture, %	13.1	19.3
Dry Loose Wt, lbs/cuft	74.8	73.7
% Passing 3/8	100.0	100.0
% Passing #4	99.7	99.4
% Passing #10	99.3	99.1
% Passing #40	94.5	94.3
% Passing #200	79.8	73.5
% Sand	19.6	25.5
% Silt	37.1	30.9
% Clay	42.7	42.6
Liquid Limit	42	42
Plastic Limit	19	18
Plasticity Index	23	24
Soil Color	Brown	Brown
Textural Class.	Silt Clay	Silt Clay
AASHTO Class.	A-7-6 (13)	A-7-6 (14)

Hole Number	27
Station	522+00
Offset	10.6'RT
Depth, ft	1.7-10.0
Moisture Depth, ft	5.0
Moisture, %	33.1
Dry Loose Wt, lbs/cuft	75.4
% Passing 3/8	98.4
% Passing #4	97.7
% Passing #10	96.7
% Passing #40	90.7
% Passing #200	83.9
% Sand	12.8
% Silt	46.2
% Clay	37.7
Liquid Limit	48
Plastic Limit	25
Plasticity Index	23
Soil Color	Brown
Textural Class.	Silt Clay
AASHTO Class.	A-7-6 (15)

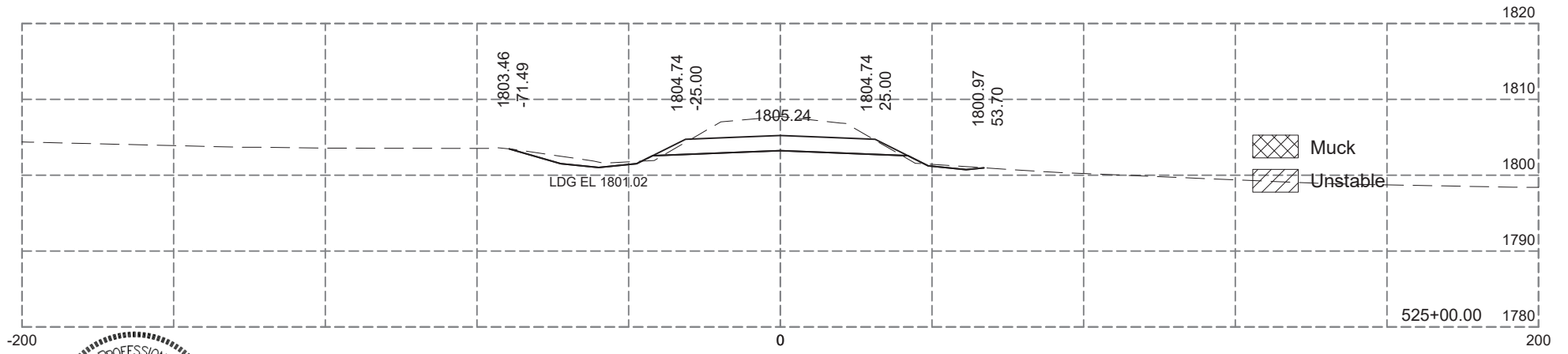
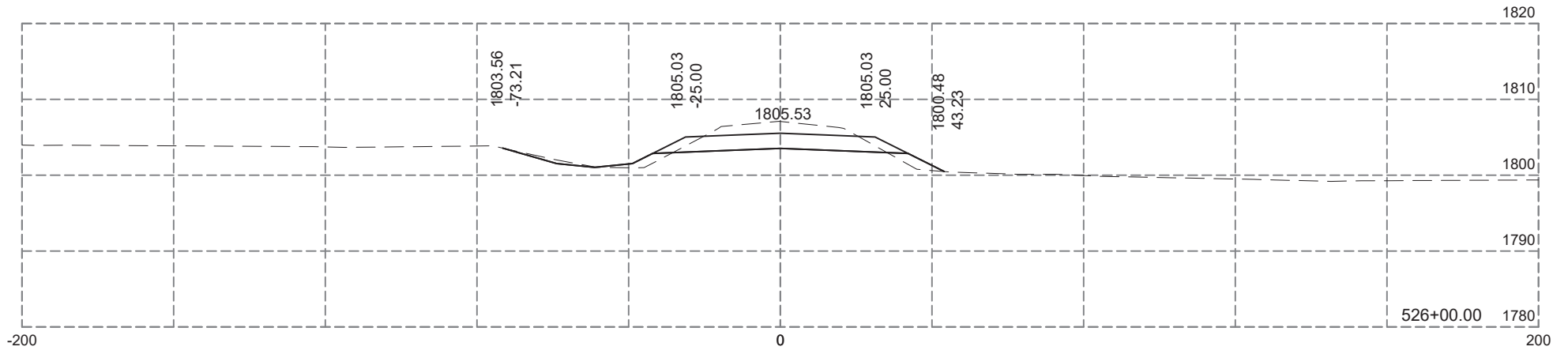
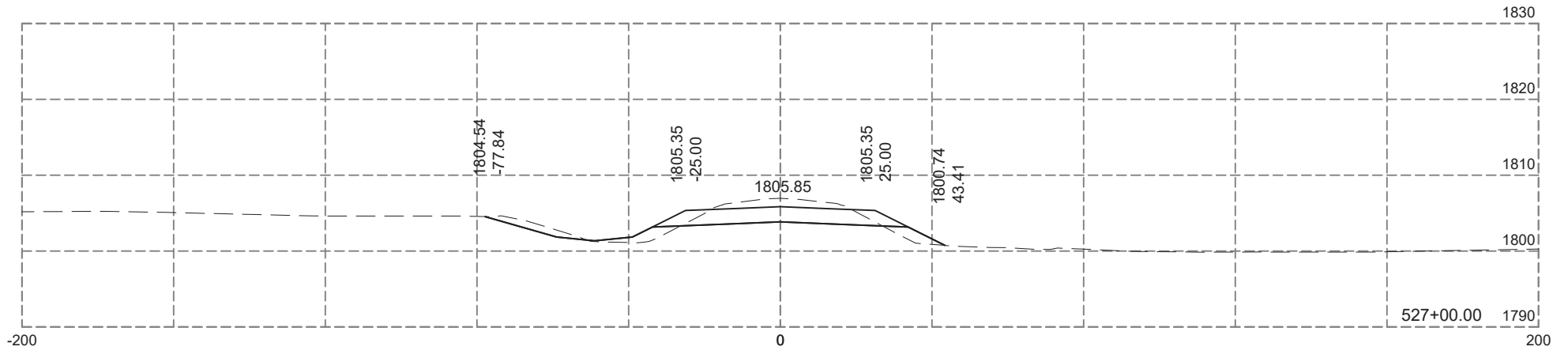
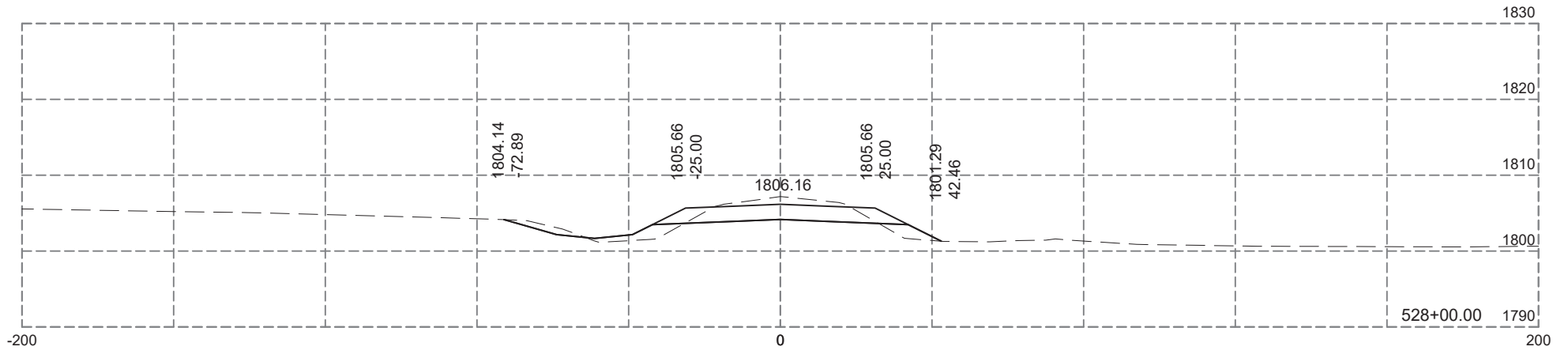
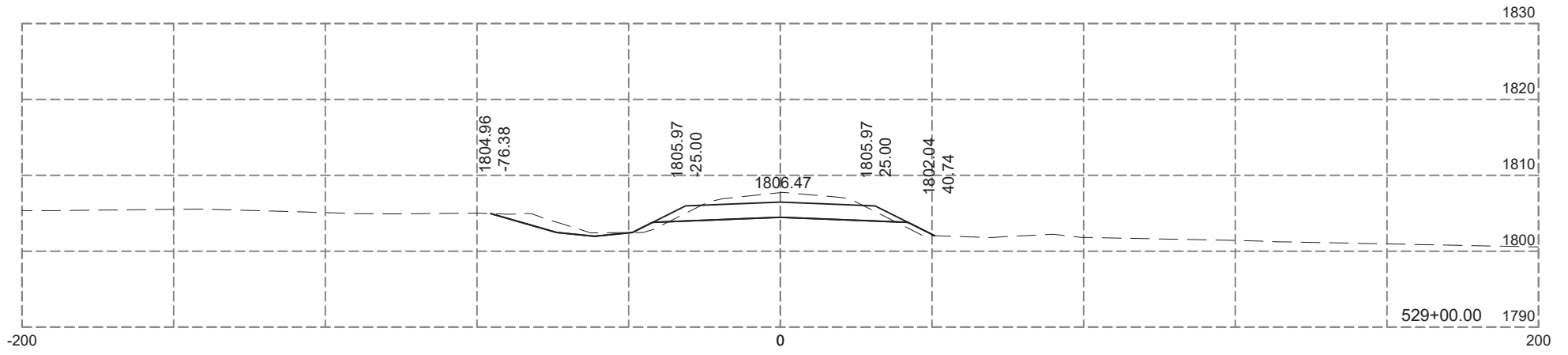
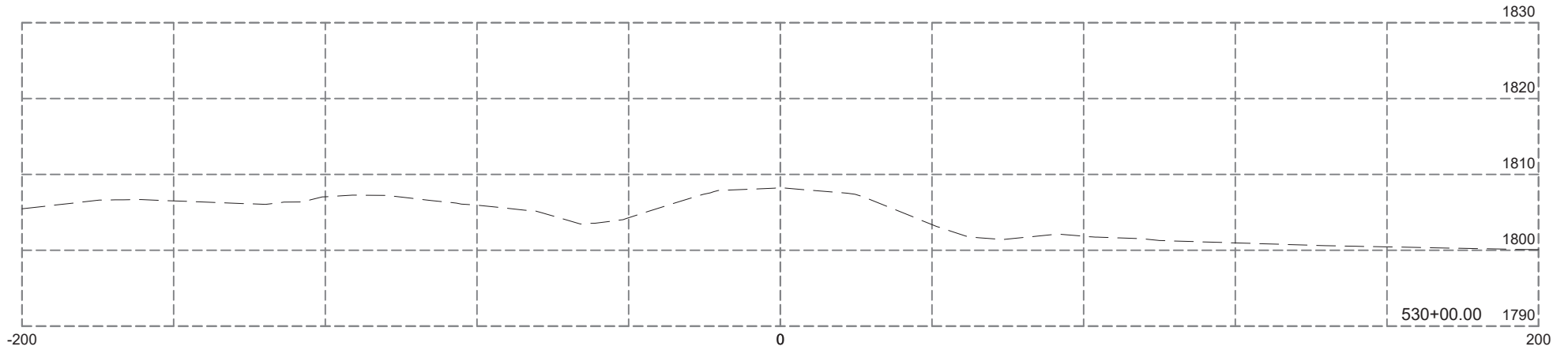

Plotting Date: 12-04-2024

STATE OF SOUTH DAKOTA	PROJECT P-PH-PT 0025(81)158	SHEET X4	TOTAL SHEETS X99
-----------------------	--------------------------------	-------------	---------------------

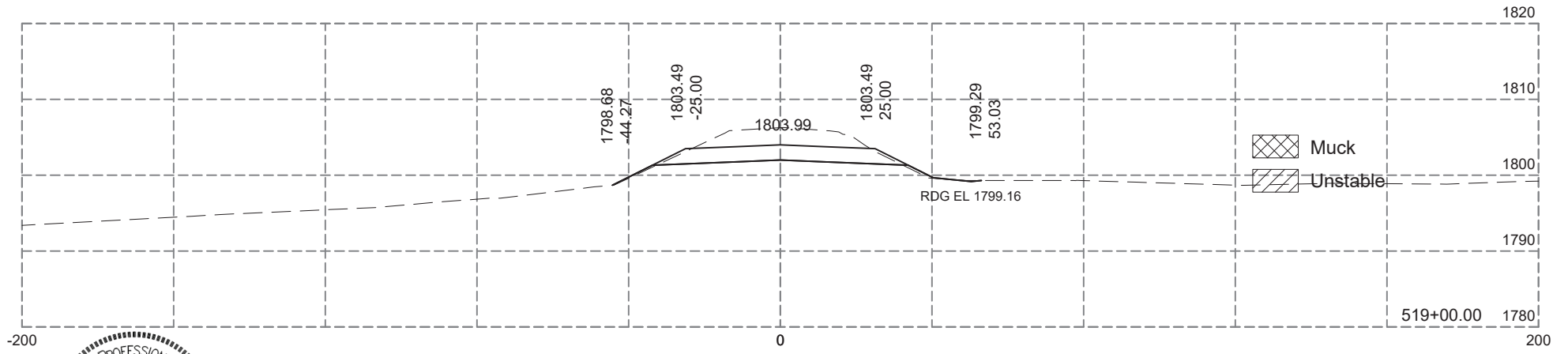
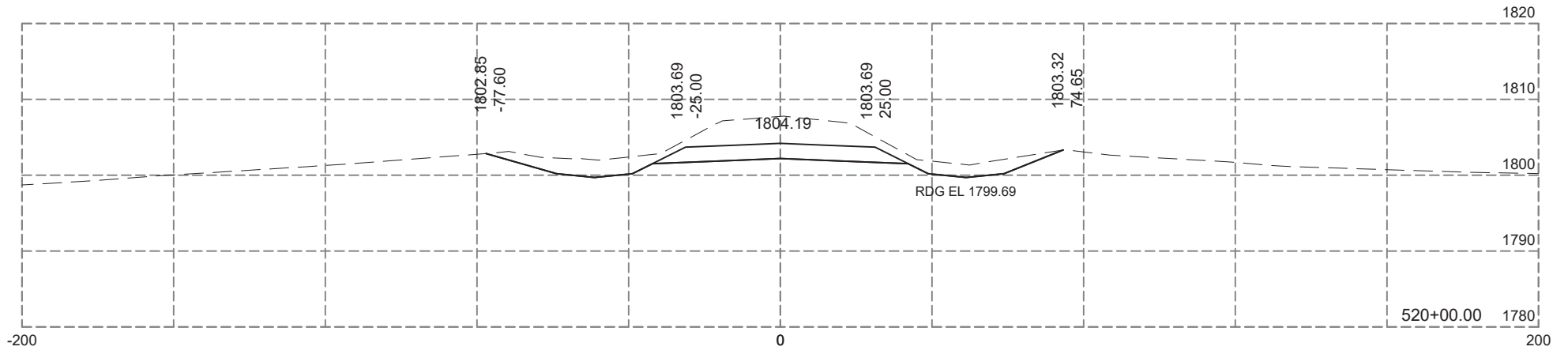
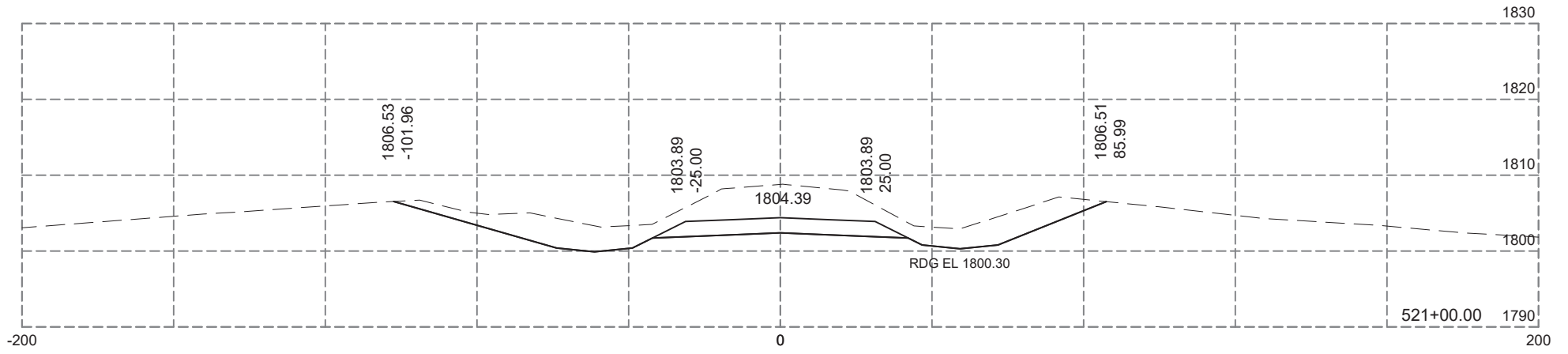
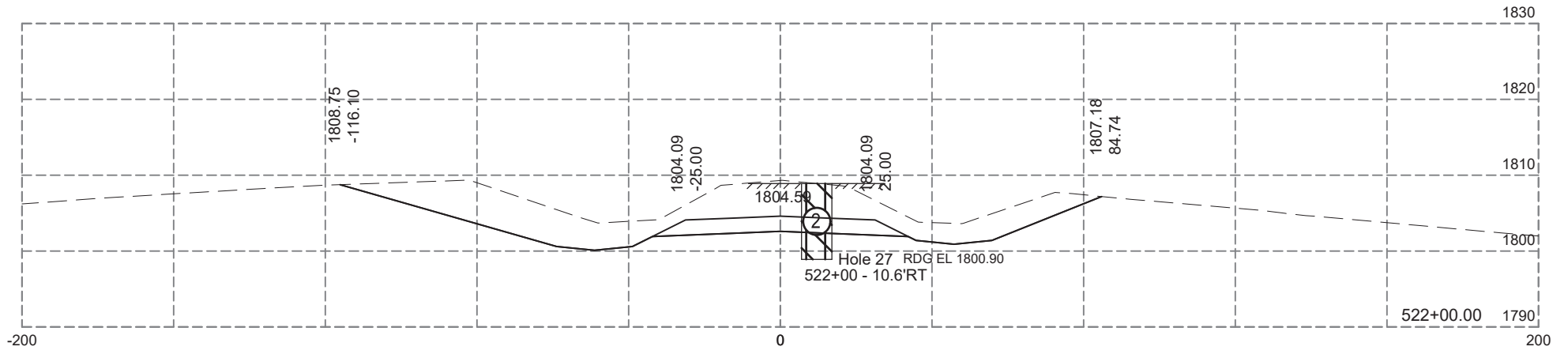
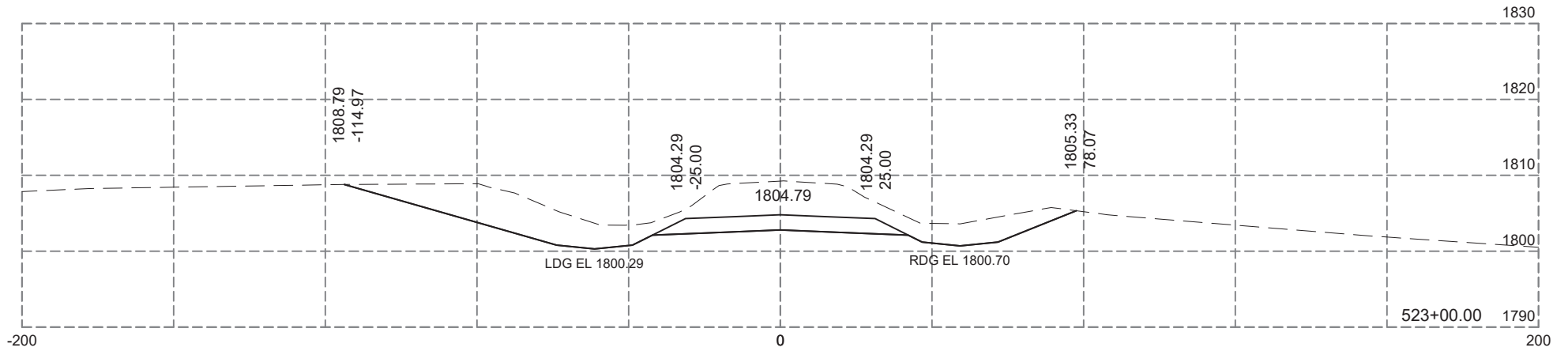
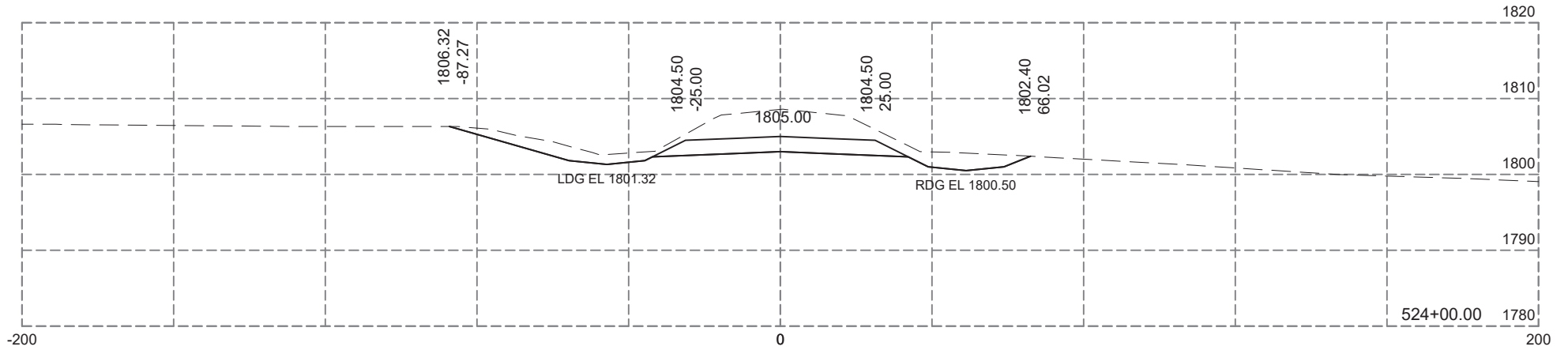

Plotting Date: 12-04-2024

STATE OF SOUTH DAKOTA	PROJECT	SHEET	TOTAL SHEETS
	P-PH-PT 0025(81)158	X5	X99

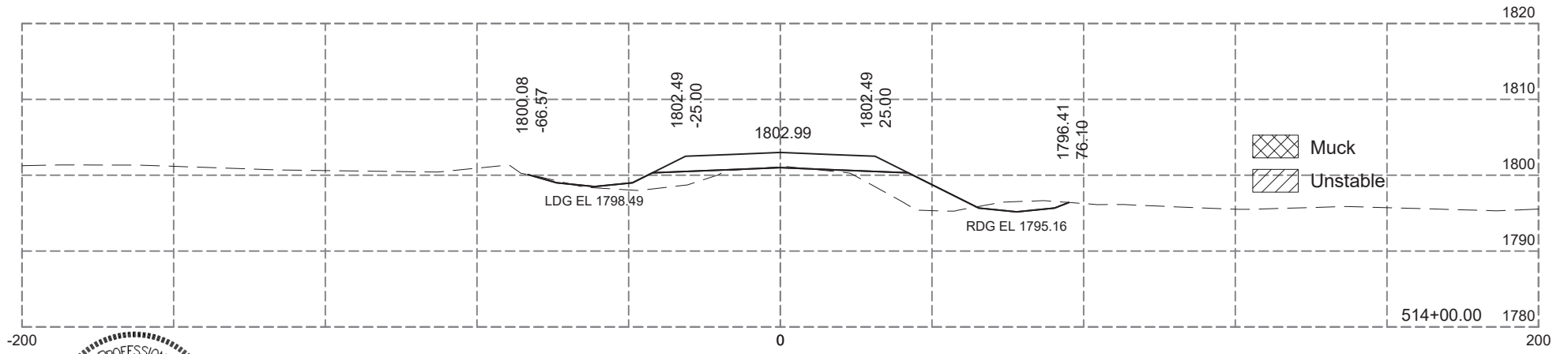
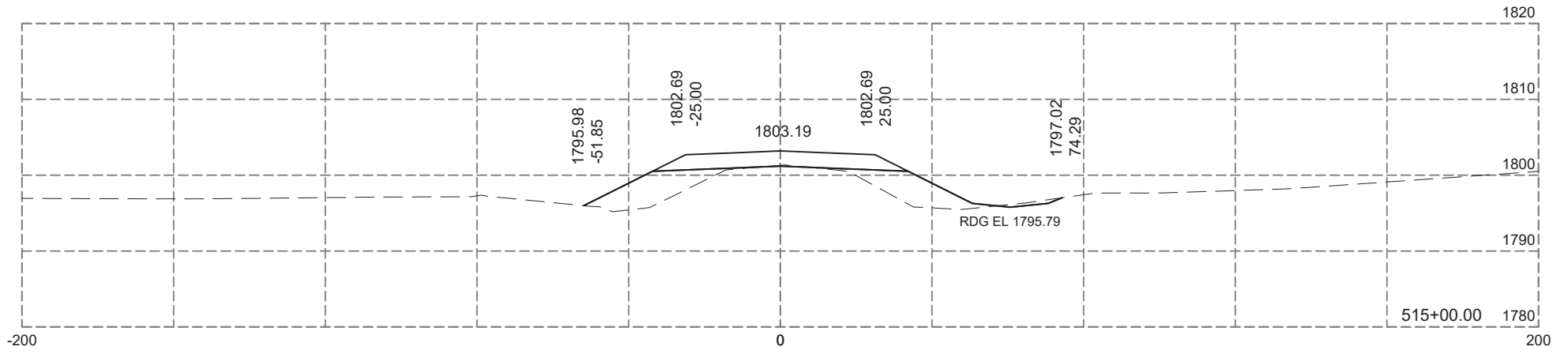
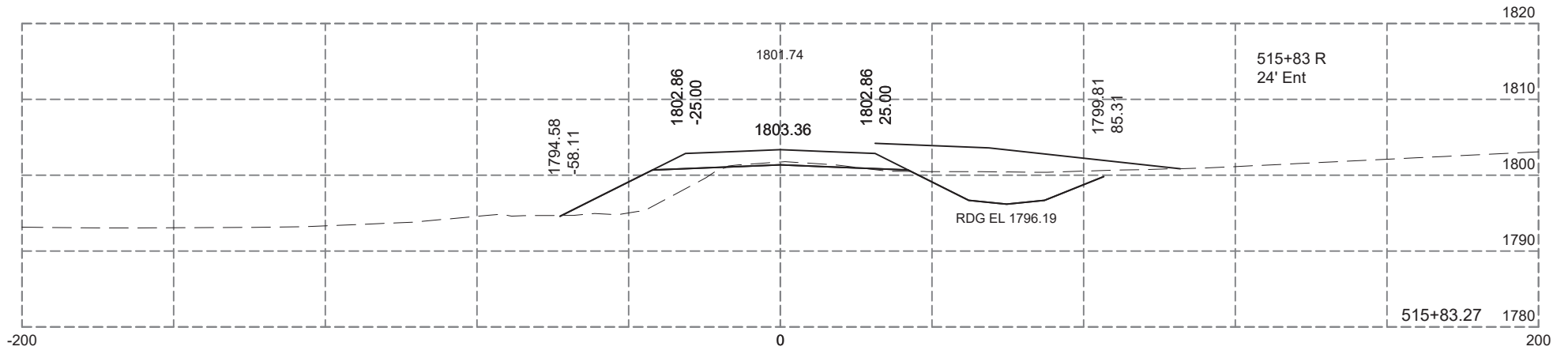
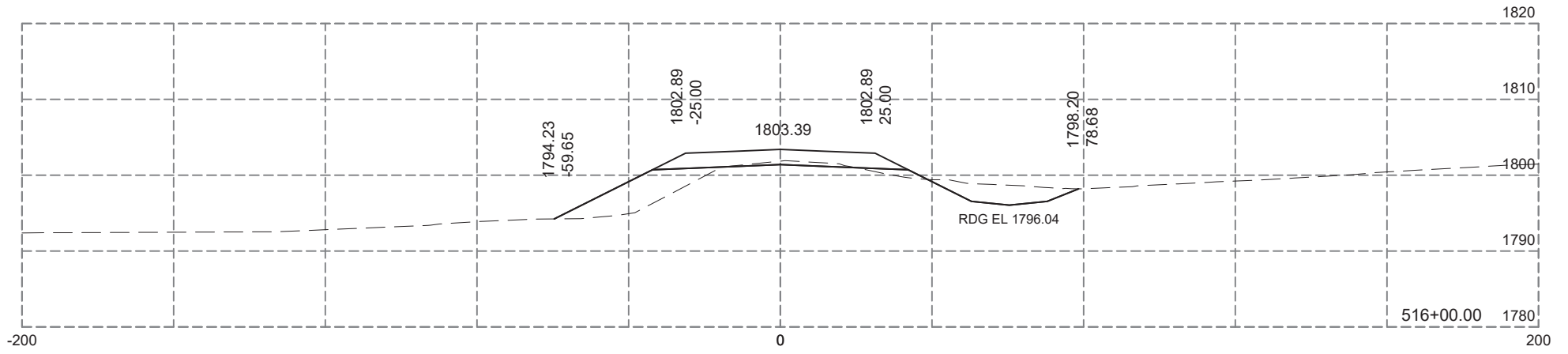
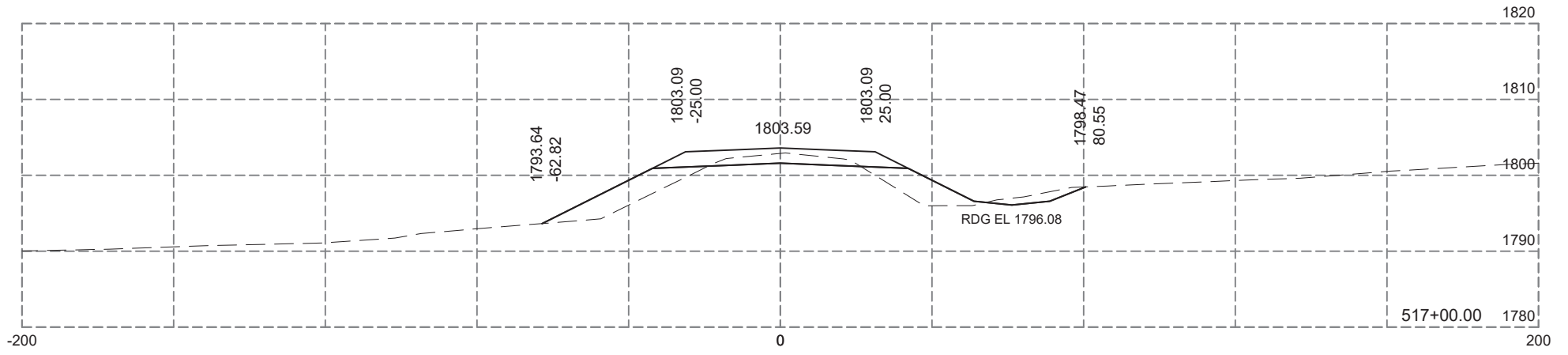
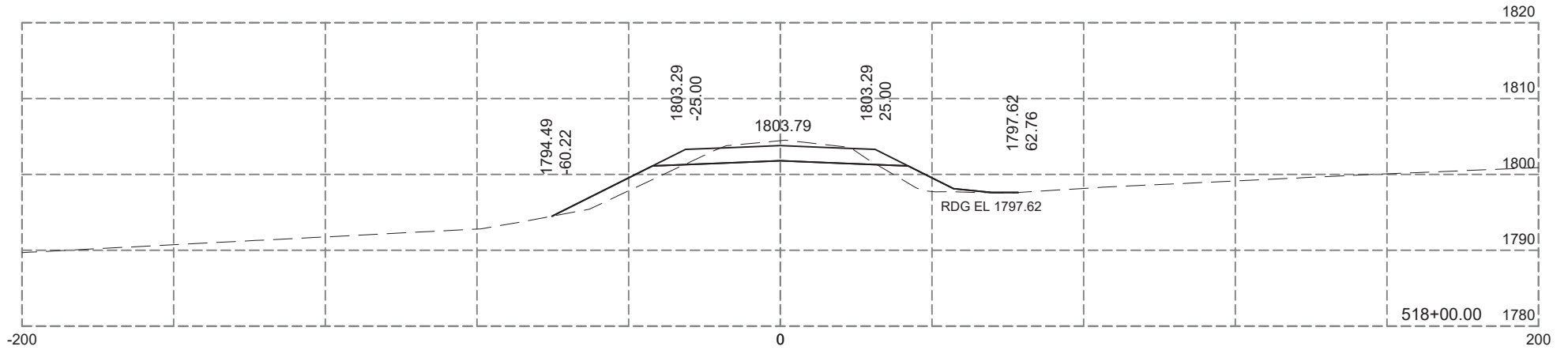

Plotting Date: 12-04-2024

STATE OF SOUTH DAKOTA	PROJECT P-PH-PT 0025(81)158	SHEET X6	TOTAL SHEETS X99
-----------------------	--------------------------------	-------------	---------------------

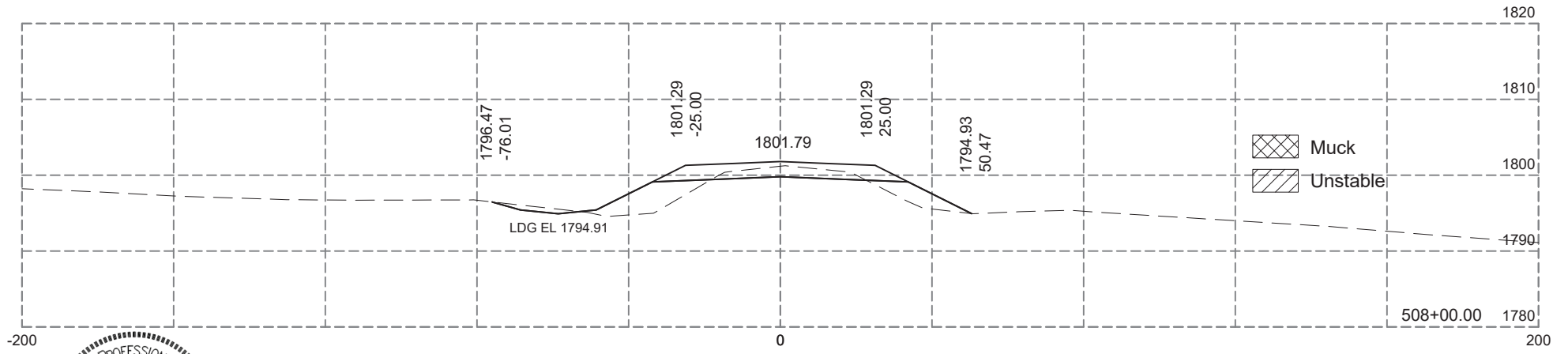
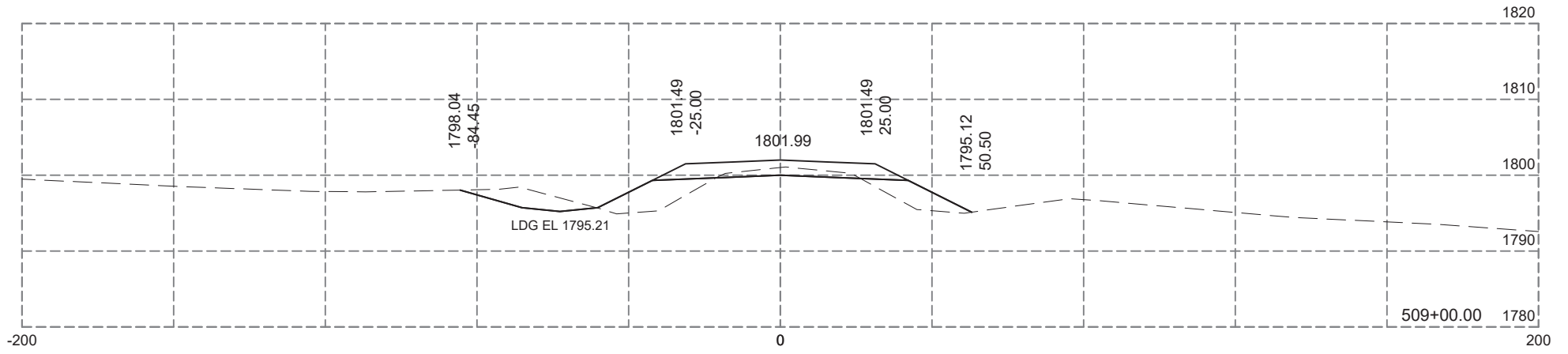
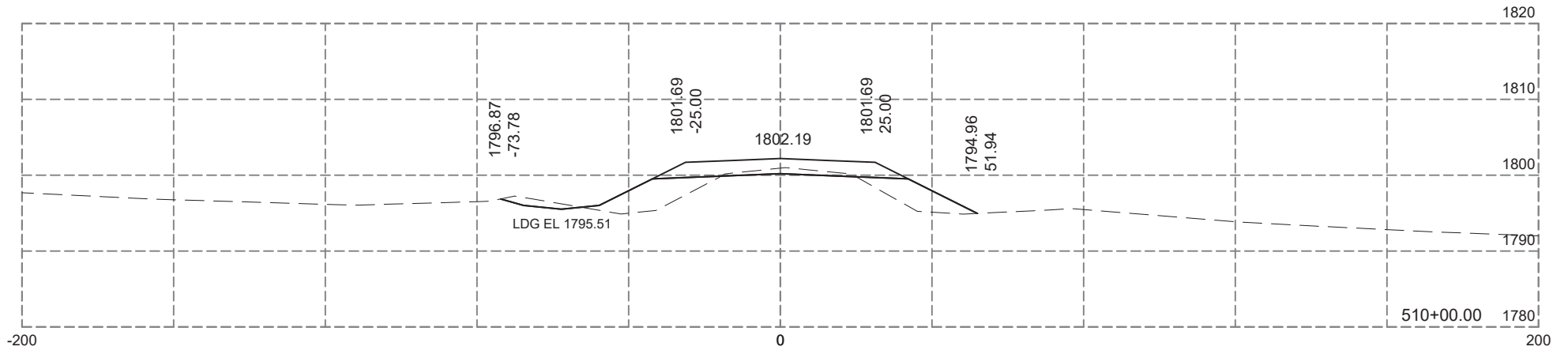
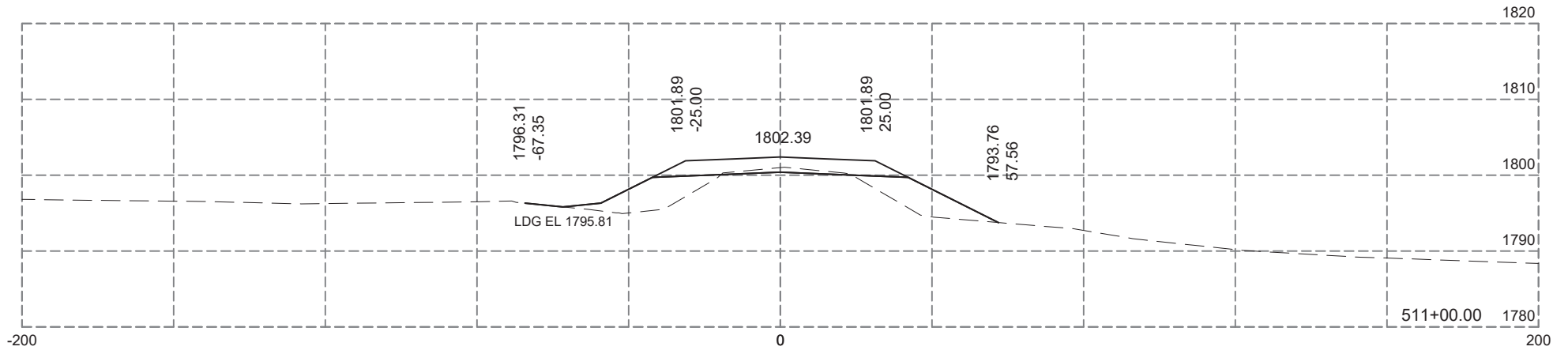
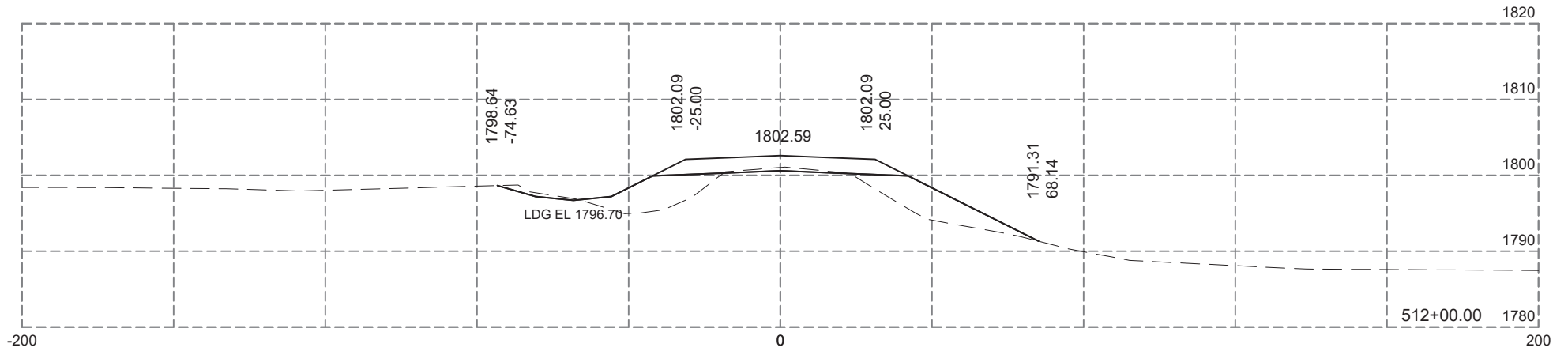
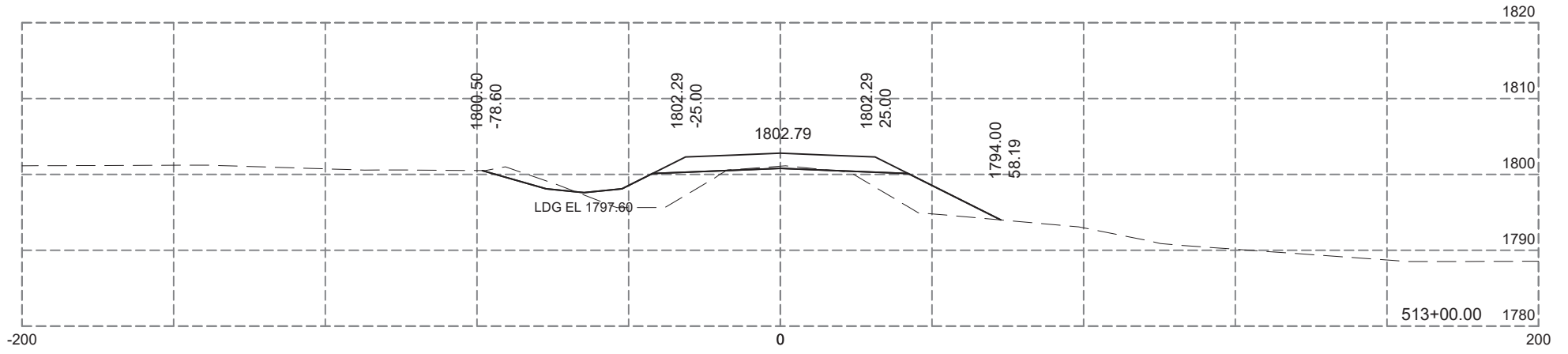

 Muck  
 Unstable



Plotting Date: 12-04-2024

STATE OF SOUTH DAKOTA	PROJECT	SHEET	TOTAL SHEETS
	P-PH-PT 0025(81)158	X7	X99

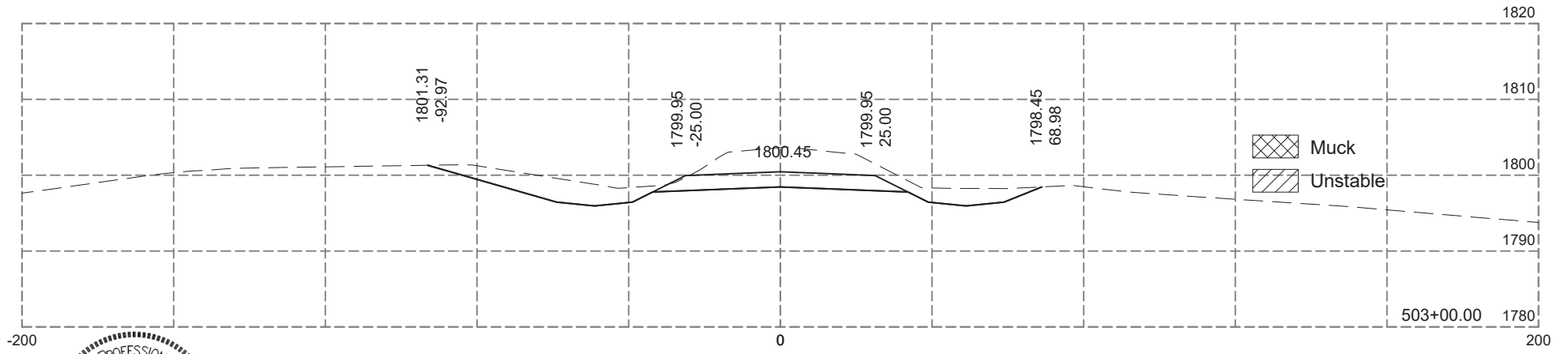
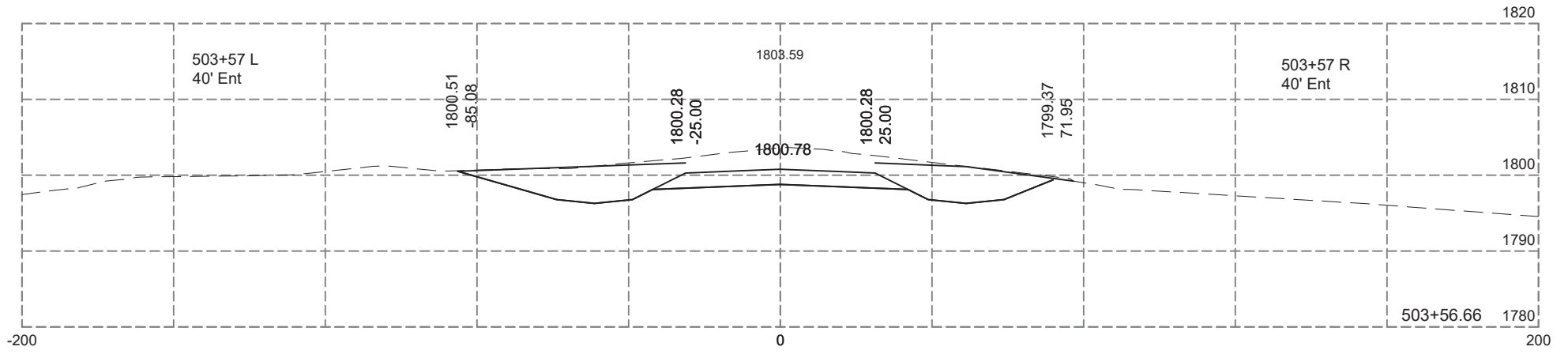
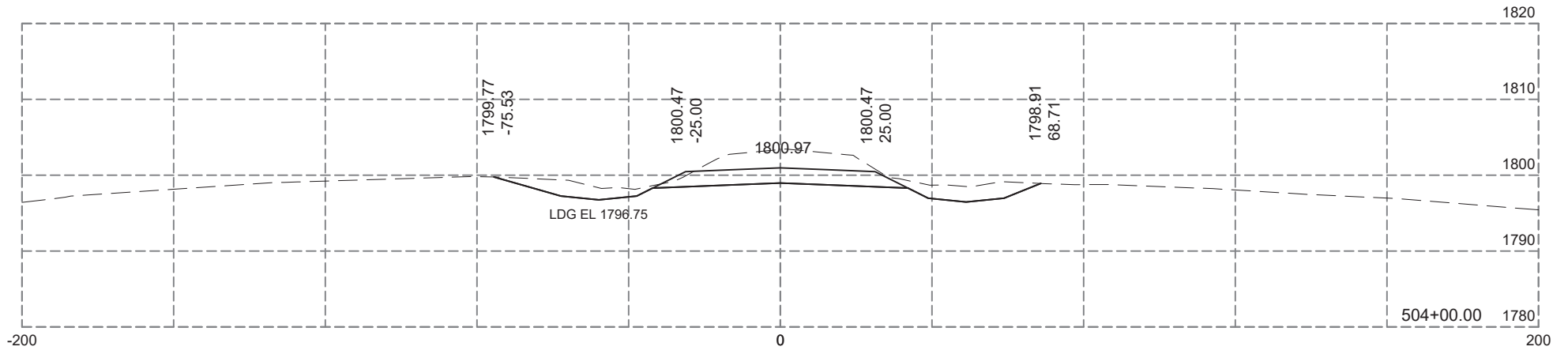
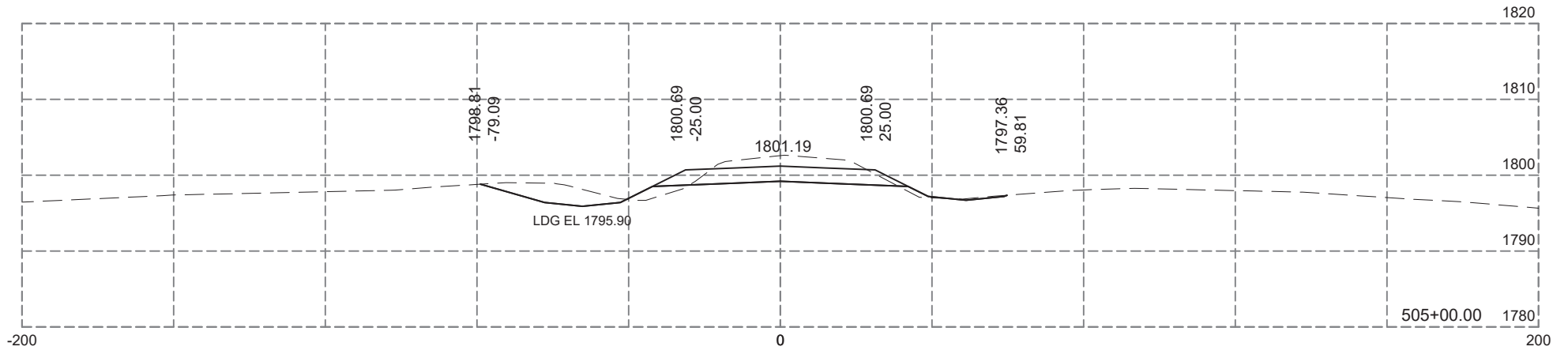
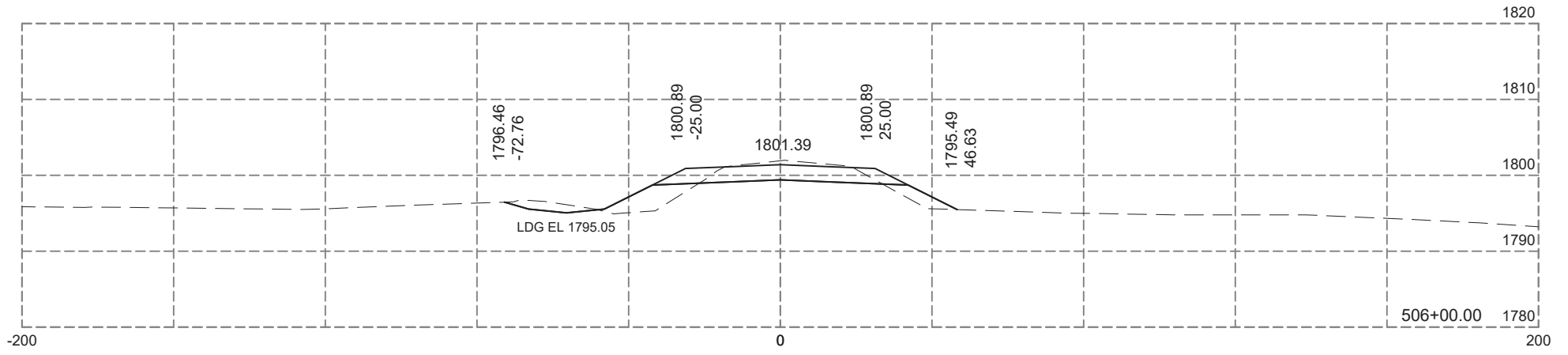
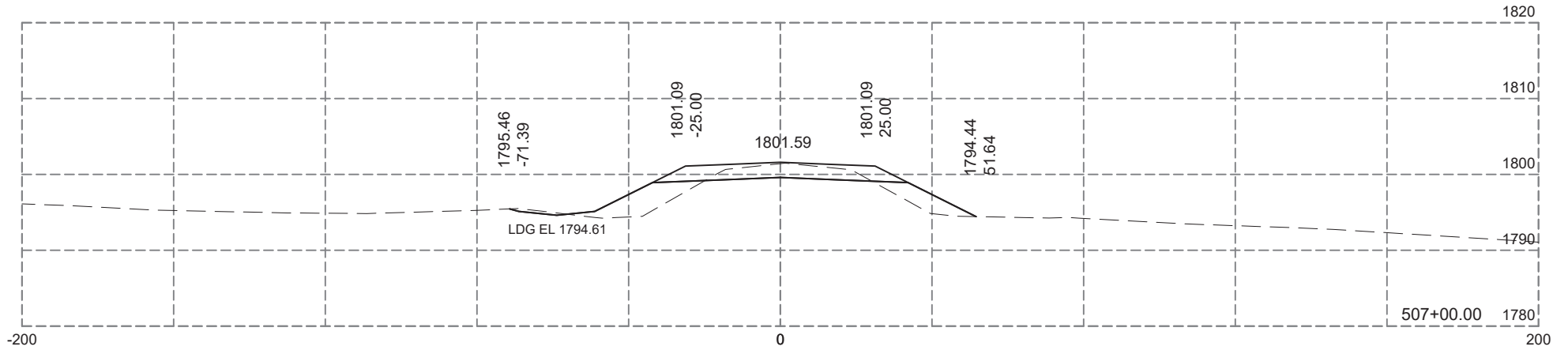

Muck  
 Unstable



Plotting Date: 12-04-2024

STATE OF SOUTH DAKOTA	PROJECT	SHEET	TOTAL SHEETS
	P-PH-PT 0025(81)158	X8	X99



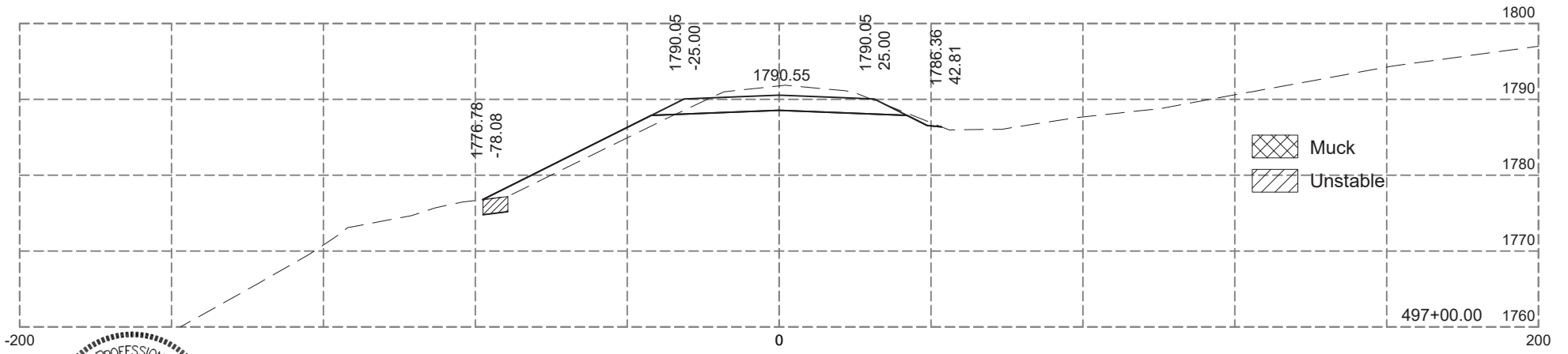
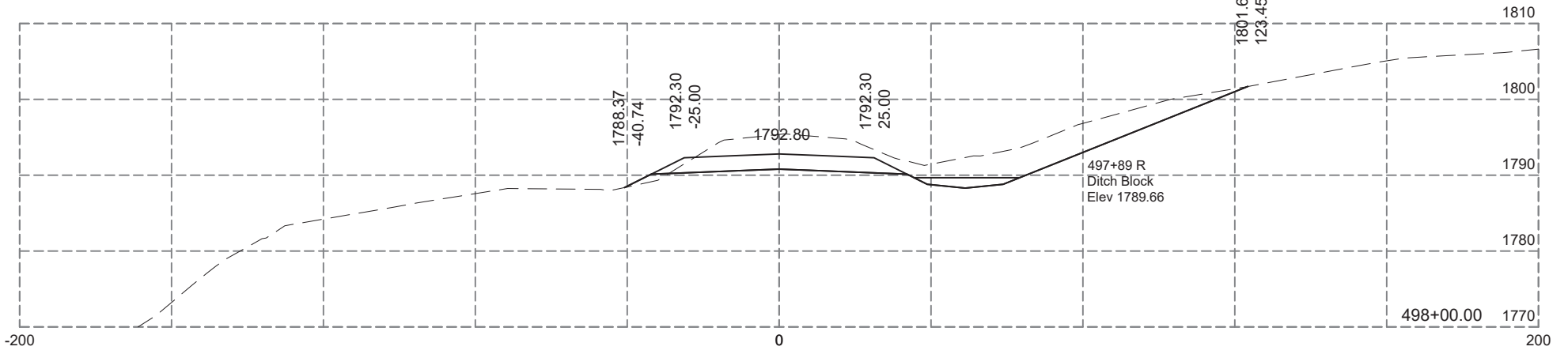
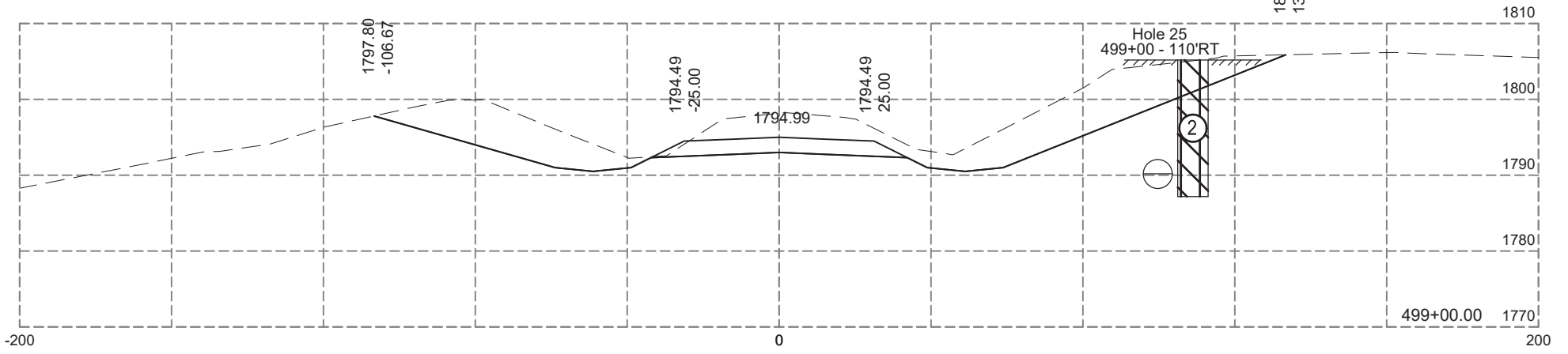
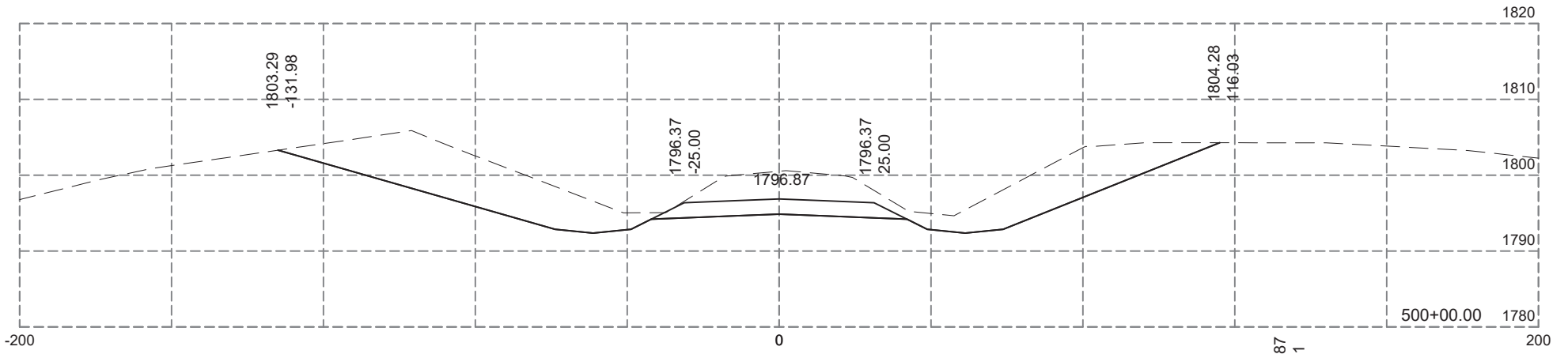
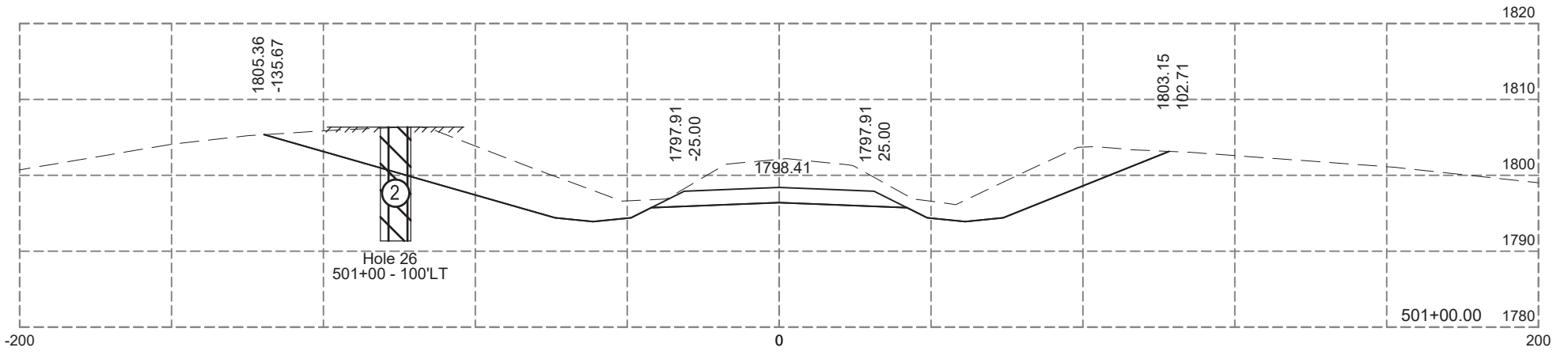
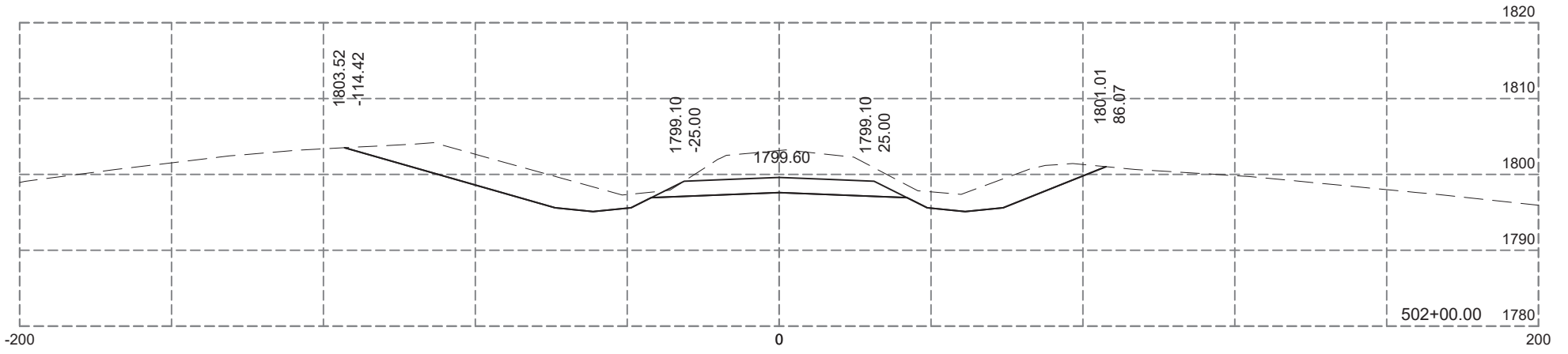

 Muck  
 Unstable



Plotting Date: 12-04-2024

STATE OF SOUTH DAKOTA	PROJECT P-PH-PT 0025(81)158	SHEET X9	TOTAL SHEETS X99
-----------------------	--------------------------------	-------------	---------------------

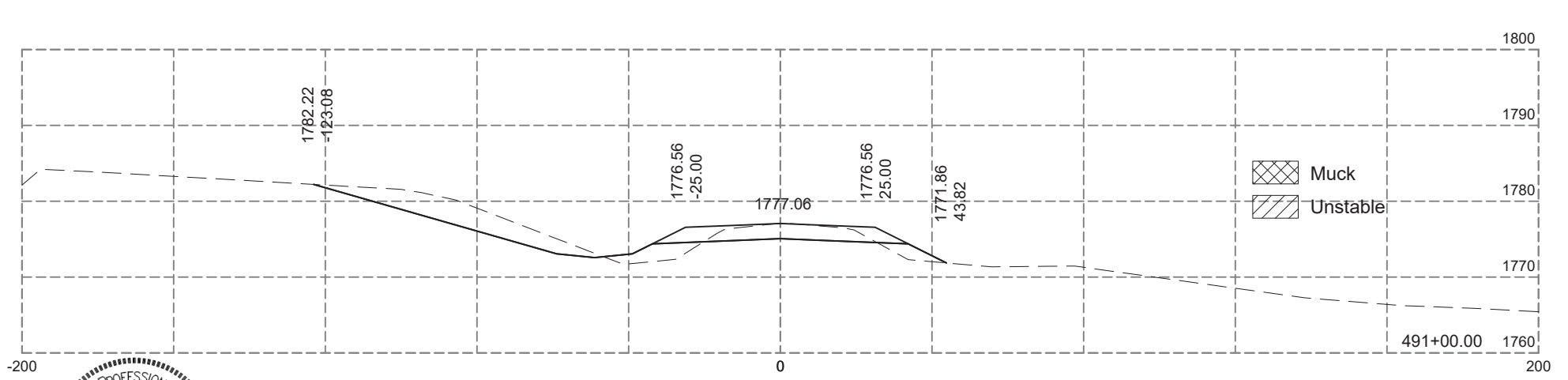
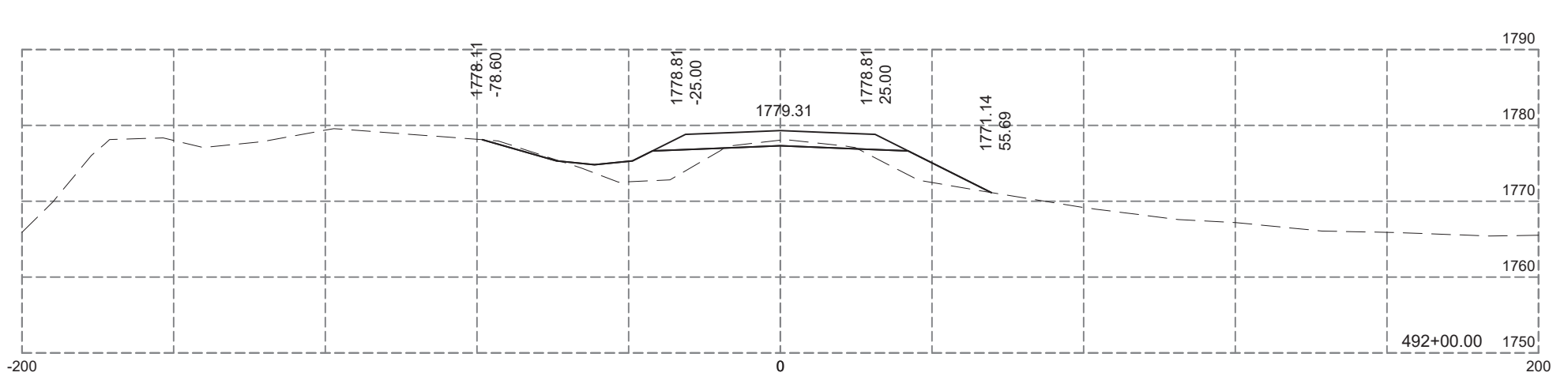
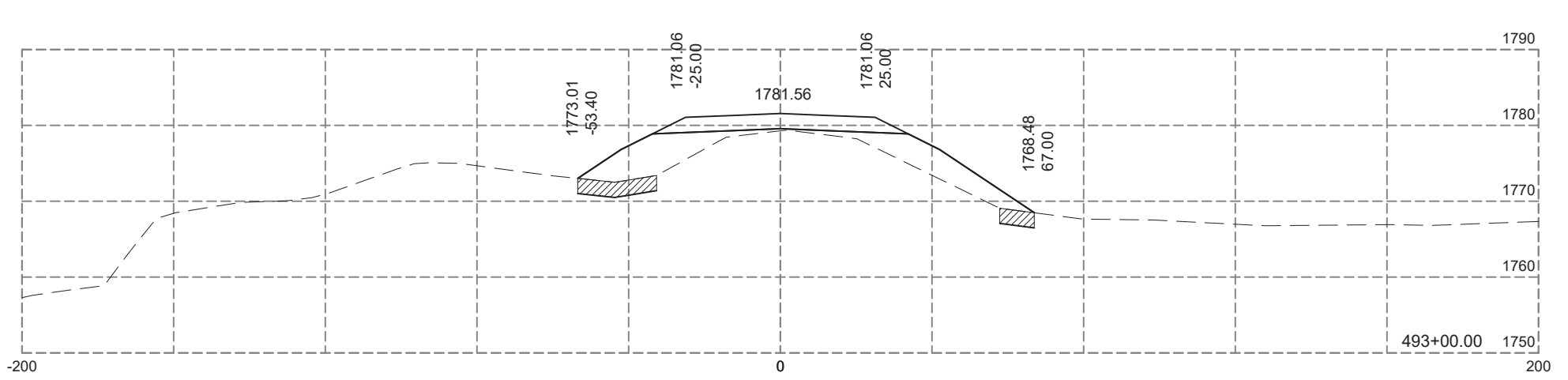
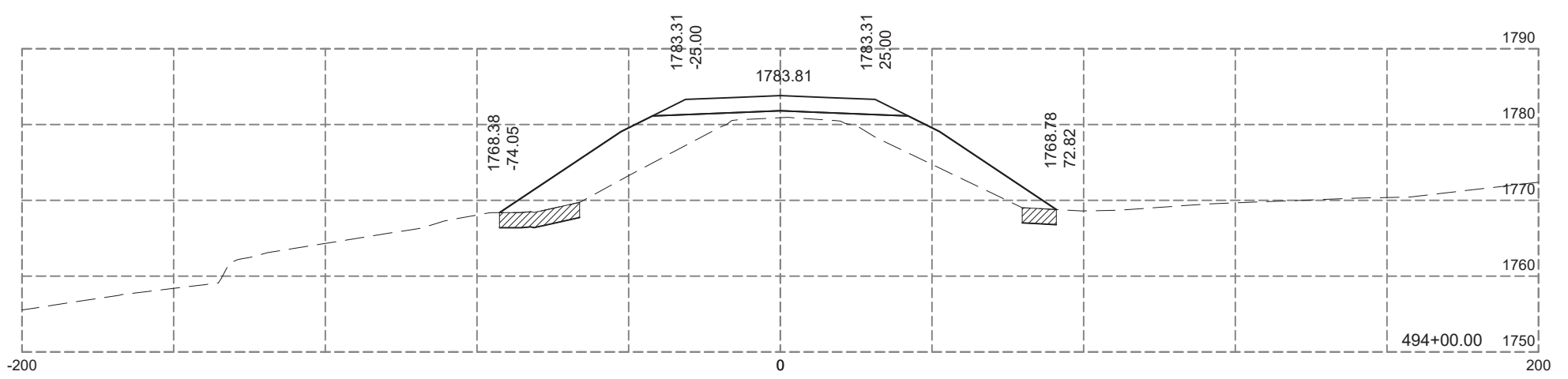
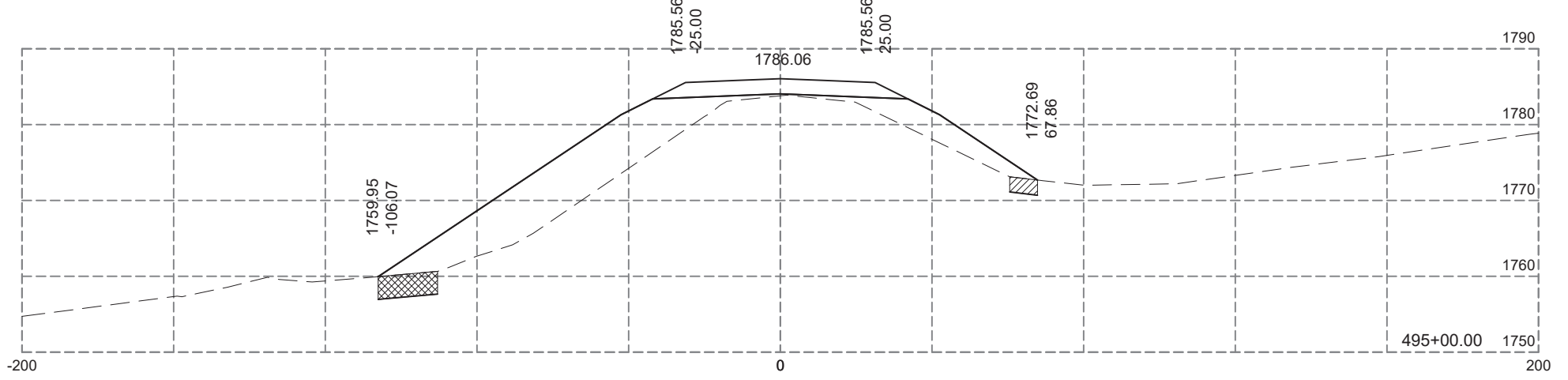
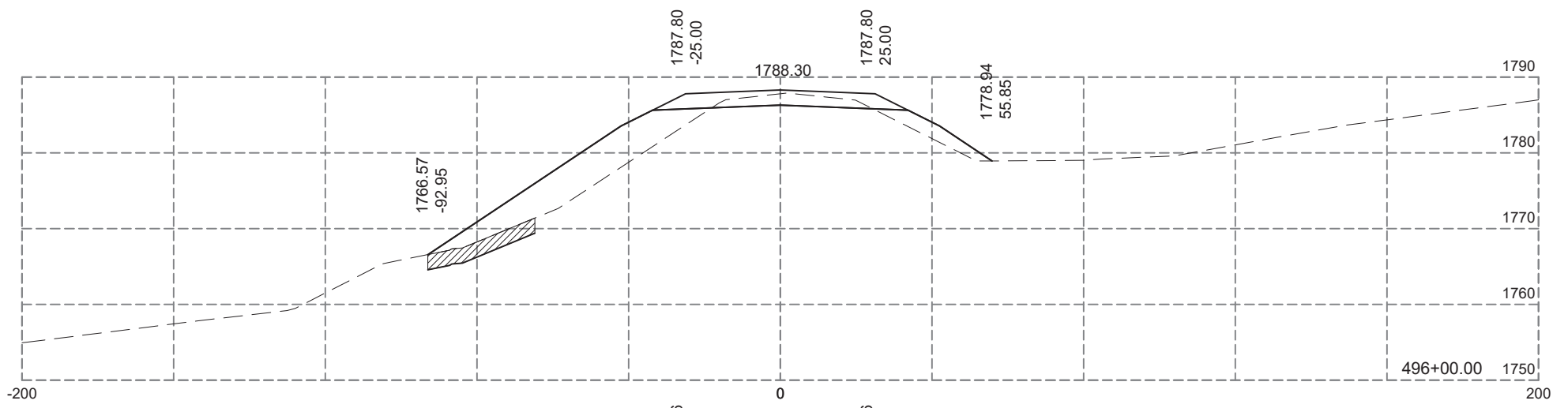

Muck  
 Unstable



Plotting Date: 12-04-2024

STATE OF SOUTH DAKOTA	PROJECT	SHEET	TOTAL SHEETS
	P-PH-PT 0025(81)158	X10	X99

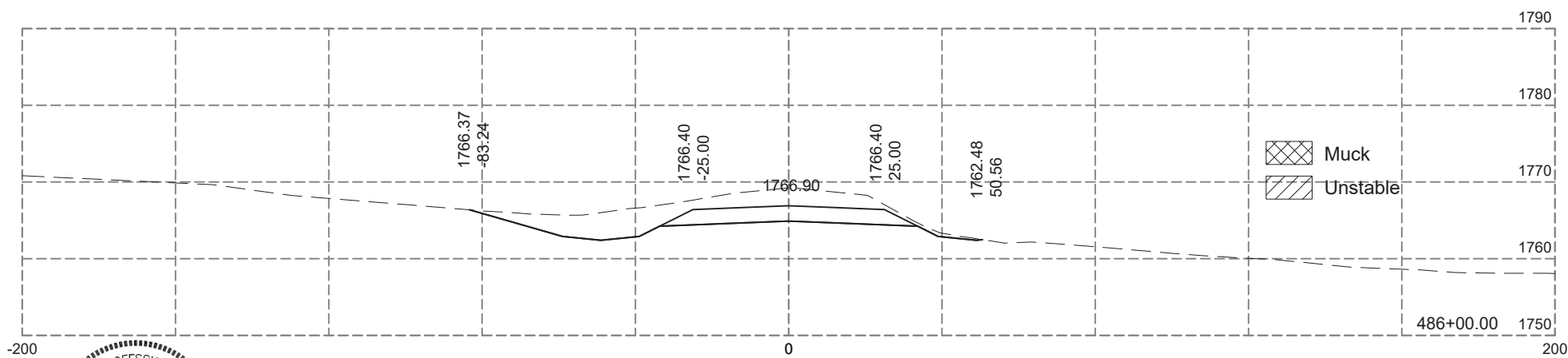
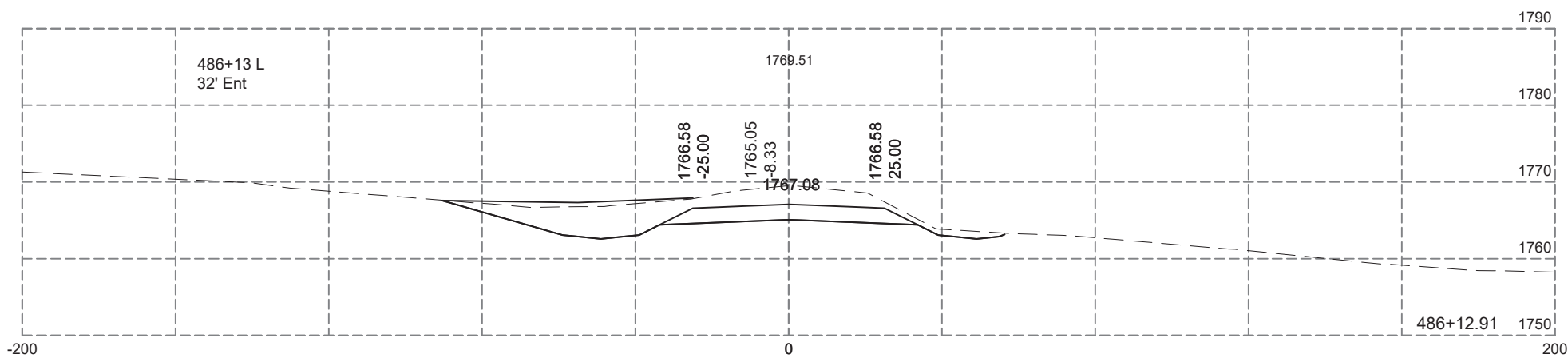
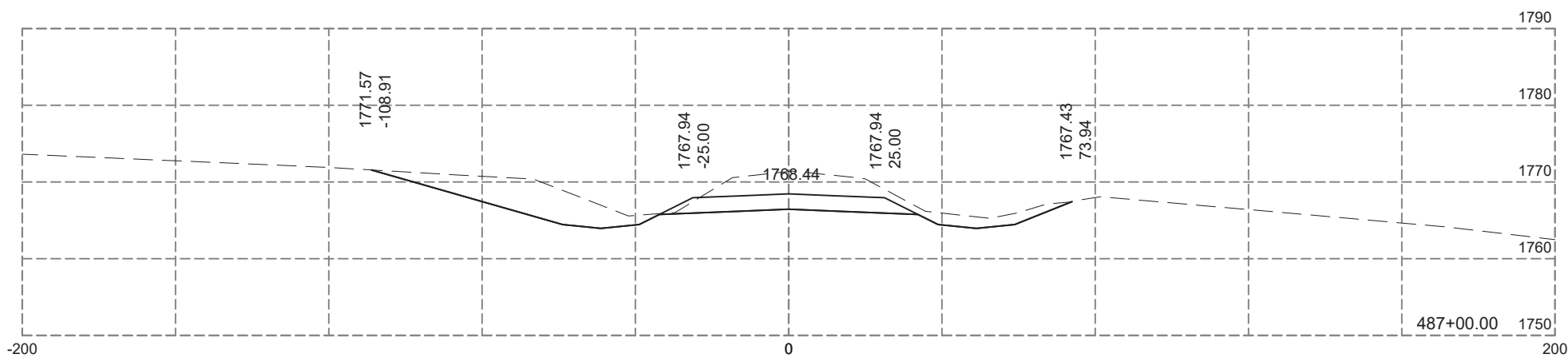
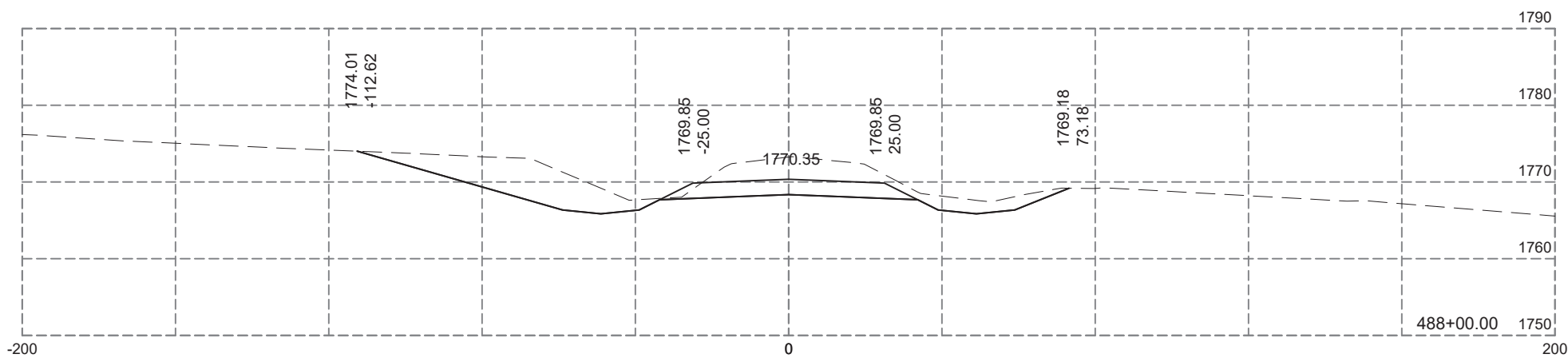
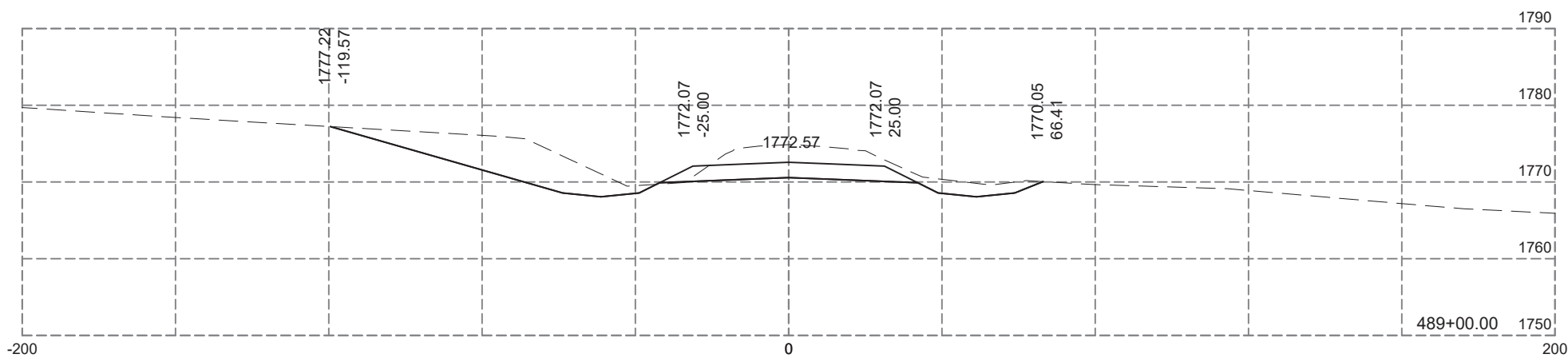
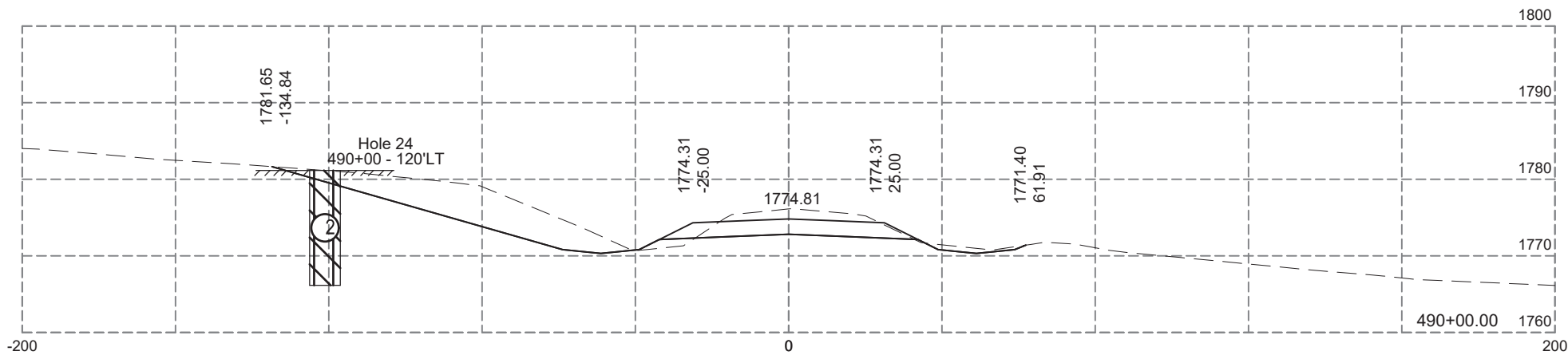

Plotting Date: 12-04-2024

STATE OF SOUTH DAKOTA	PROJECT P-PH-PT 0025(81)158	SHEET X11	TOTAL SHEETS X99
-----------------------	--------------------------------	--------------	---------------------

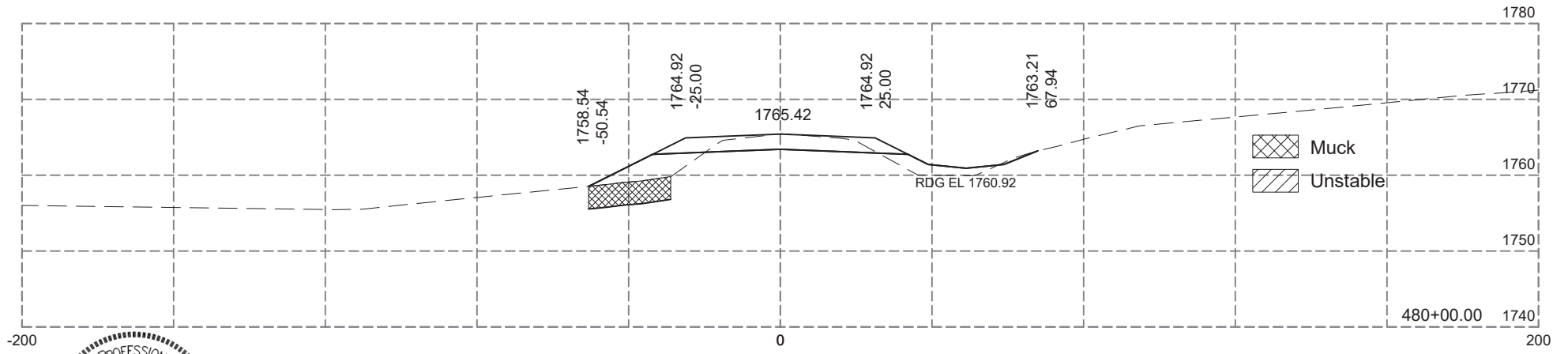
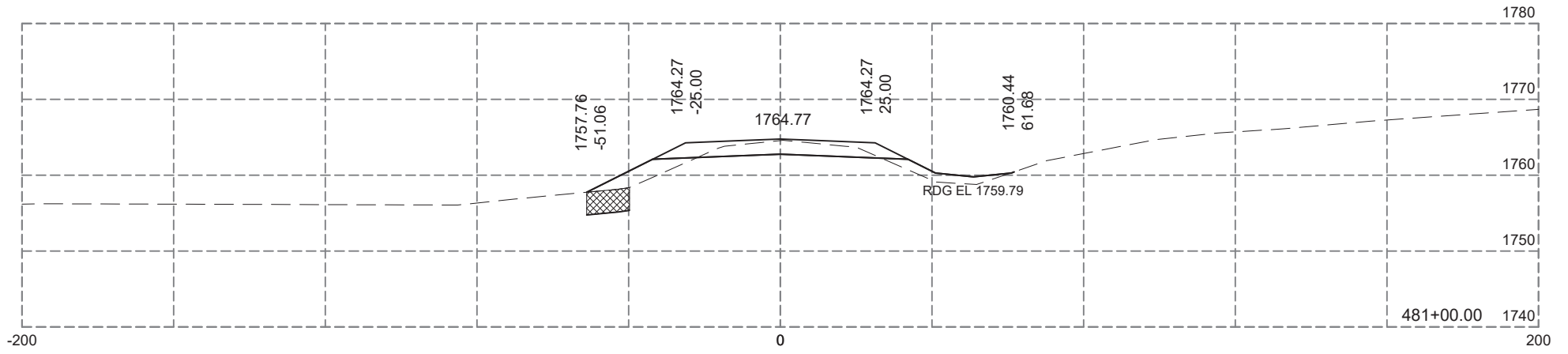
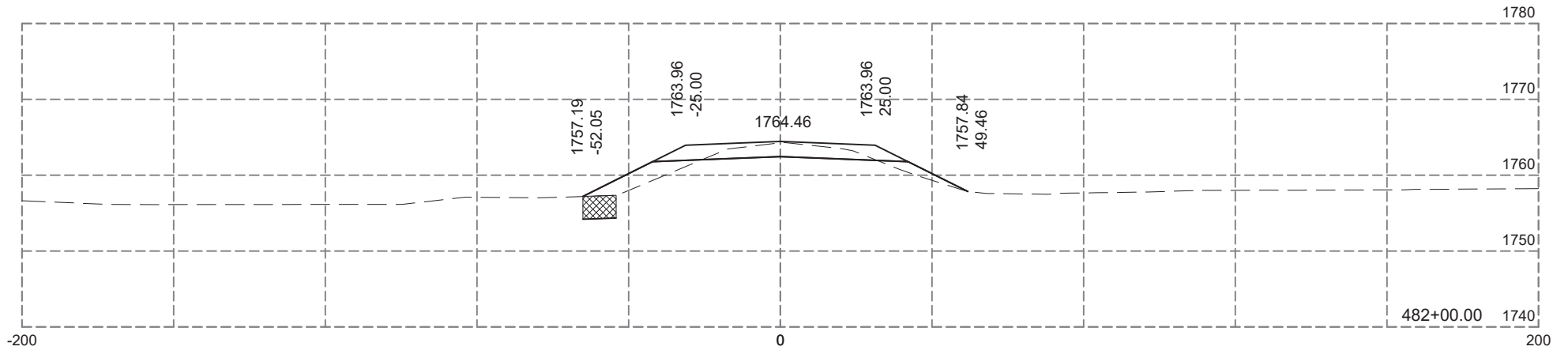
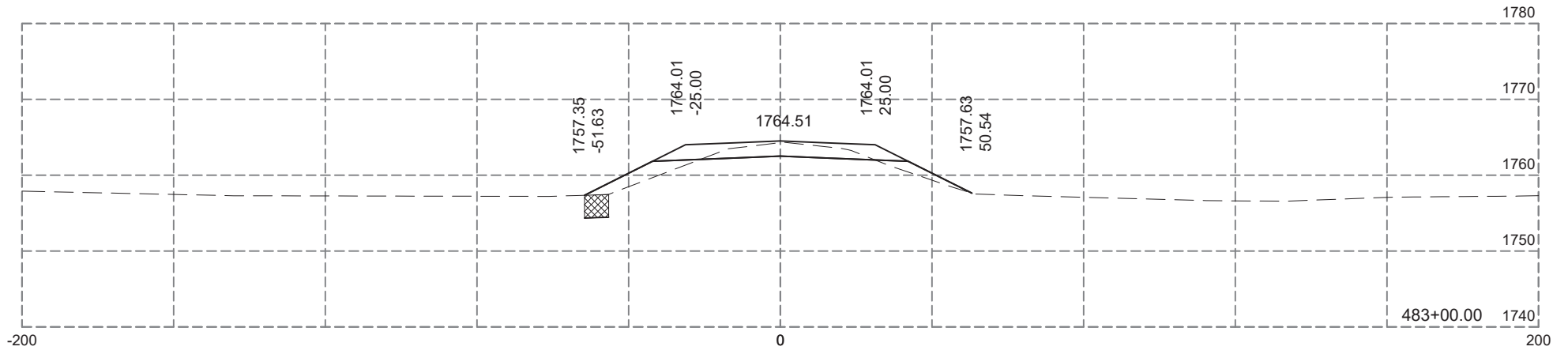
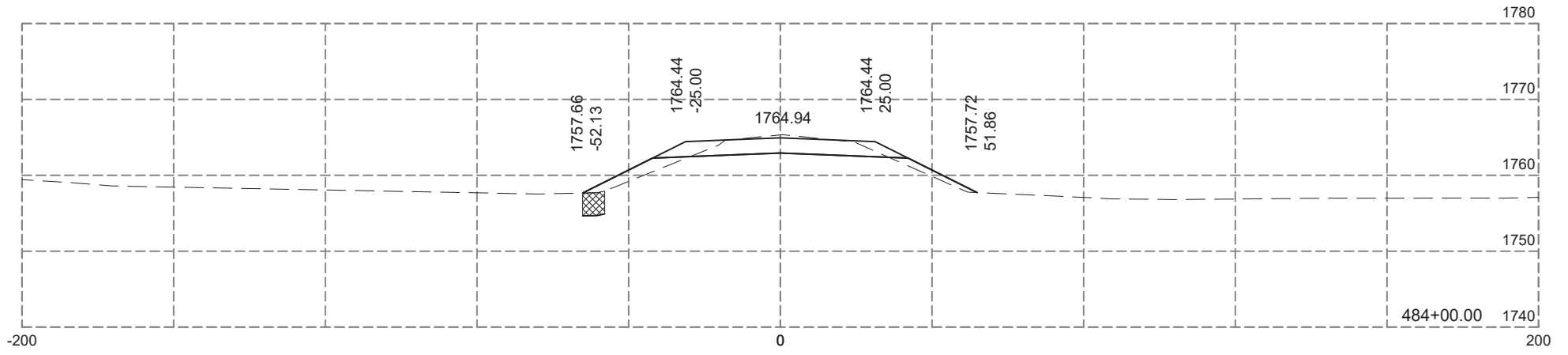
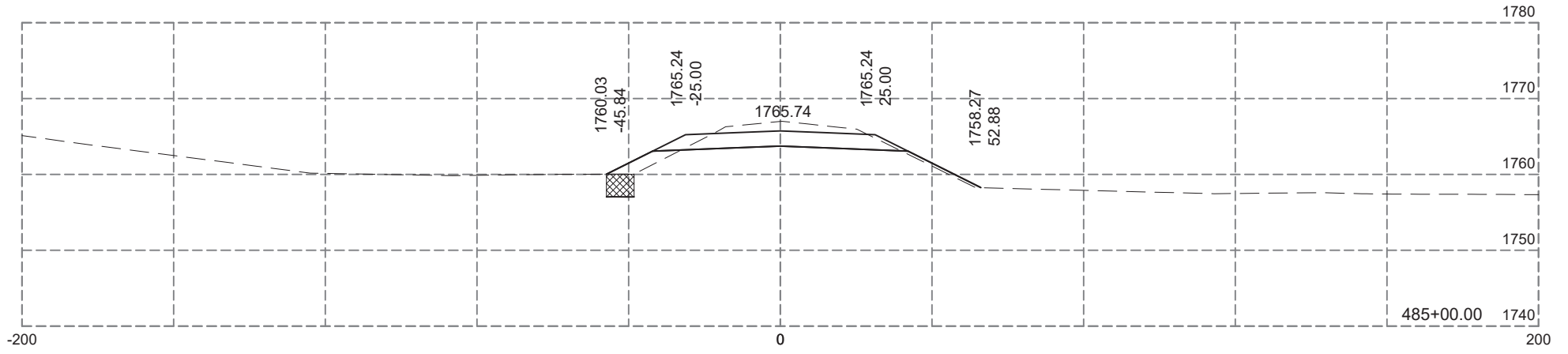

Muck  
 Unstable



Plotting Date: 12-04-2024

STATE OF SOUTH DAKOTA	PROJECT	SHEET	TOTAL SHEETS
	P-PH-PT 0025(81)158	X12	X99

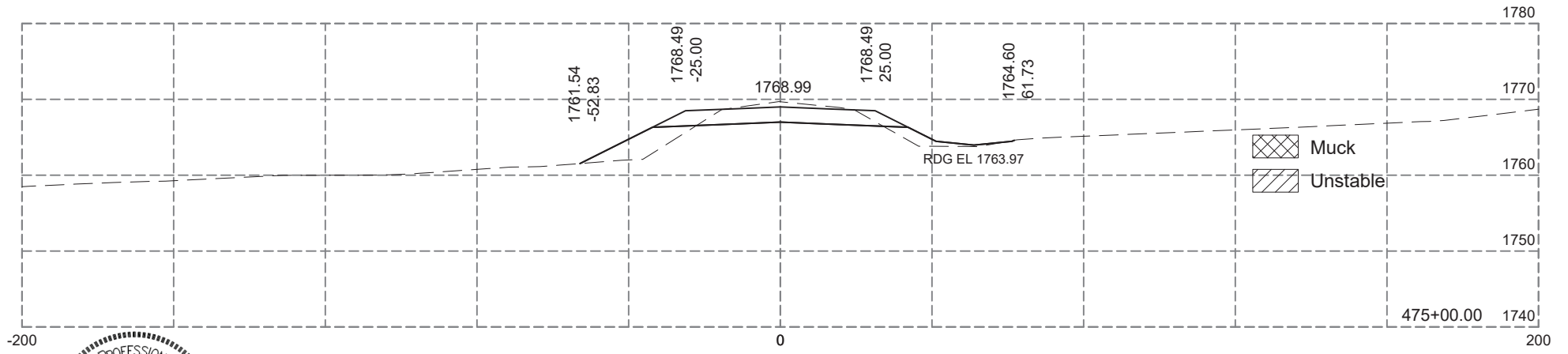
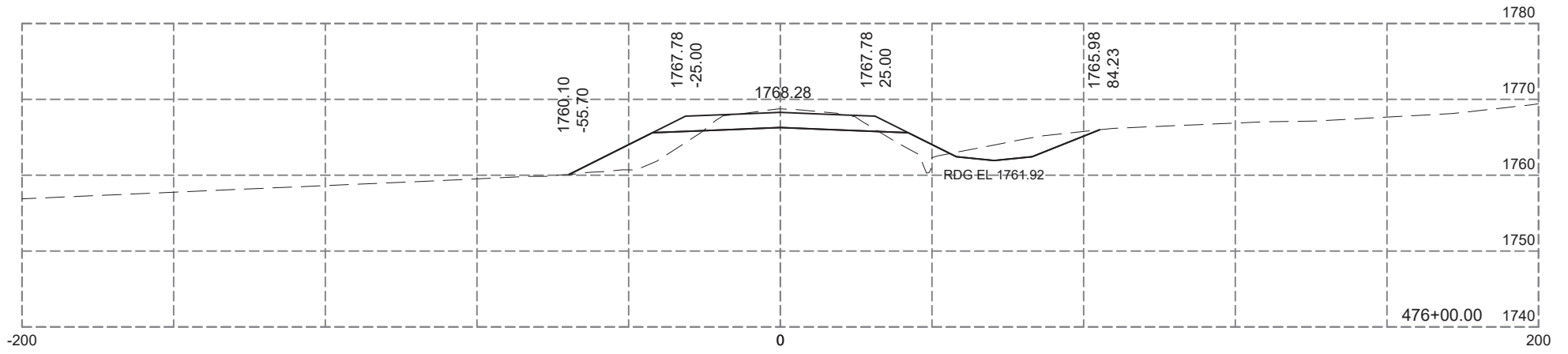
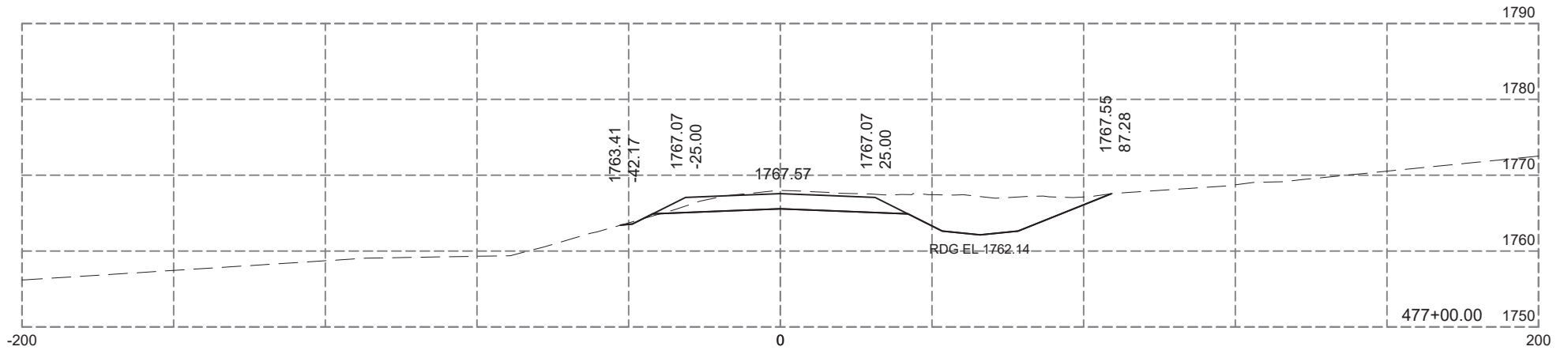
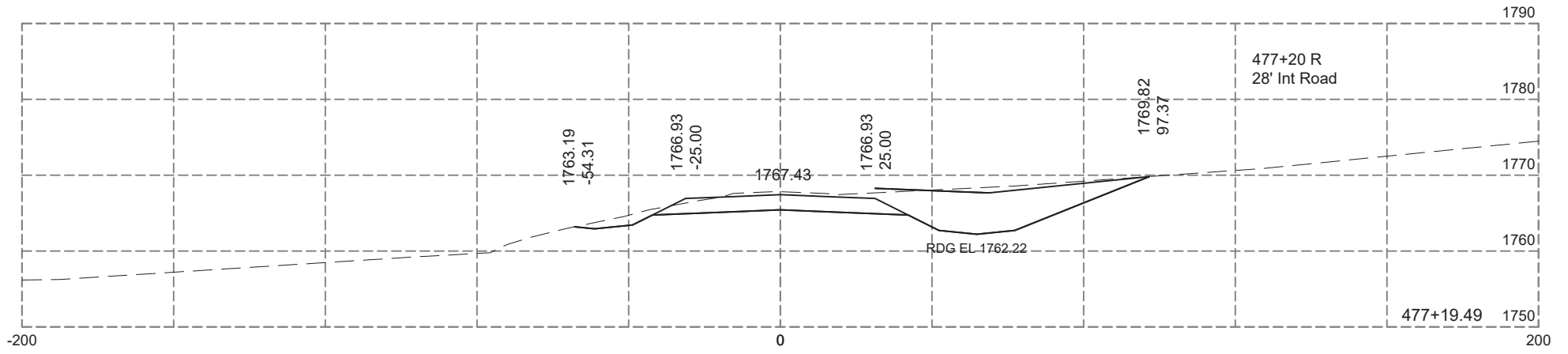
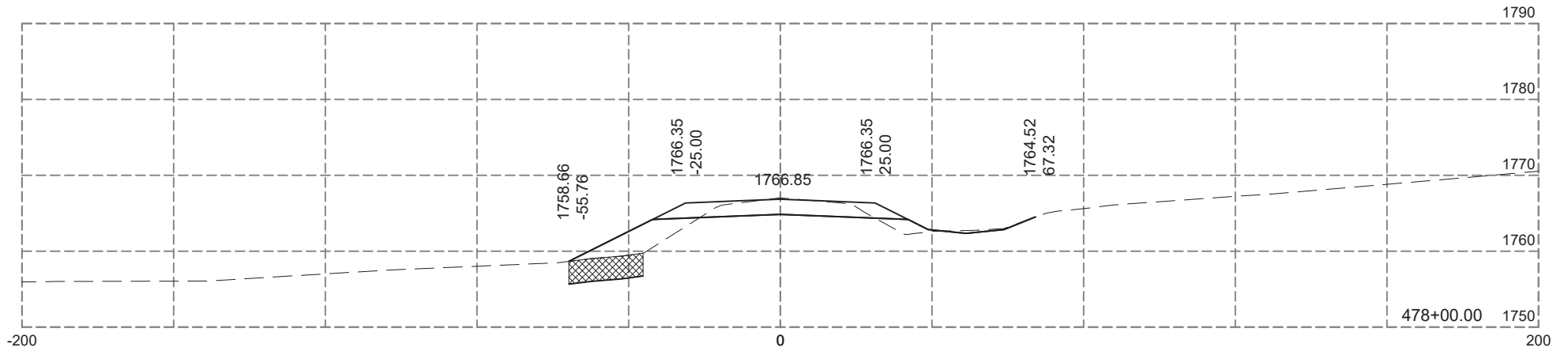
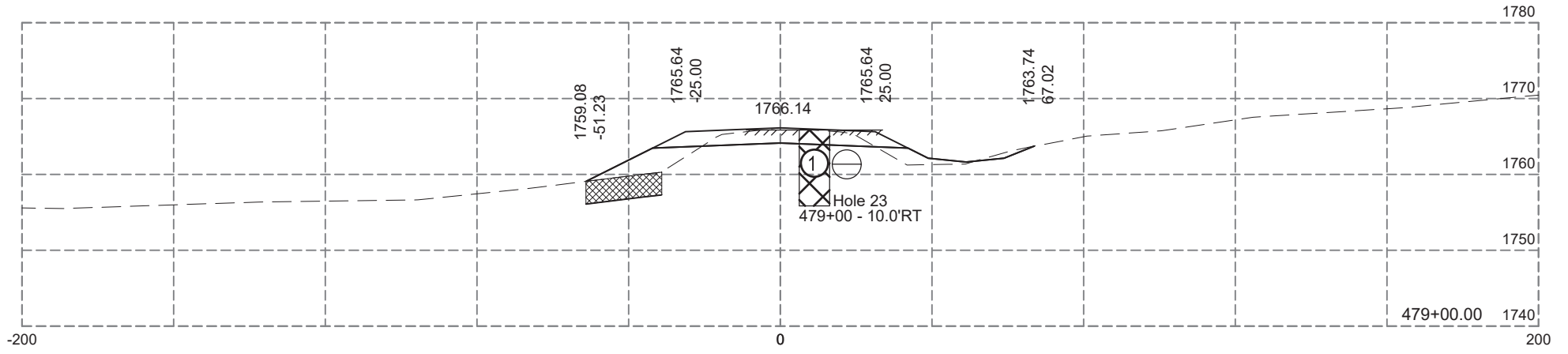

Plotting Date: 12-04-2024

STATE OF SOUTH DAKOTA	PROJECT P-PH-PT 0025(81)158	SHEET X13	TOTAL SHEETS X99
-----------------------	--------------------------------	--------------	---------------------

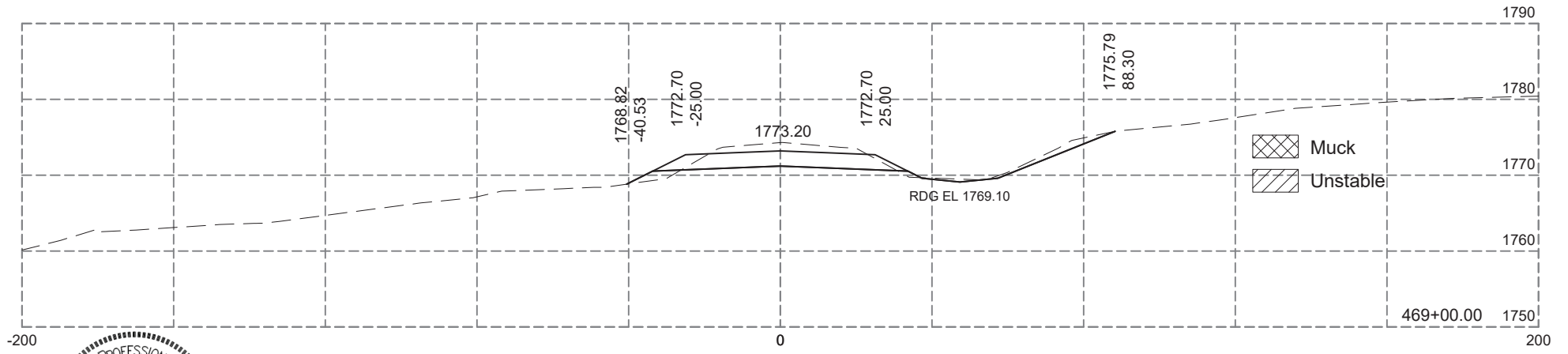
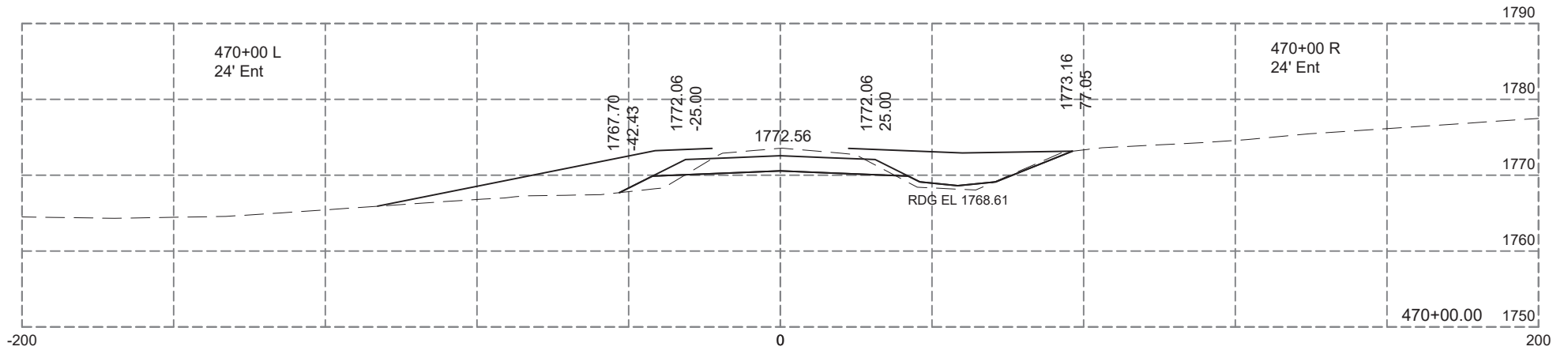
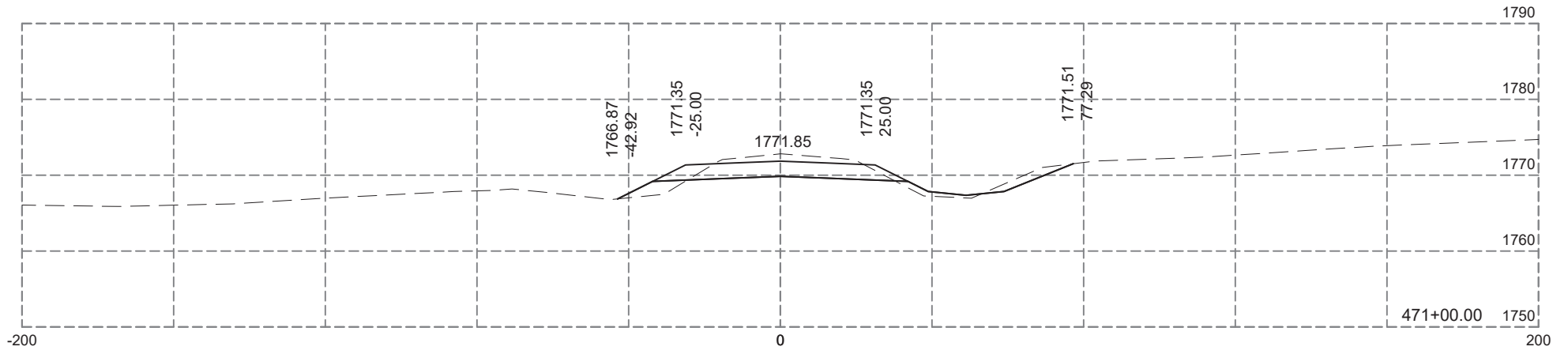
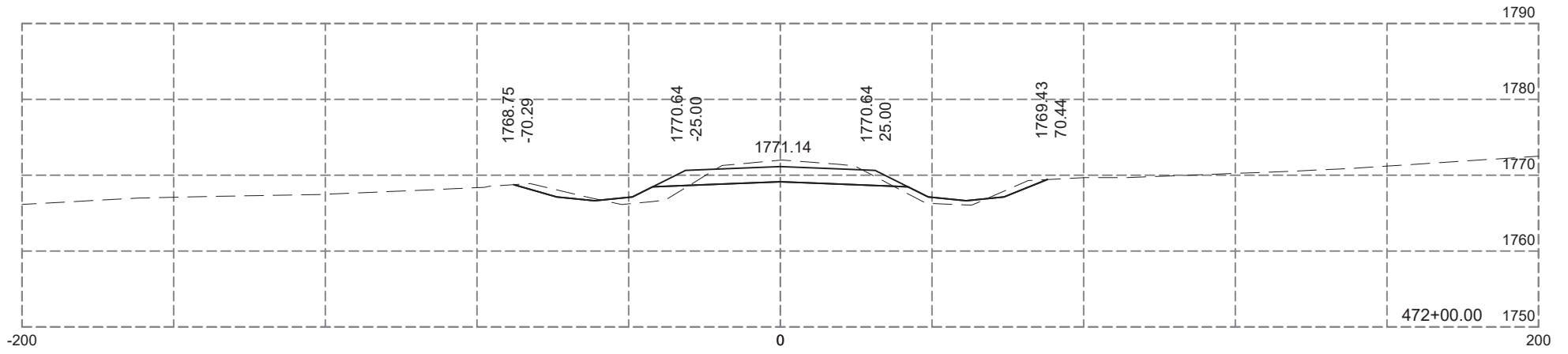
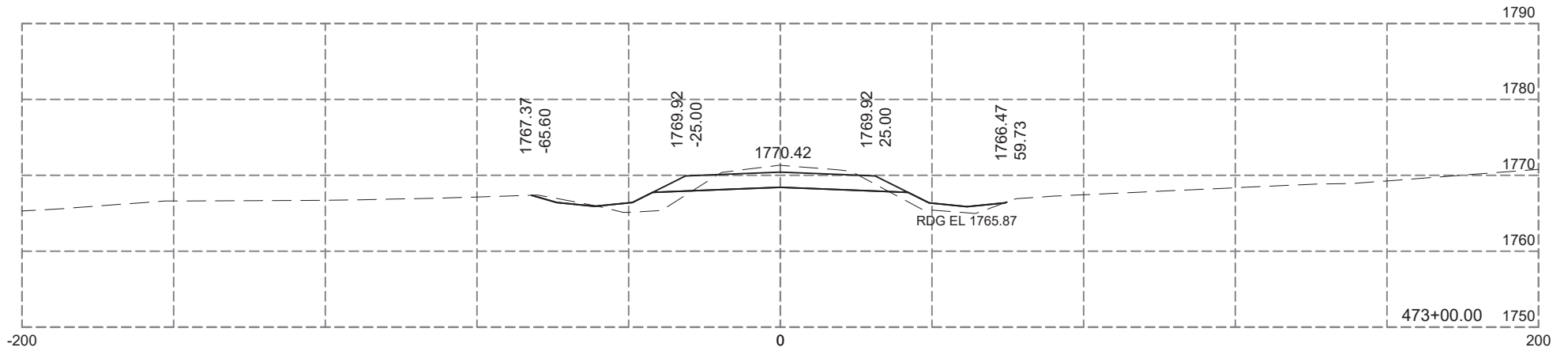
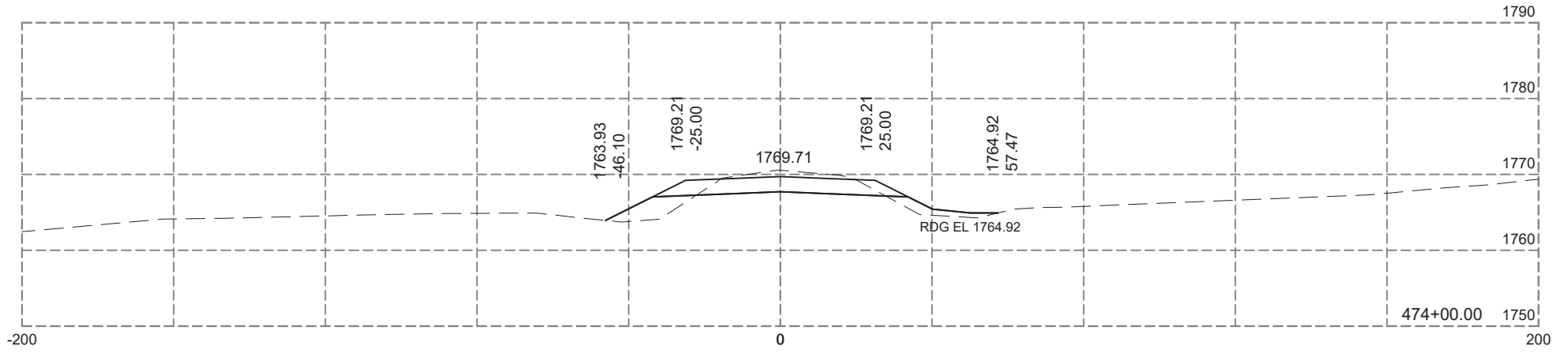

Plotting Date: 12-04-2024

STATE OF SOUTH DAKOTA	PROJECT P-PH-PT 0025(81)158	SHEET X14	TOTAL SHEETS X99
-----------------------	--------------------------------	--------------	---------------------

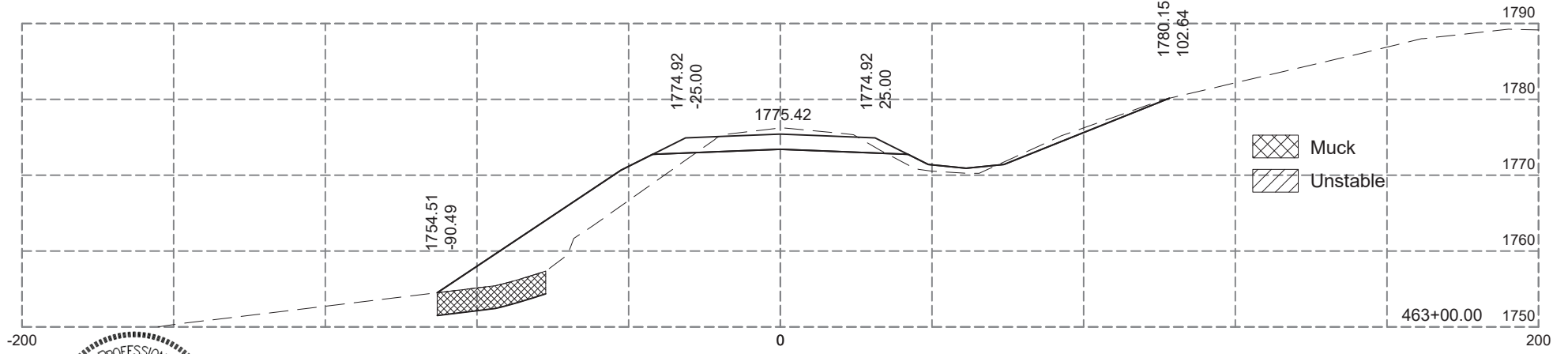
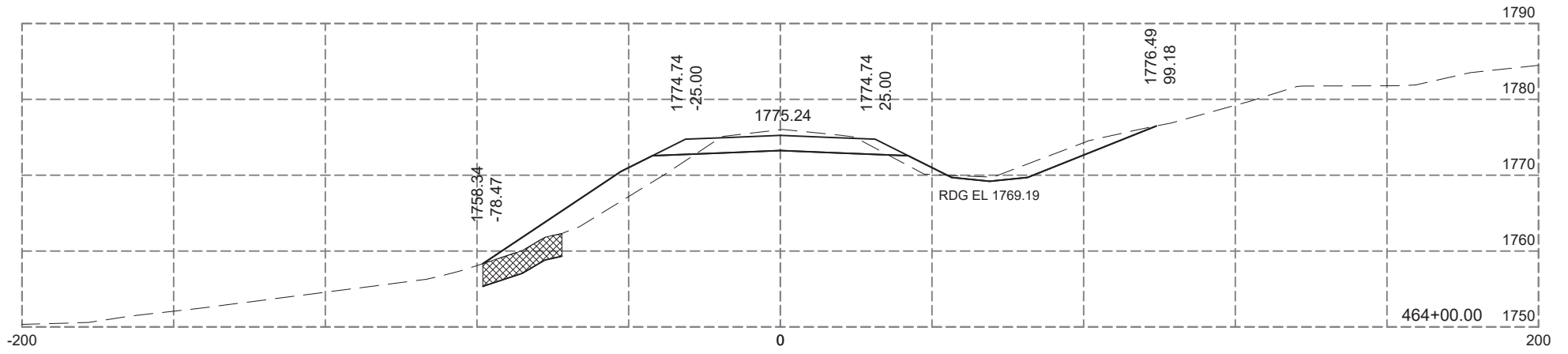
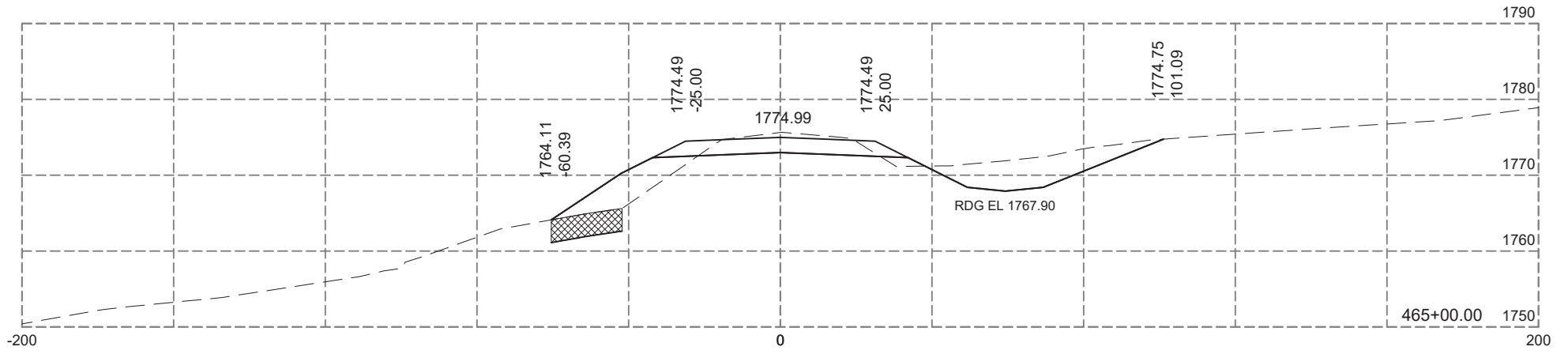
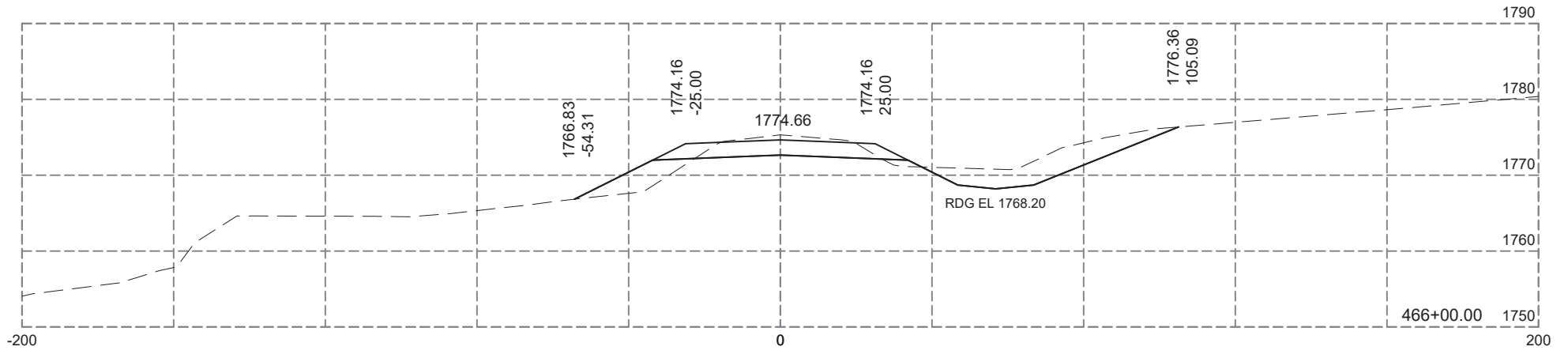
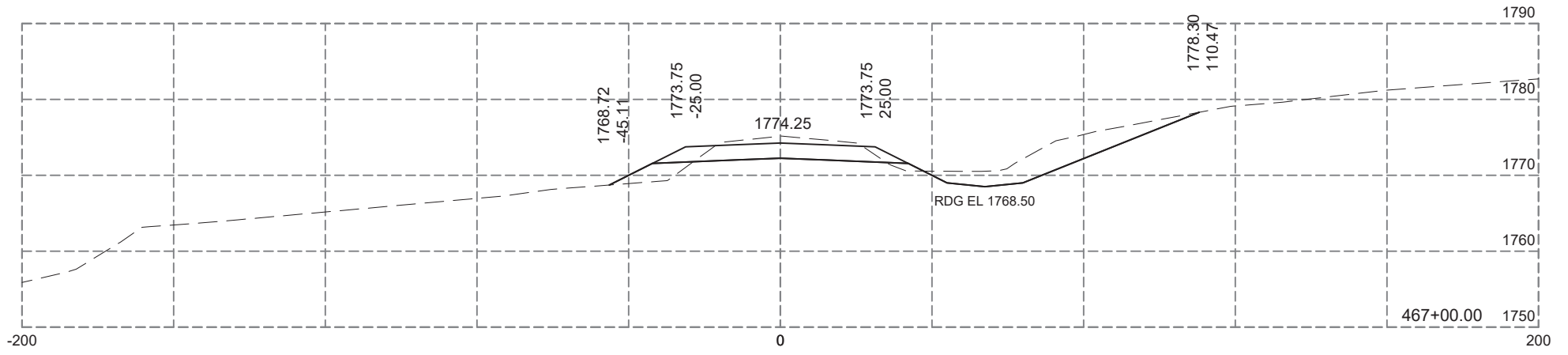
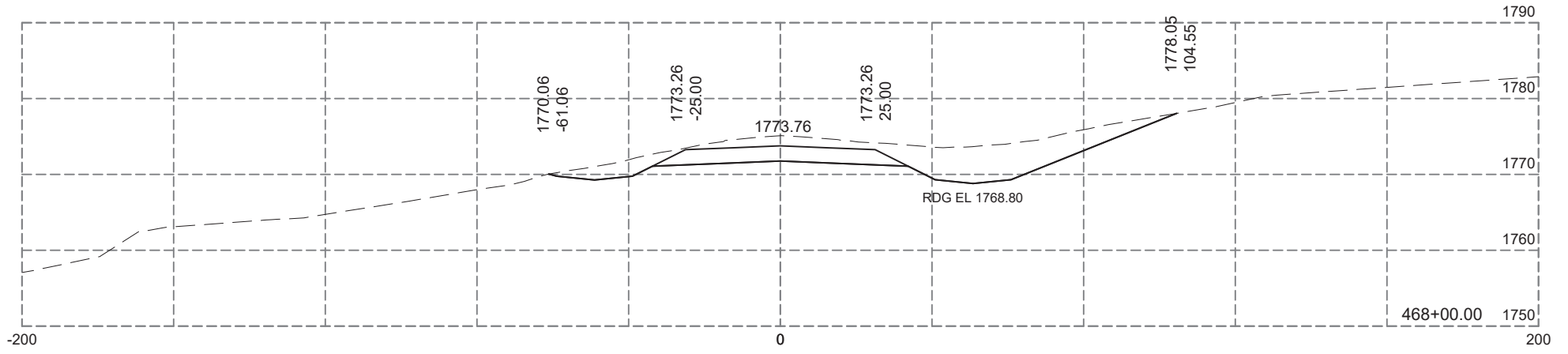

Plotting Date: 12-04-2024

STATE OF SOUTH DAKOTA	PROJECT P-PH-PT 0025(81)158	SHEET X15	TOTAL SHEETS X99
-----------------------	--------------------------------	--------------	---------------------

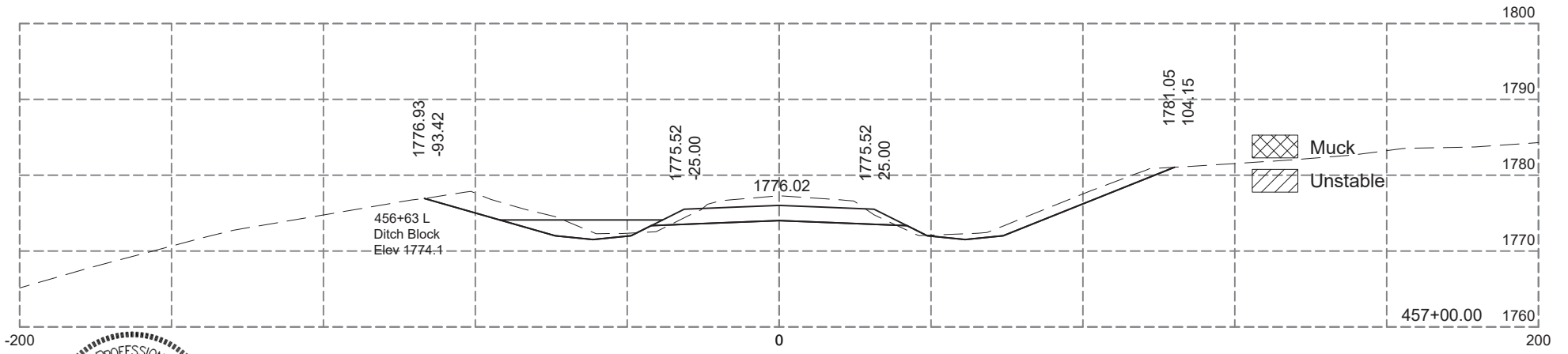
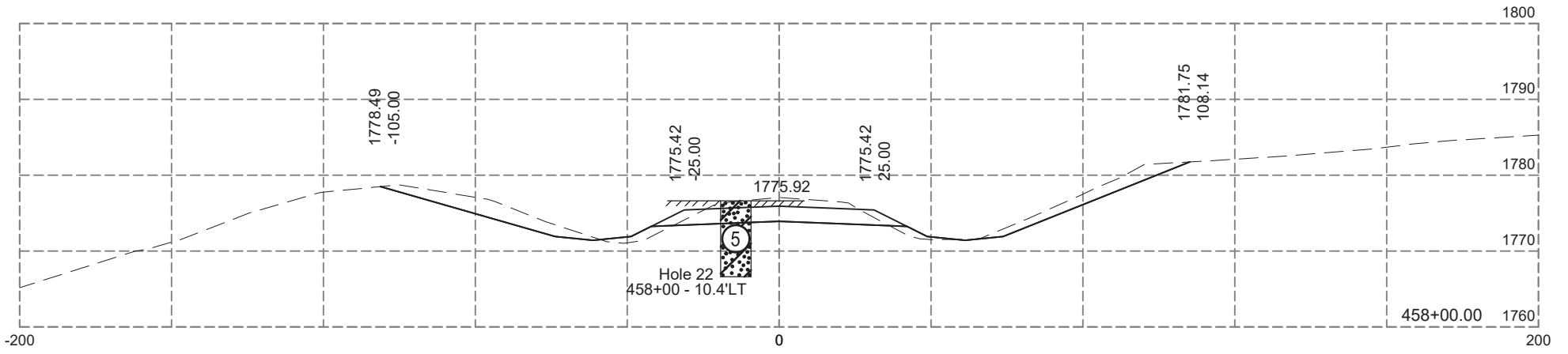
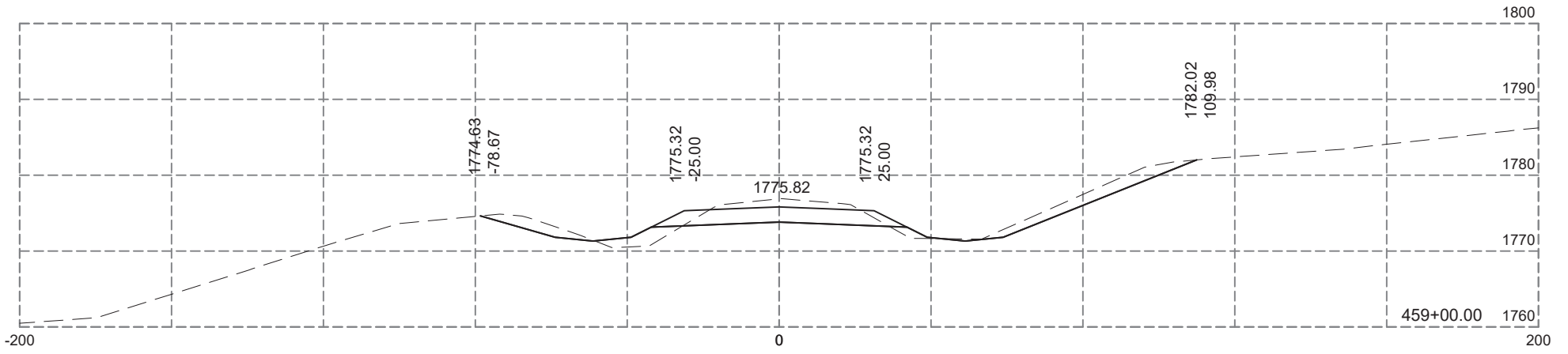
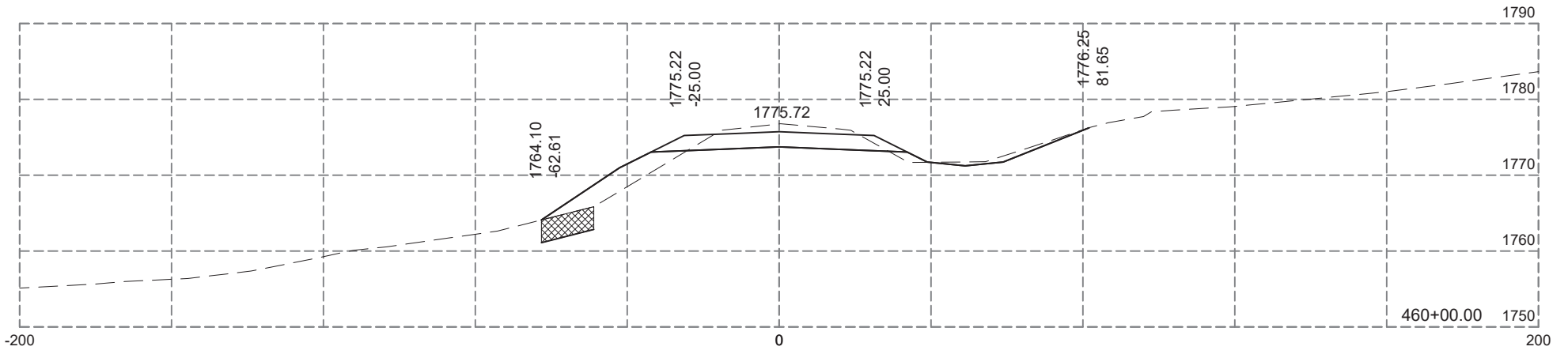
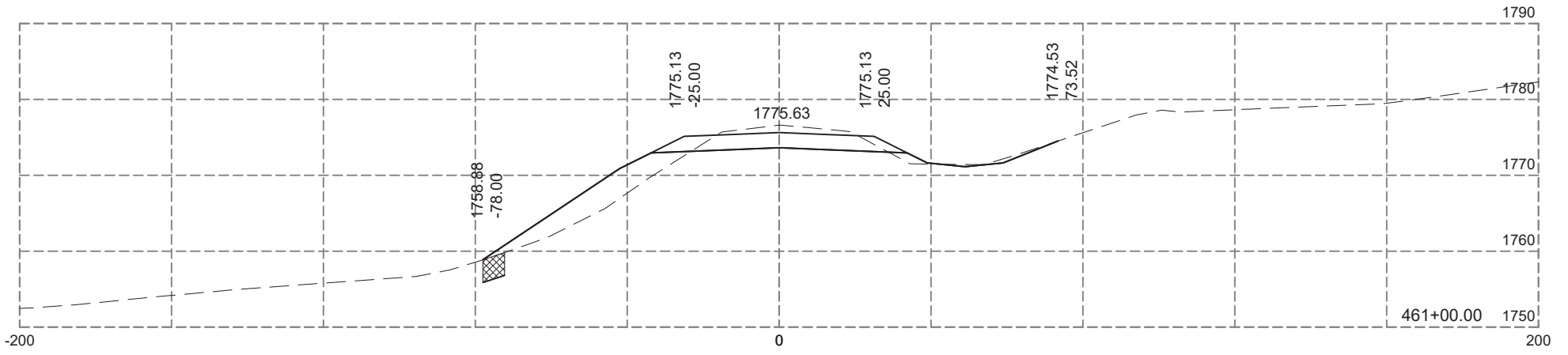
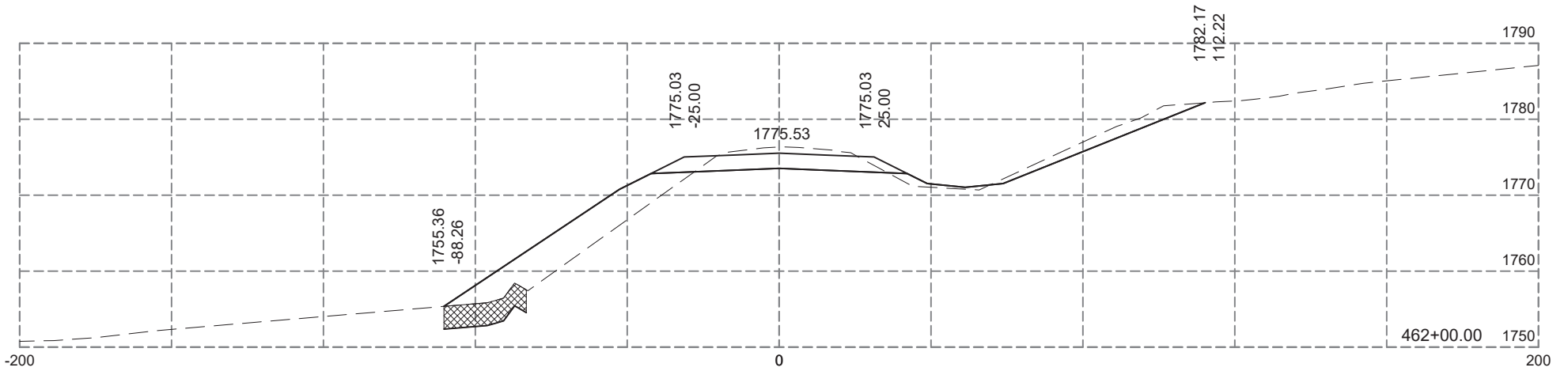

Plotting Date: 12-04-2024

STATE OF SOUTH DAKOTA	PROJECT P-PH-PT 0025(81)158	SHEET X16	TOTAL SHEETS X99
-----------------------	--------------------------------	--------------	---------------------



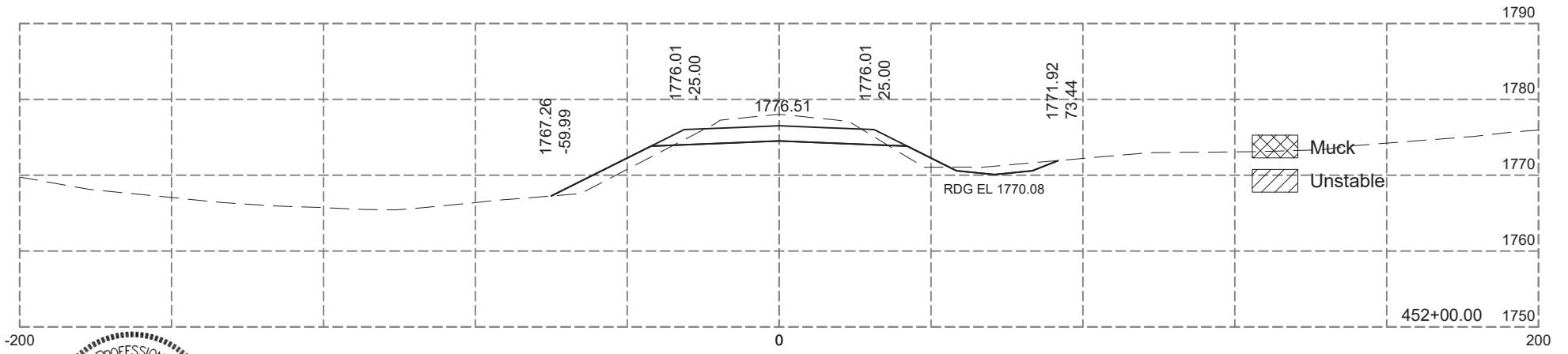
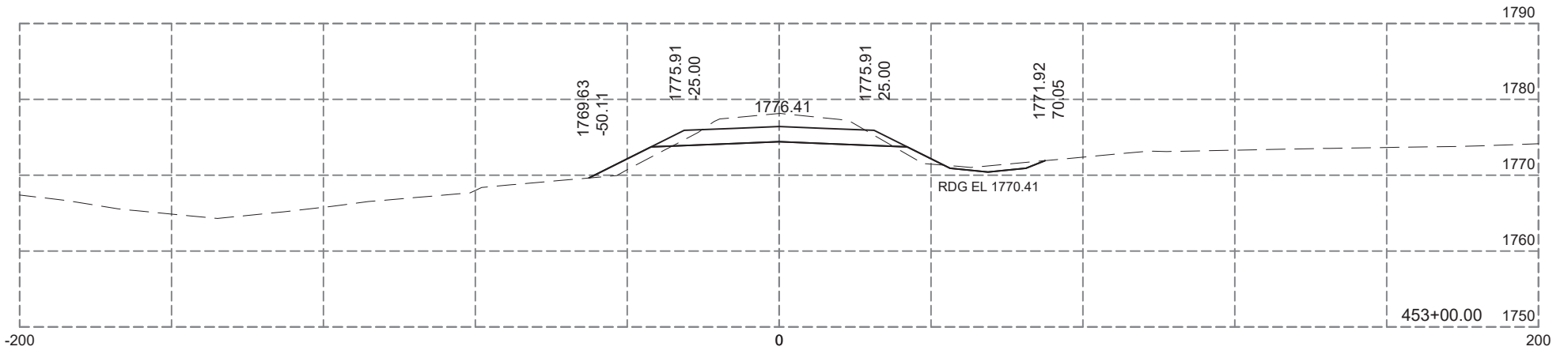
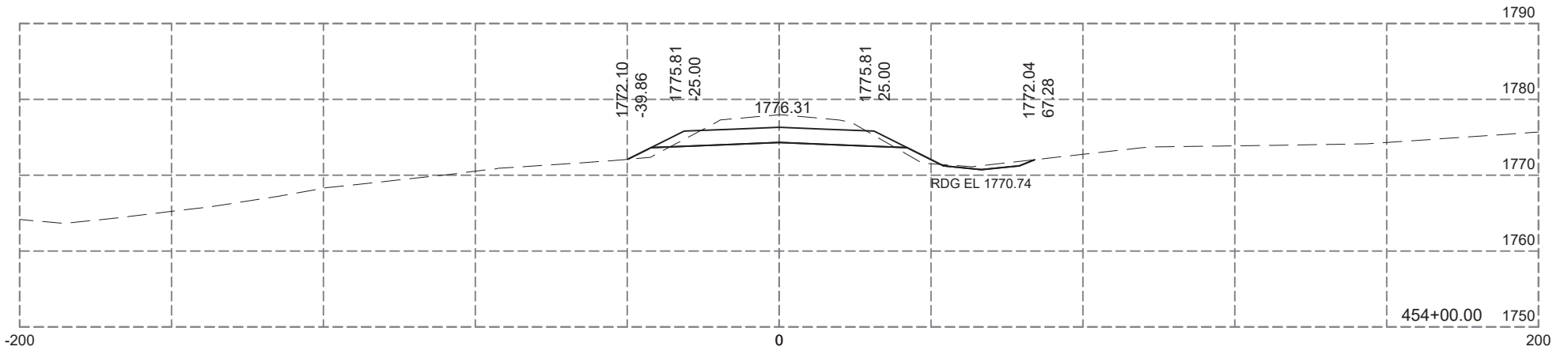
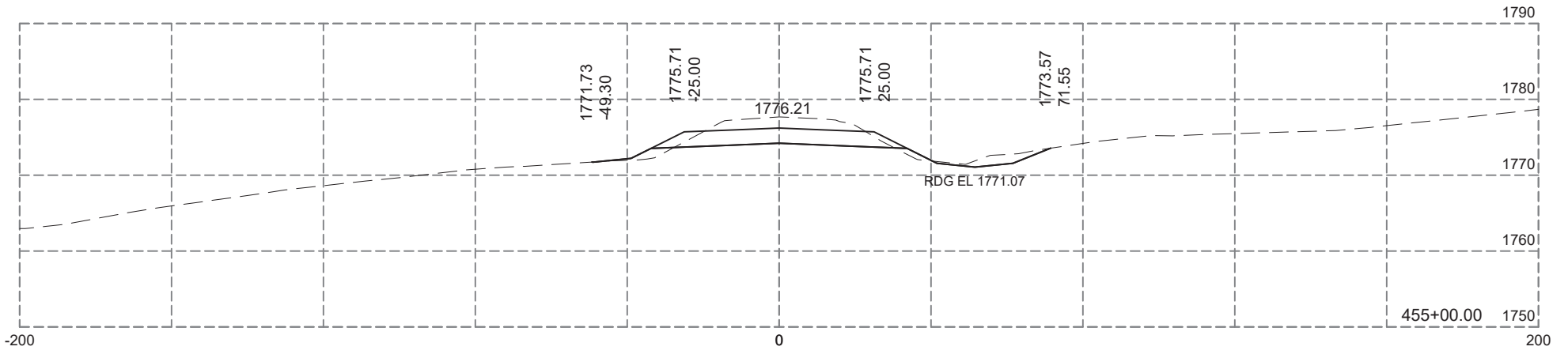
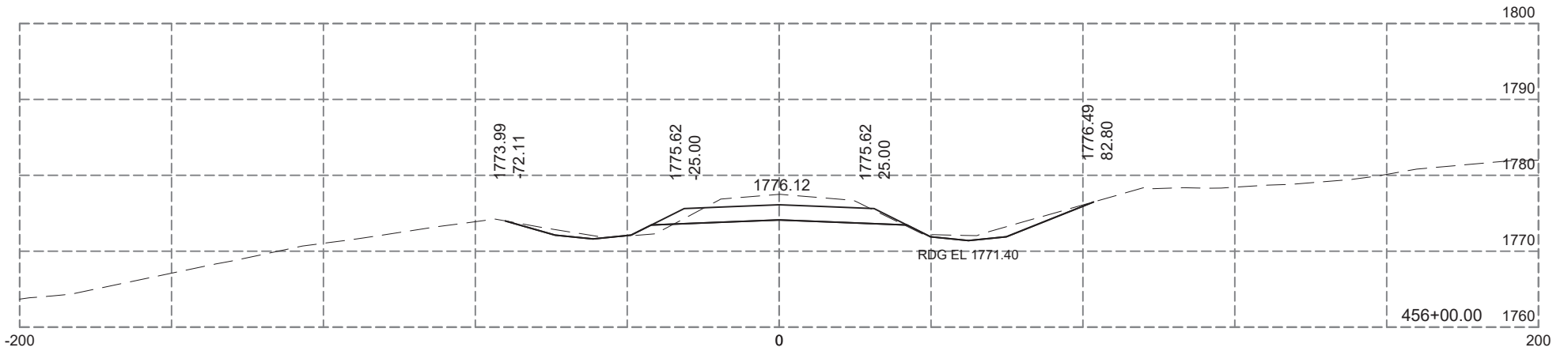
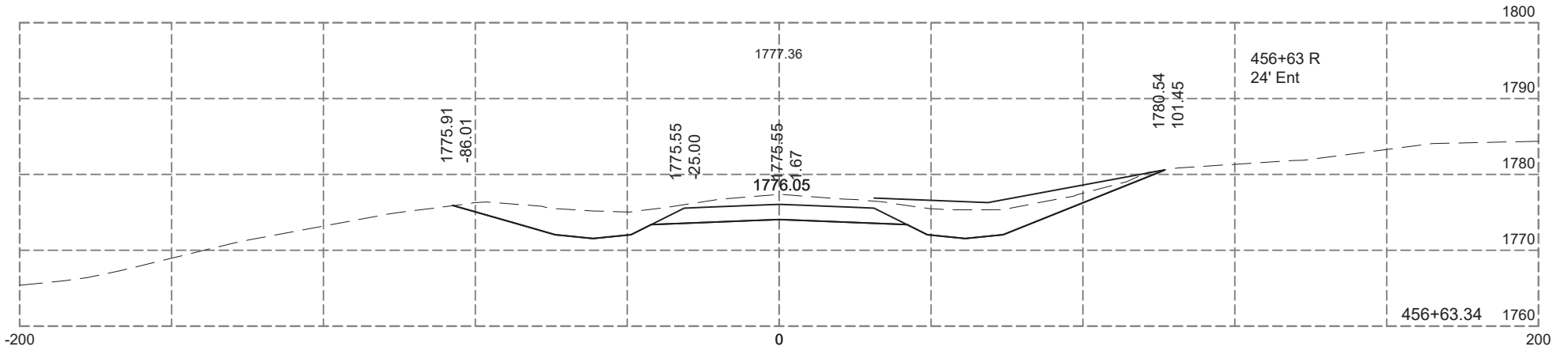

Plotting Date: 12-04-2024

STATE OF SOUTH DAKOTA	PROJECT P-PH-PT 0025(81)158	SHEET X17	TOTAL SHEETS X99
-----------------------	--------------------------------	--------------	---------------------

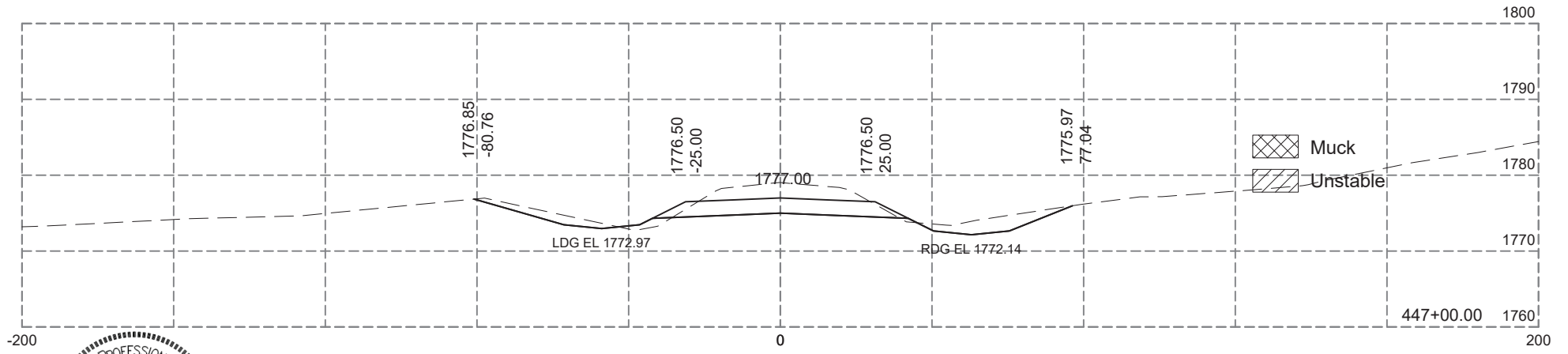
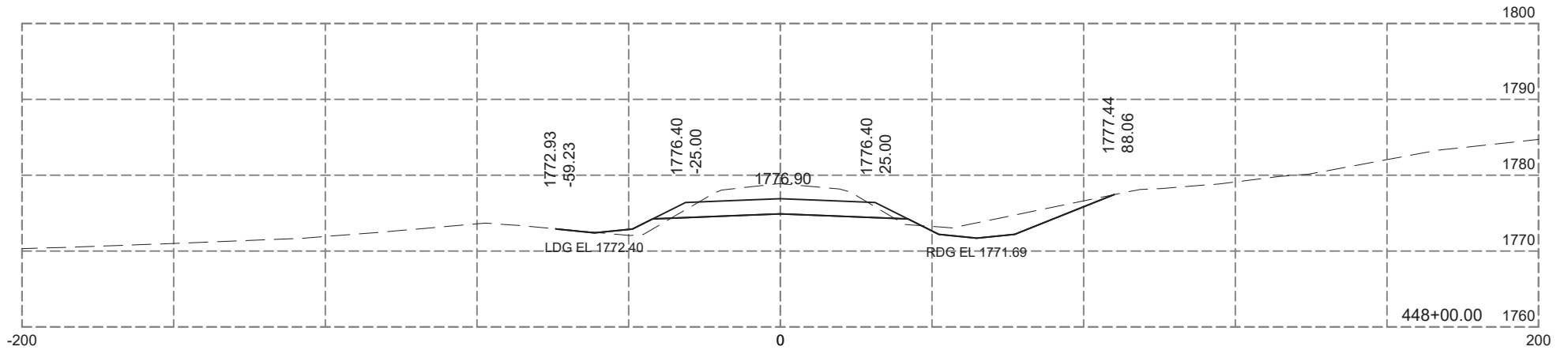
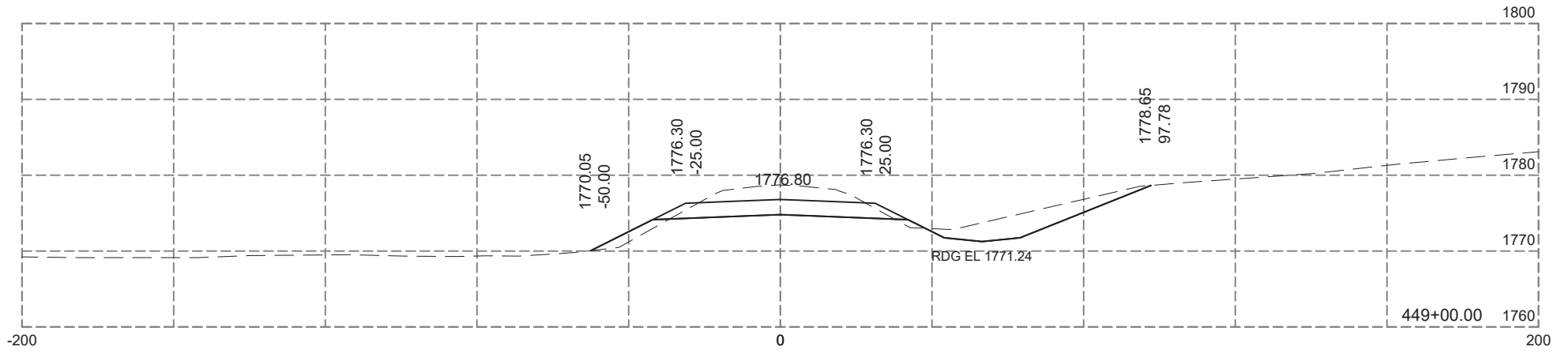
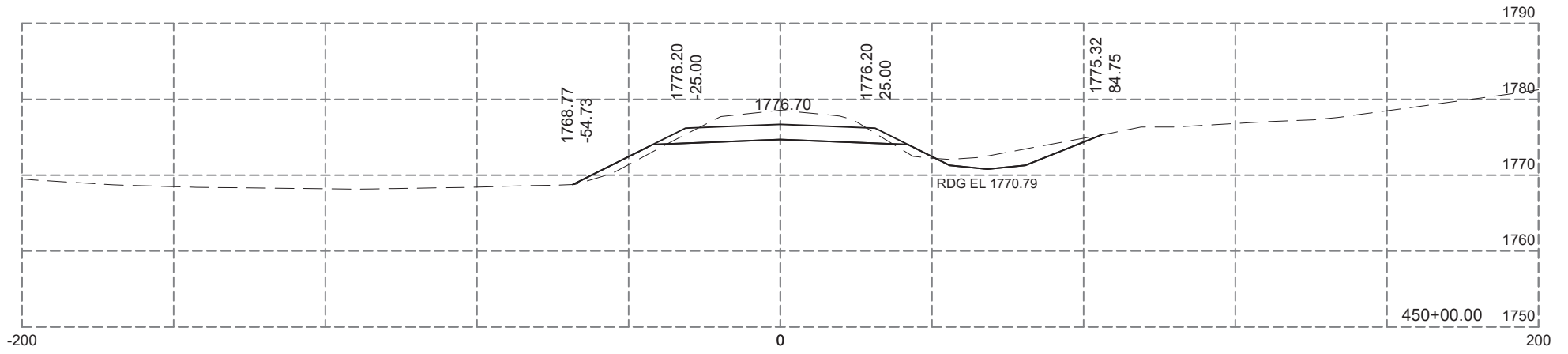
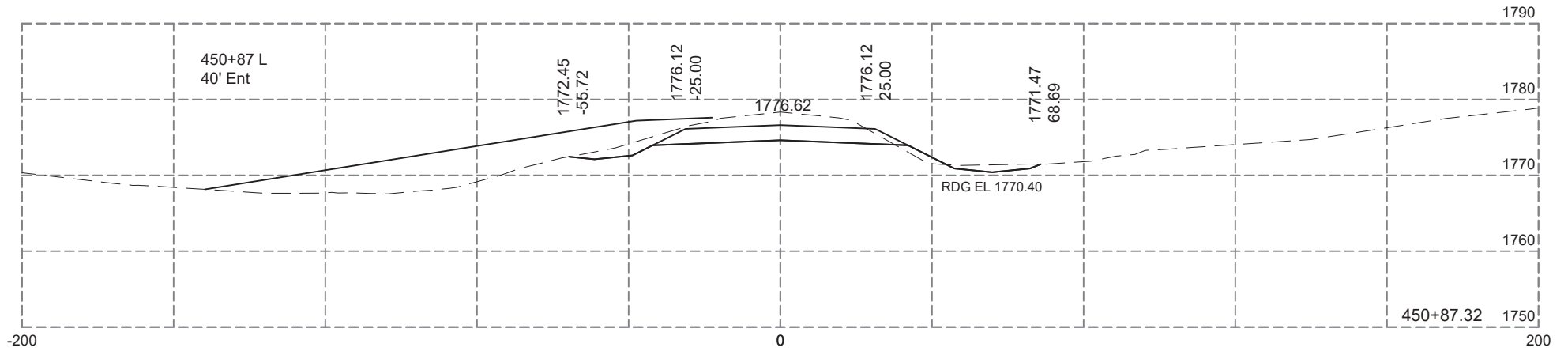
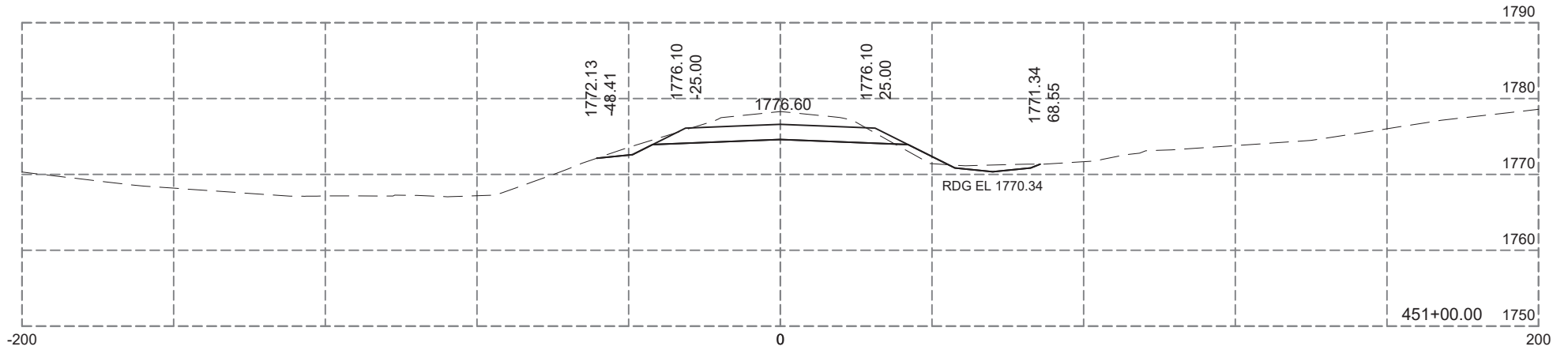

Muck  
 Unstable



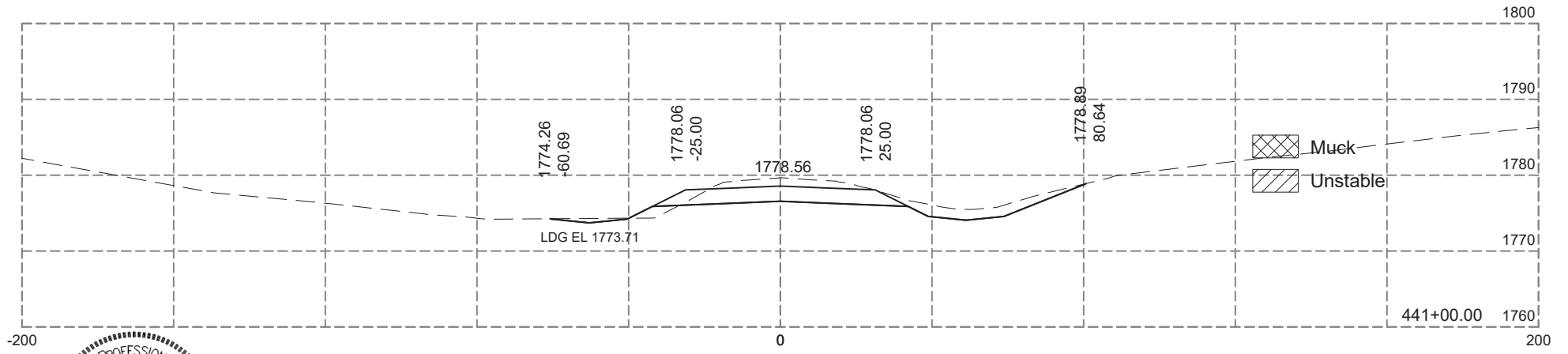
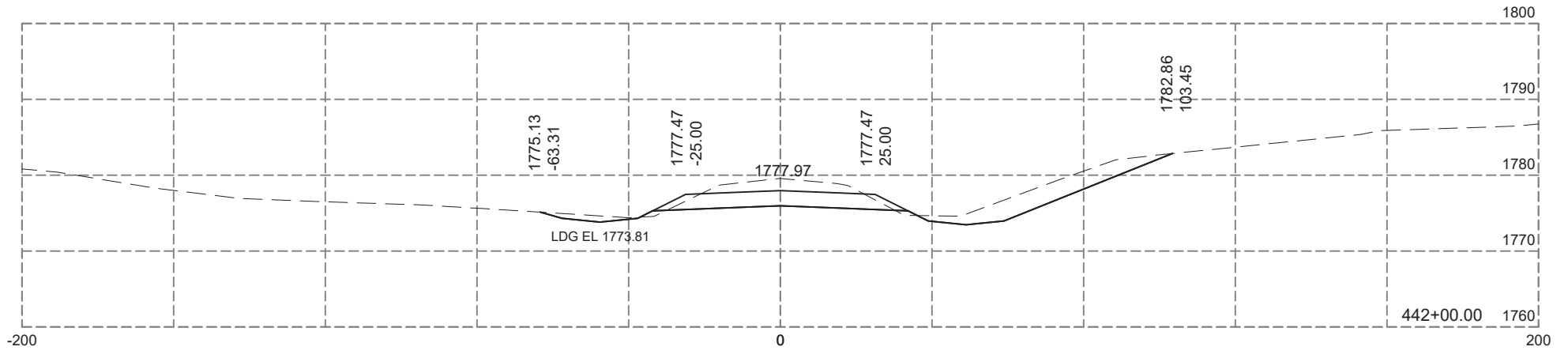
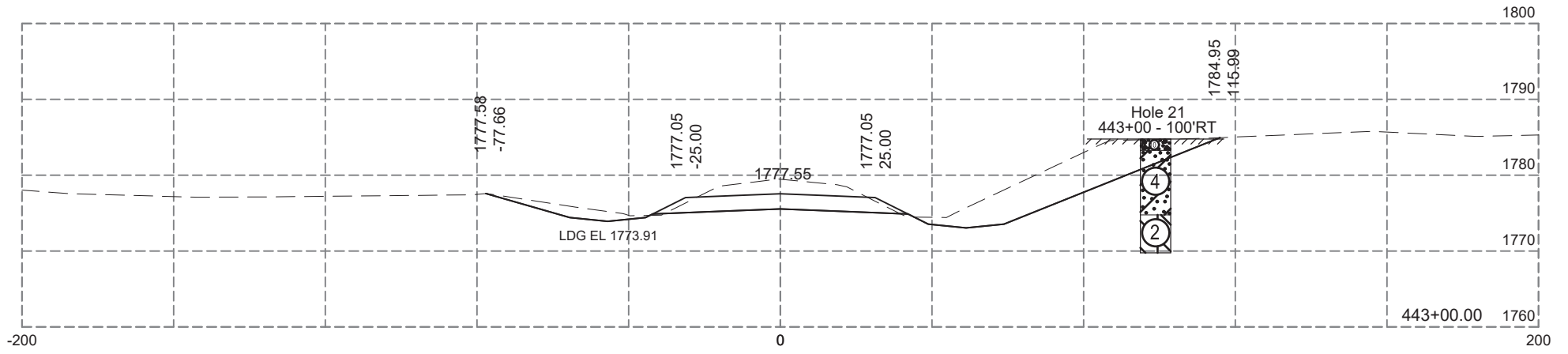
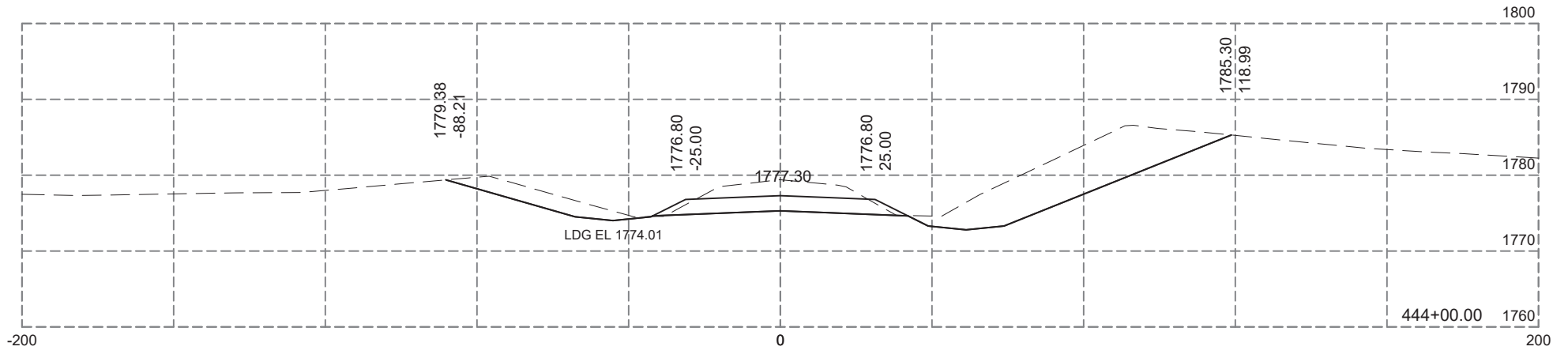
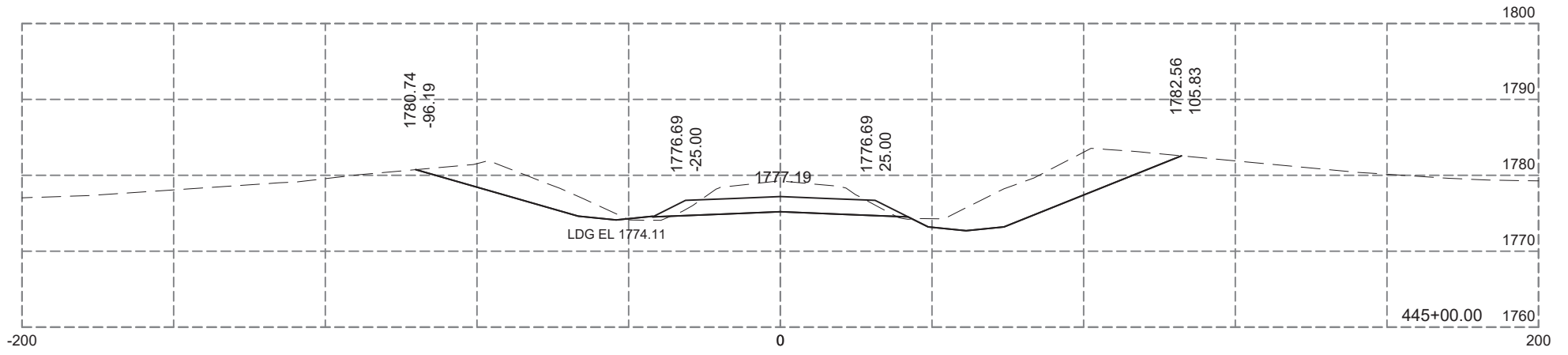
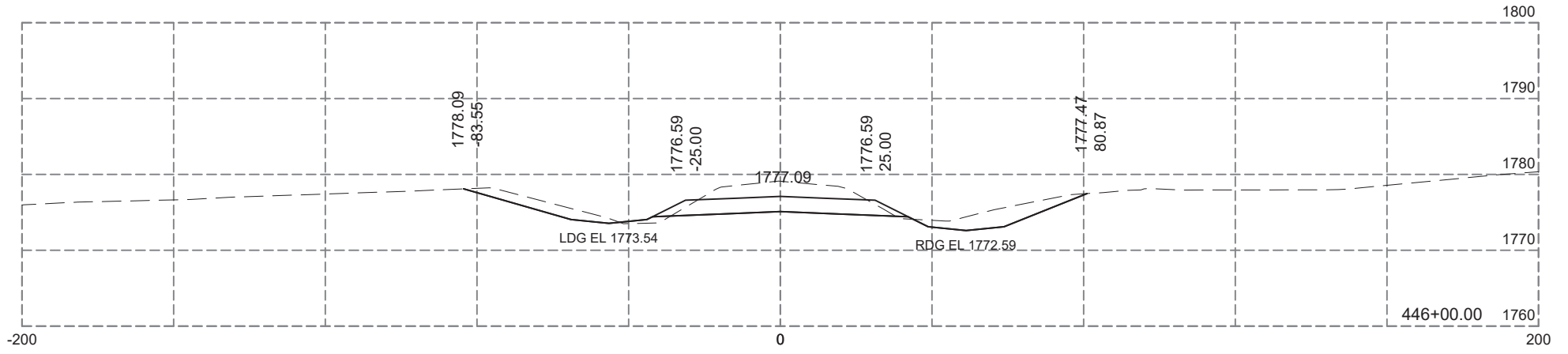

Plotting Date: 12-04-2024

STATE OF SOUTH DAKOTA	PROJECT P-PH-PT 0025(81)158	SHEET X19	TOTAL SHEETS X99
-----------------------	--------------------------------	--------------	---------------------

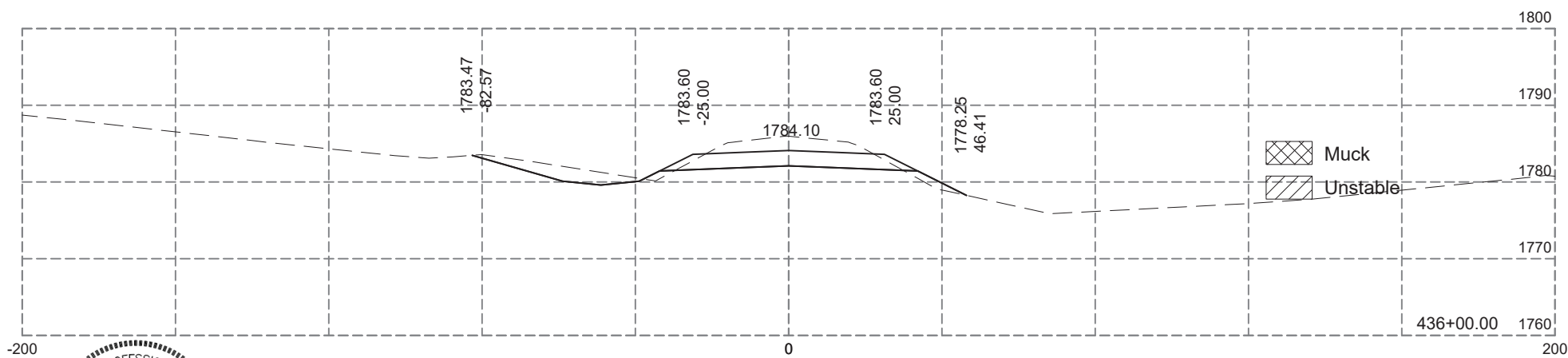
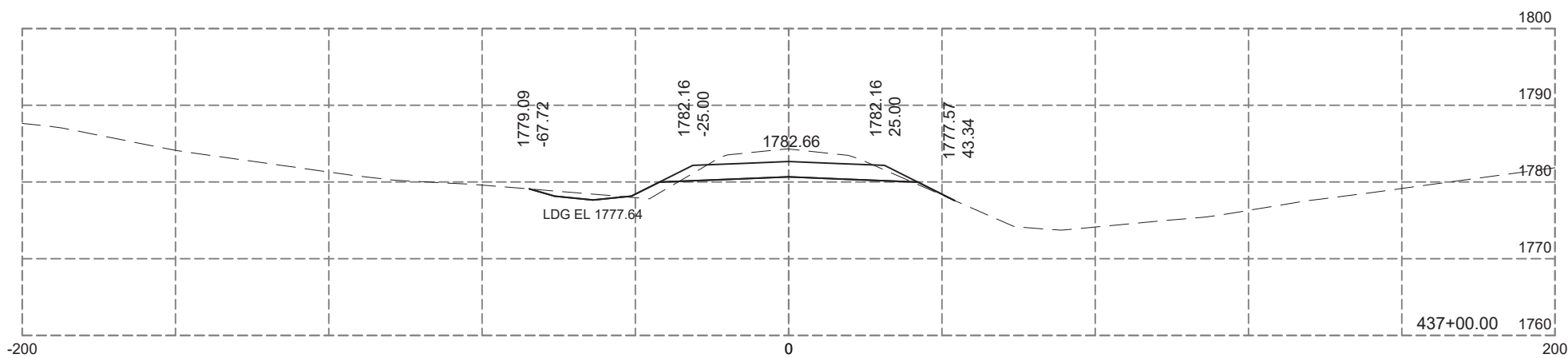
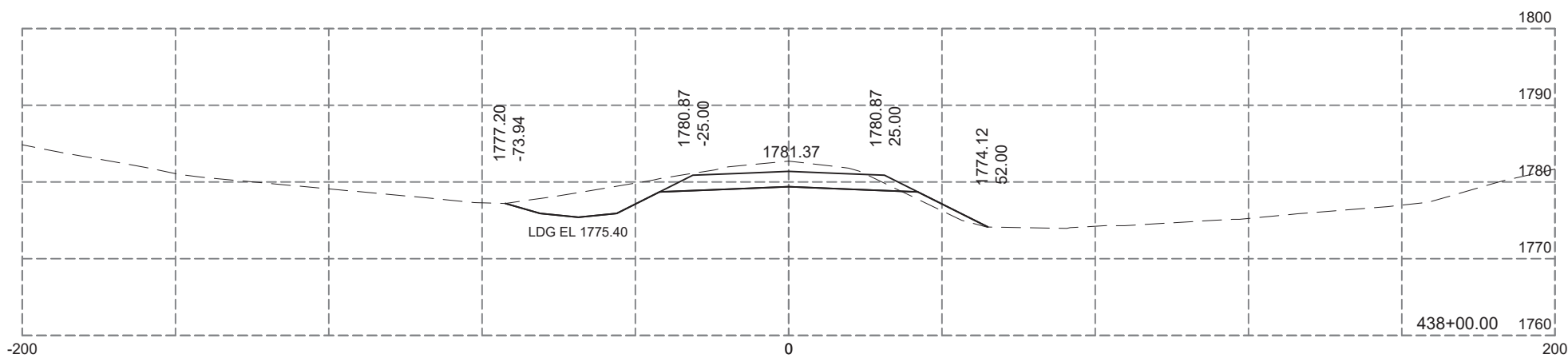
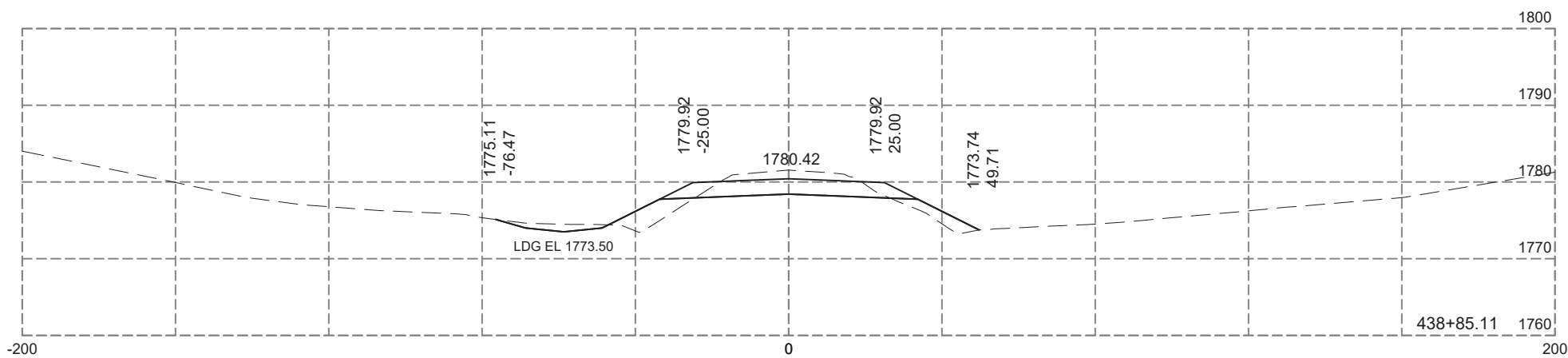
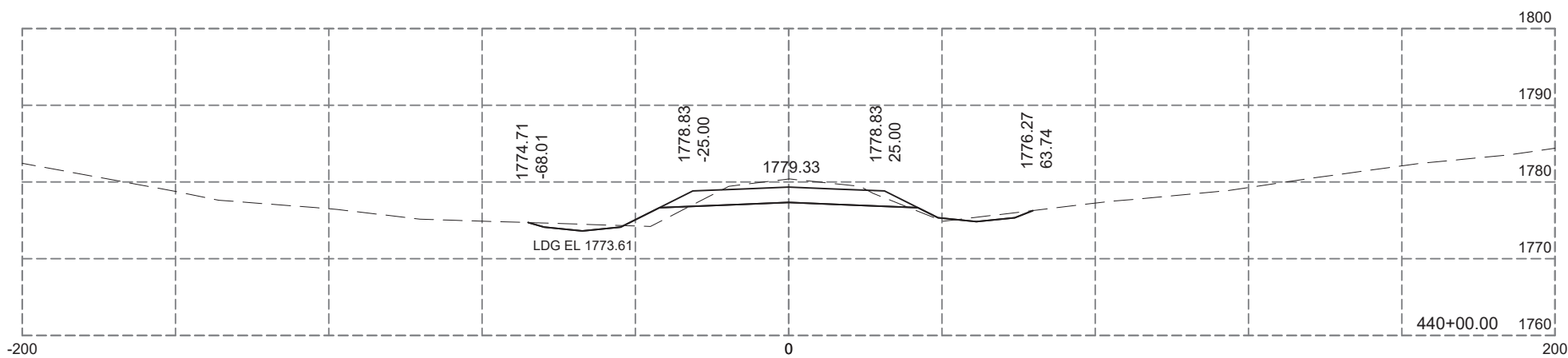
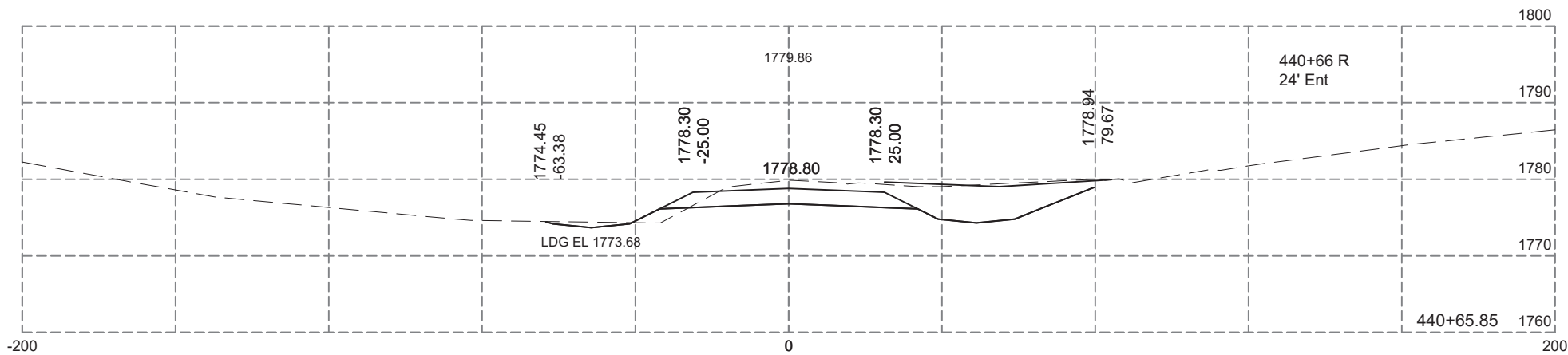

Plotting Date: 12-04-2024

STATE OF SOUTH DAKOTA	PROJECT P-PH-PT 0025(81)158	SHEET X20	TOTAL SHEETS X99
-----------------------	--------------------------------	--------------	---------------------

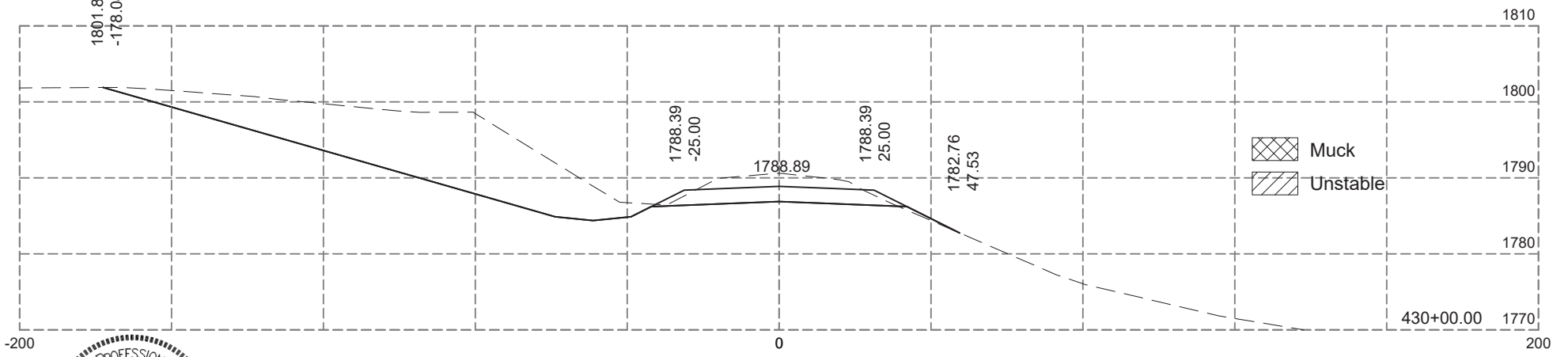
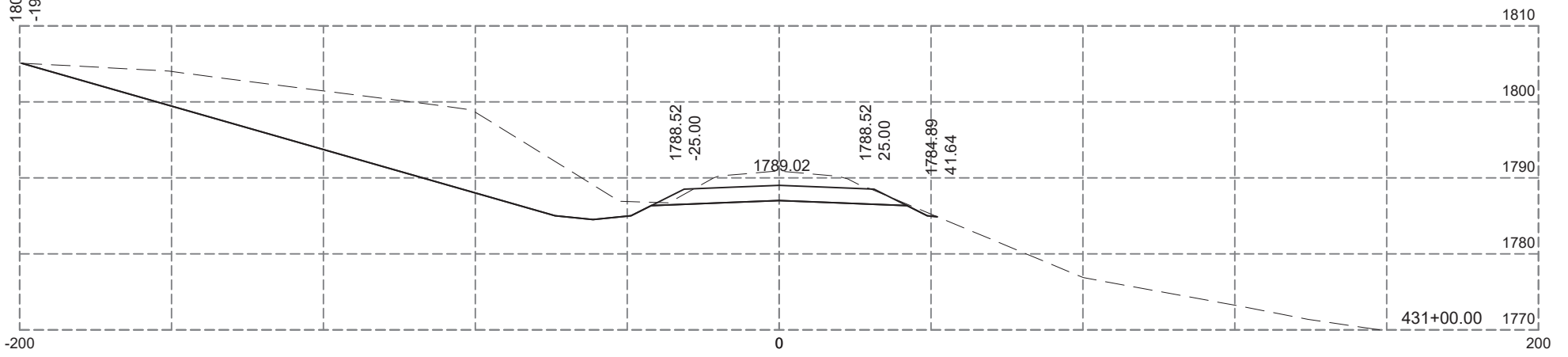
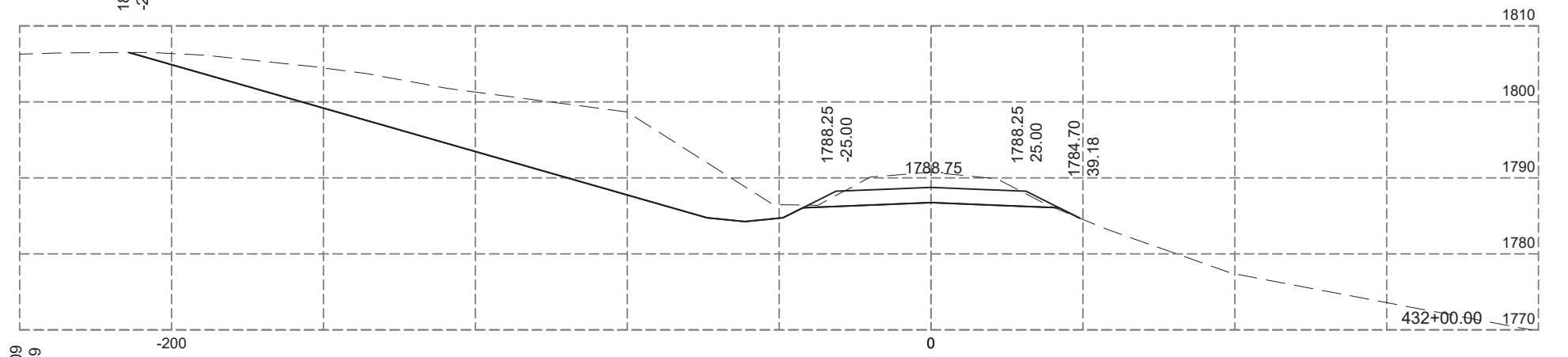
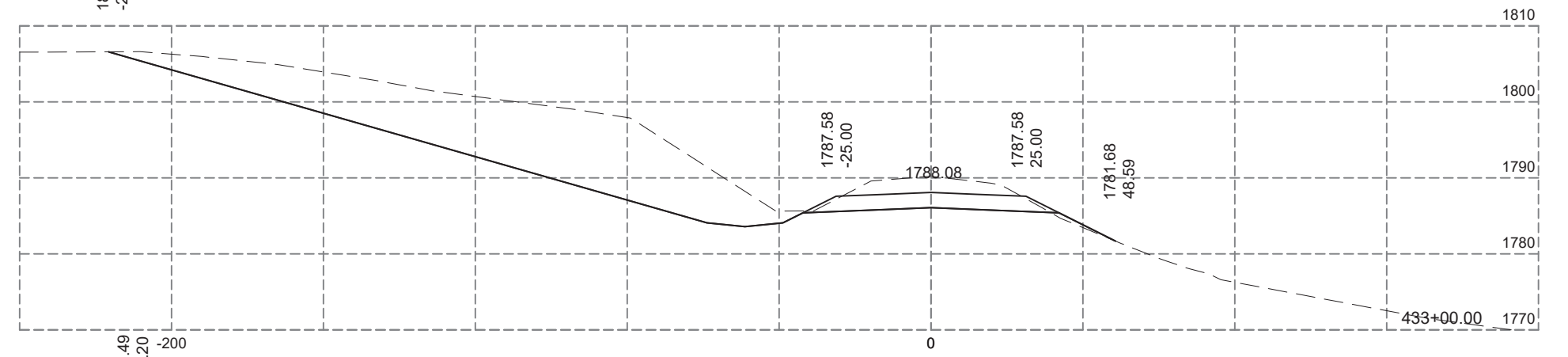
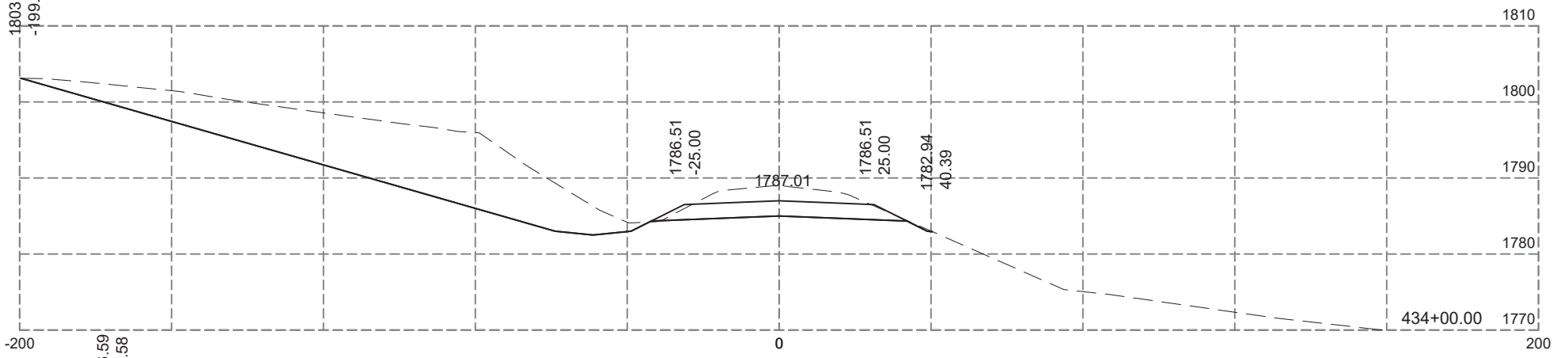
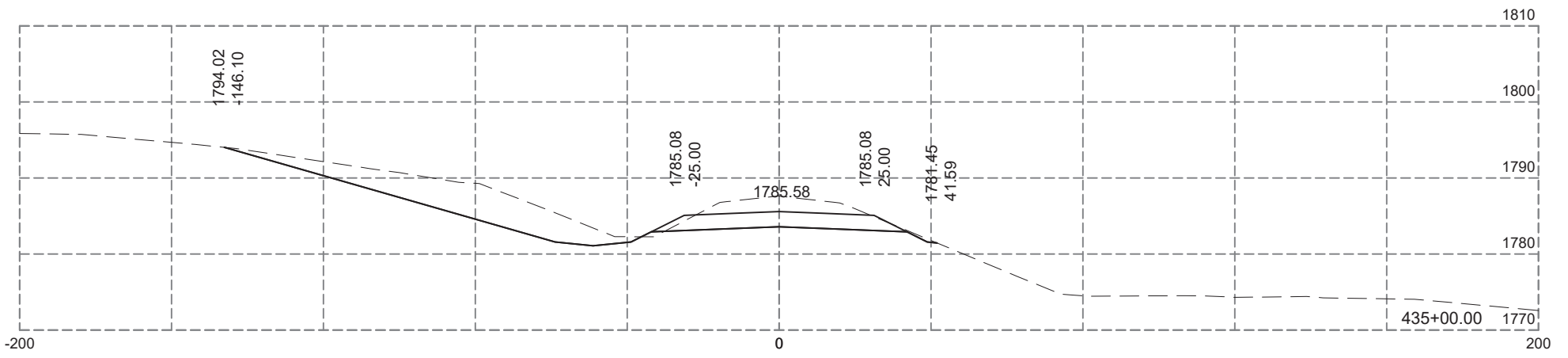

Plotting Date: 12-04-2024

STATE OF SOUTH DAKOTA	PROJECT P-PH-PT 0025(81)158	SHEET X21	TOTAL SHEETS X99
-----------------------	--------------------------------	--------------	---------------------

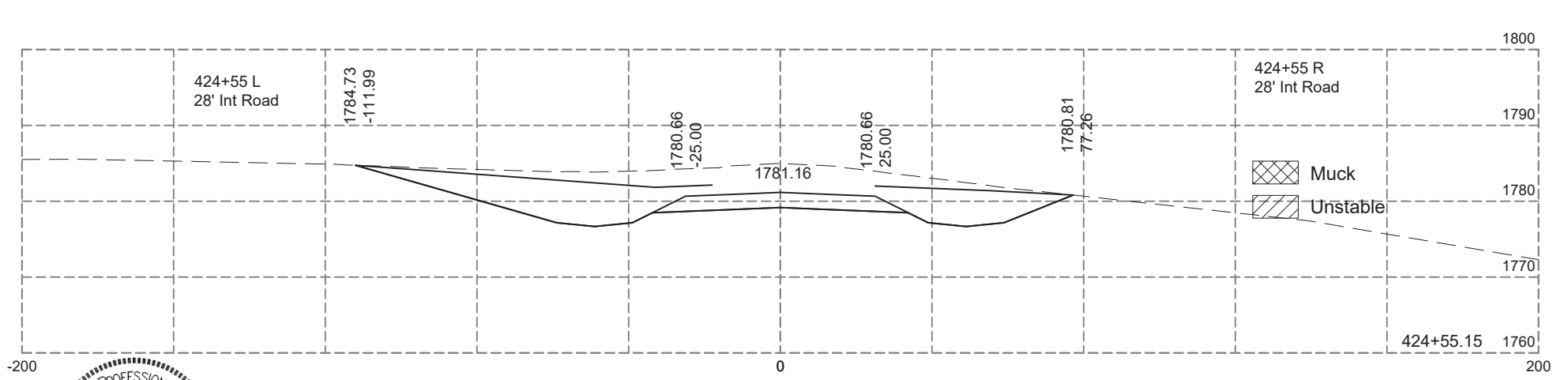
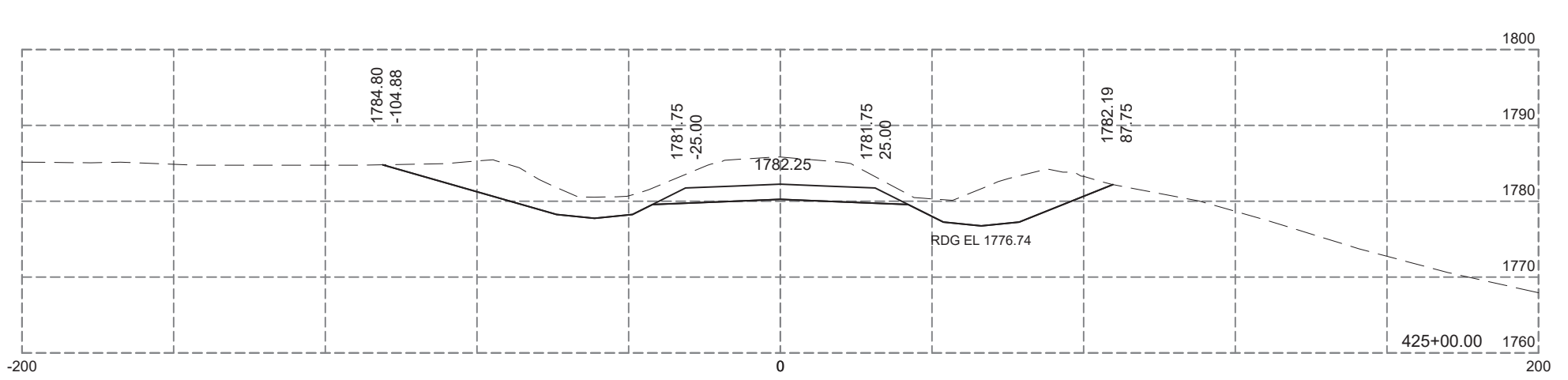
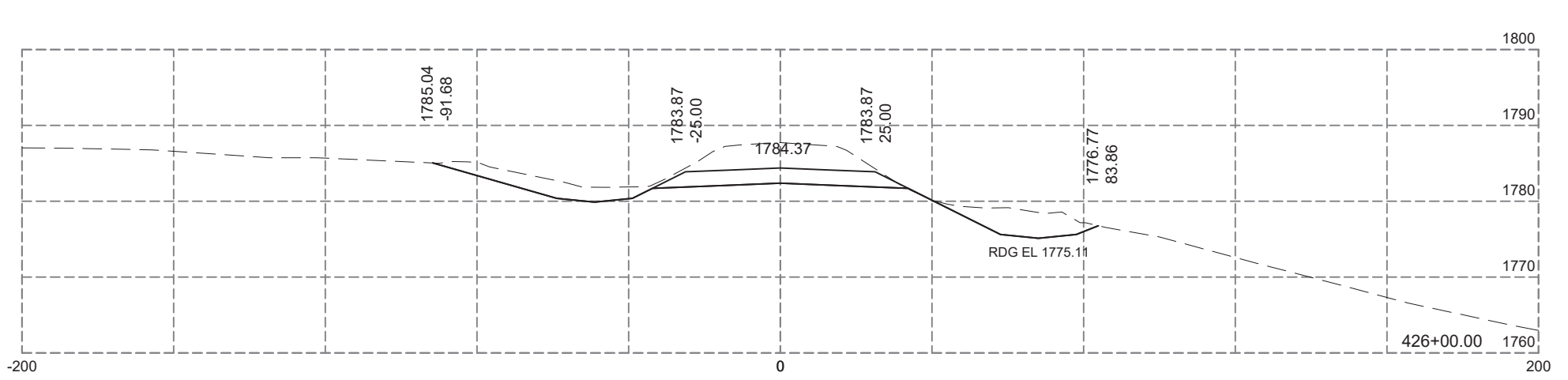
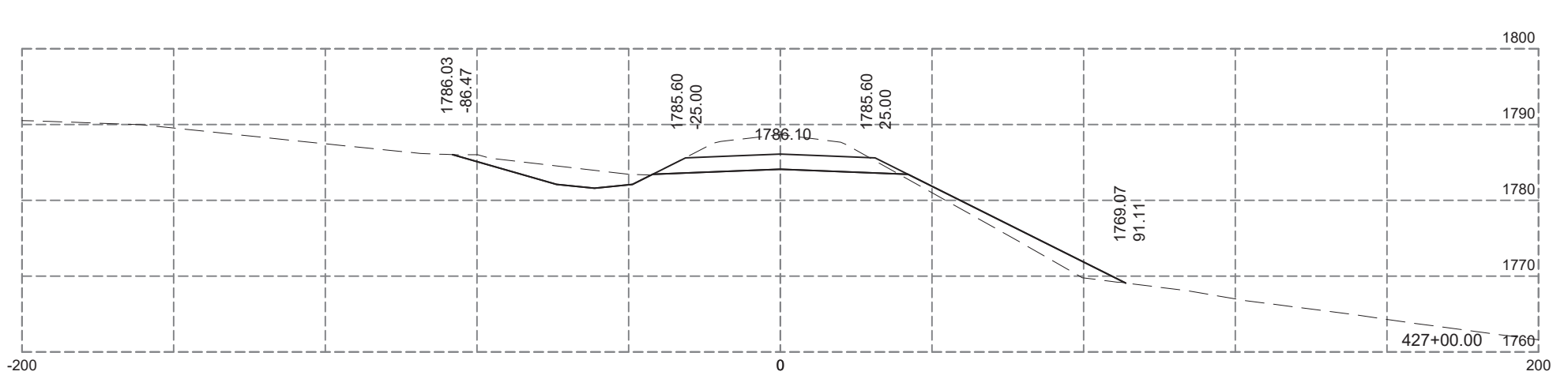
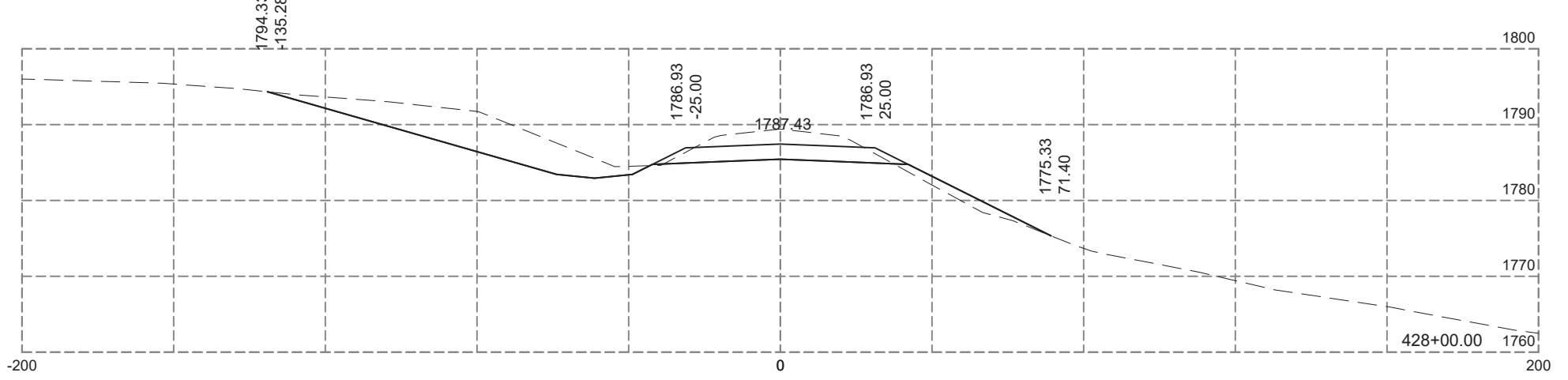
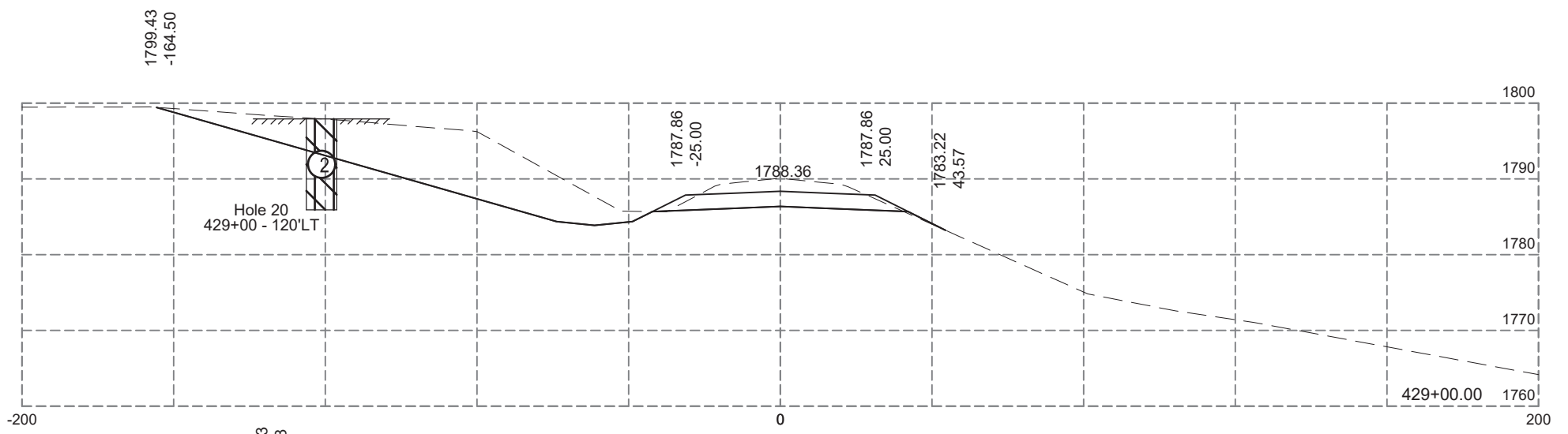

Muck  
 Unstable



Plotting Date: 12-04-2024

STATE OF SOUTH DAKOTA	PROJECT P-PH-PT 0025(81)158	SHEET X22	TOTAL SHEETS X99
-----------------------	--------------------------------	--------------	---------------------

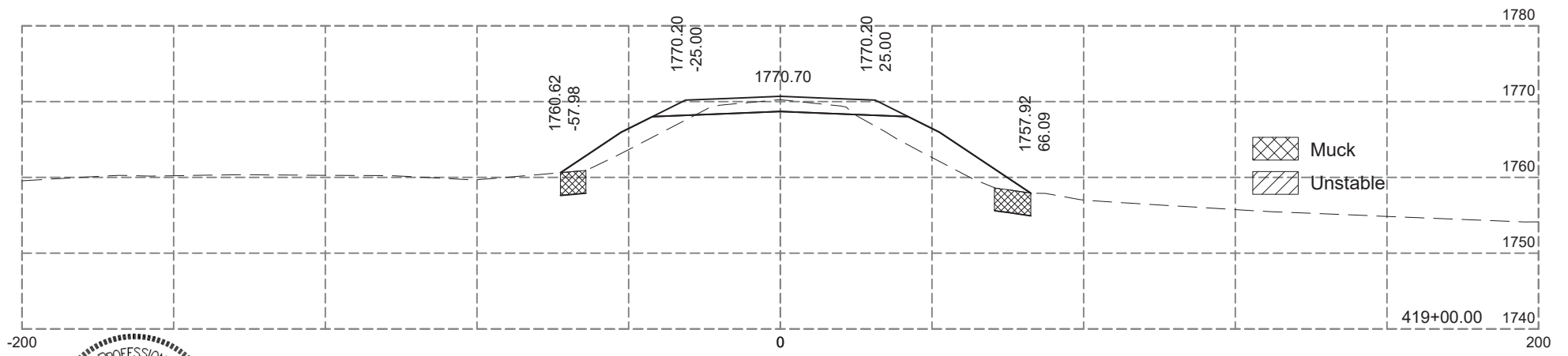
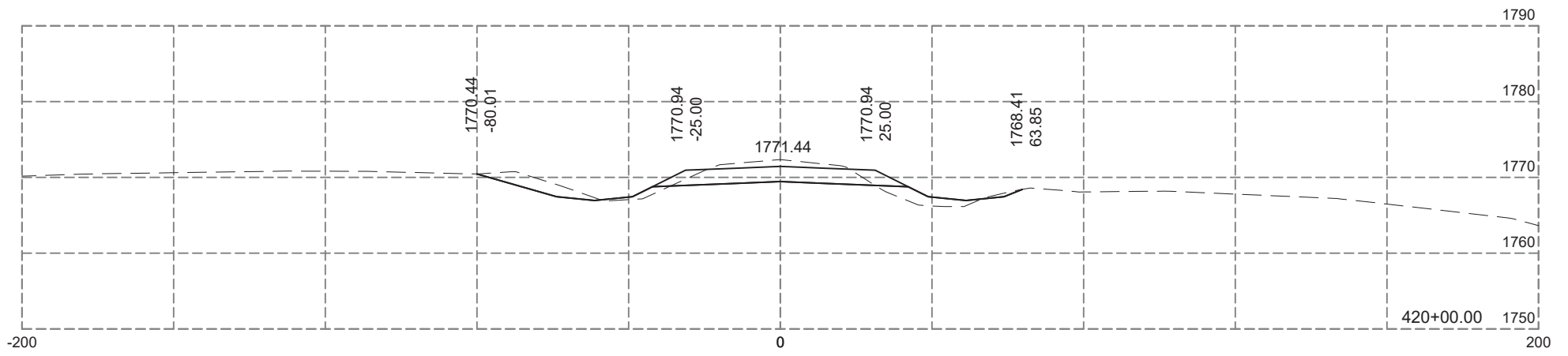
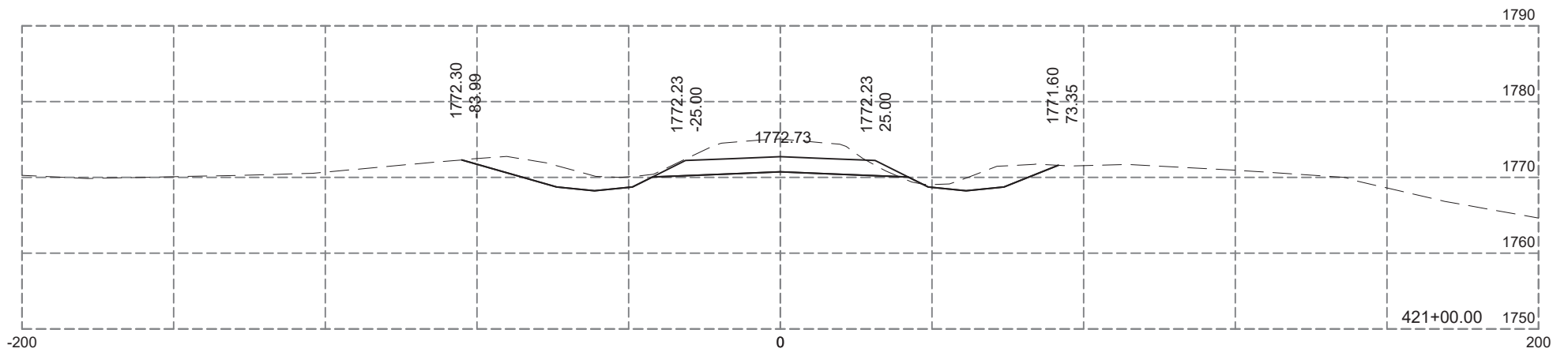
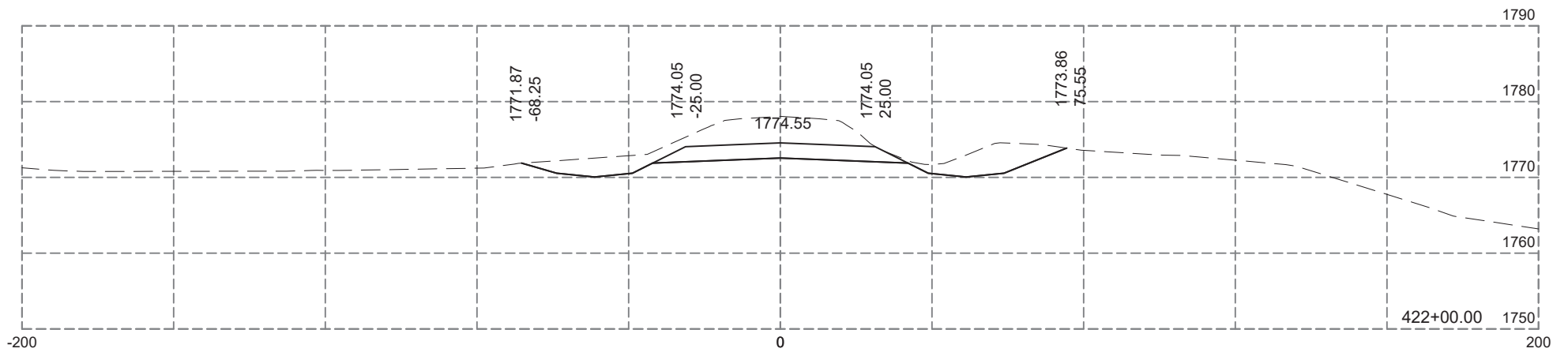
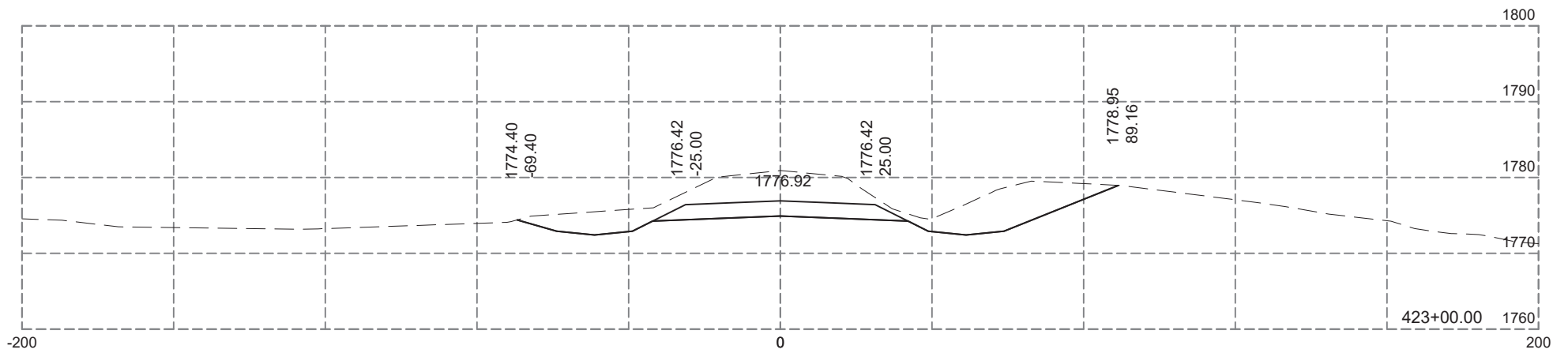
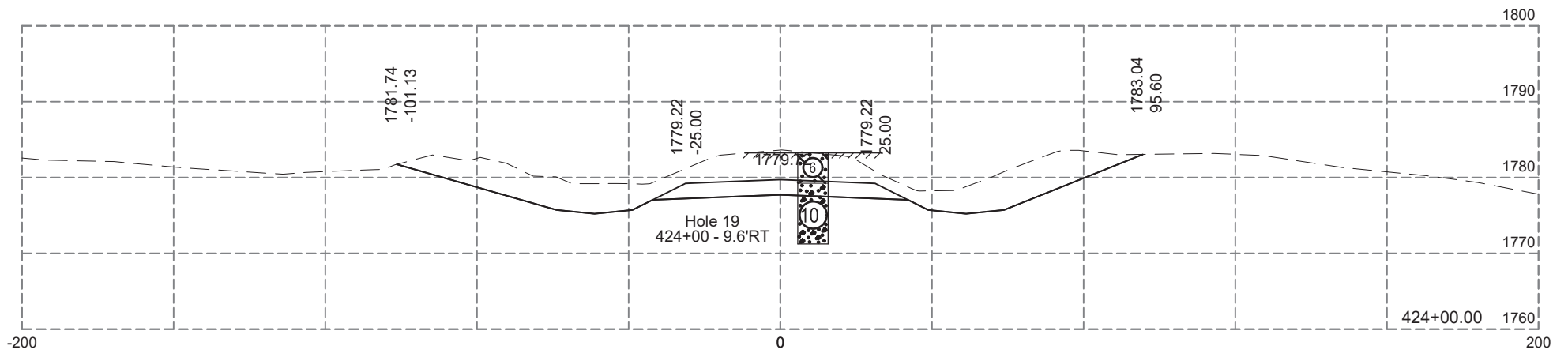

Plotting Date: 12-04-2024

STATE OF SOUTH DAKOTA	PROJECT P-PH-PT 0025(81)158	SHEET X23	TOTAL SHEETS X99
-----------------------	--------------------------------	--------------	---------------------

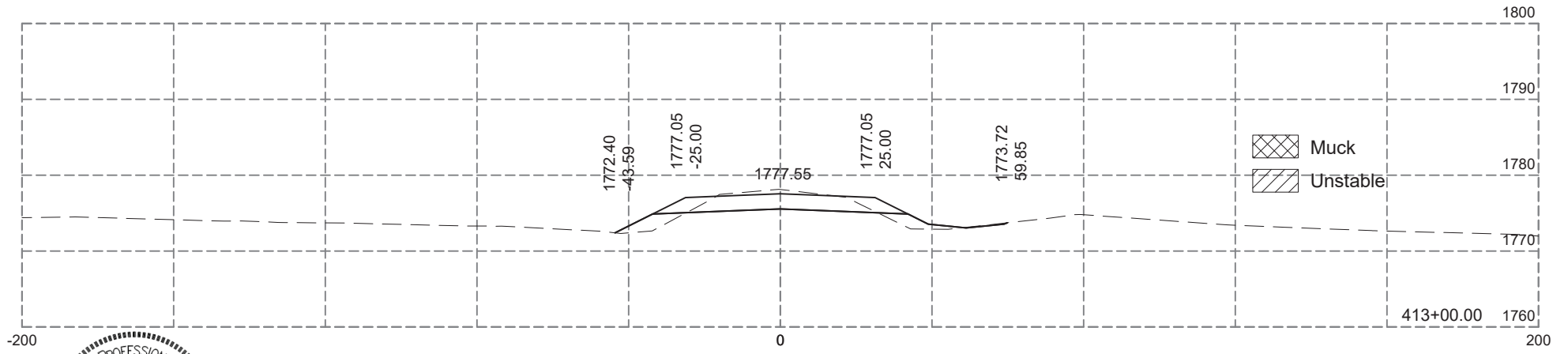
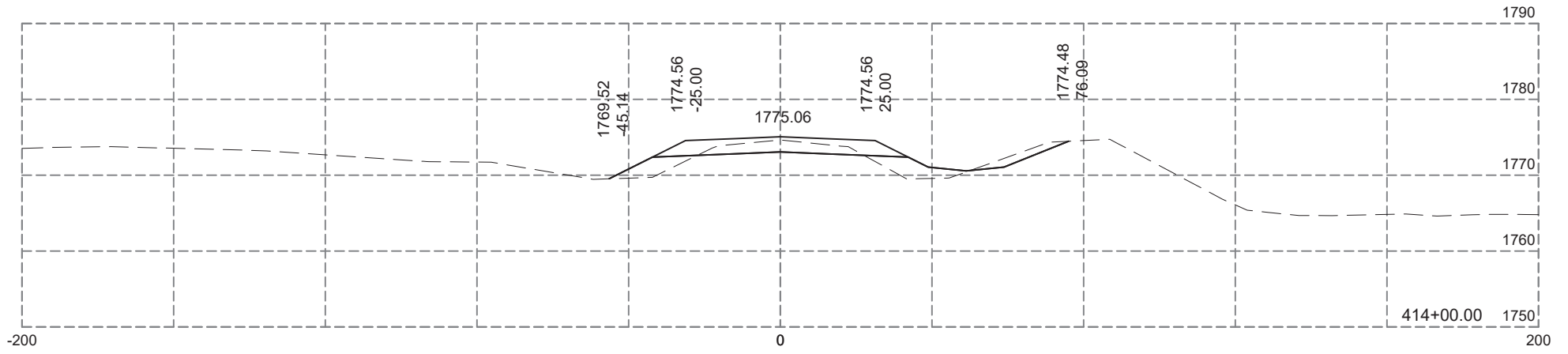
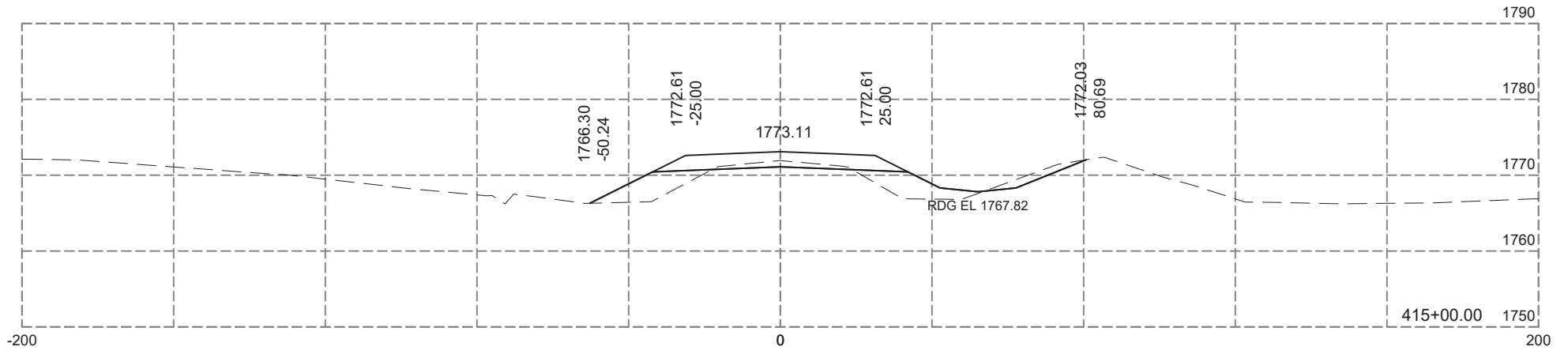
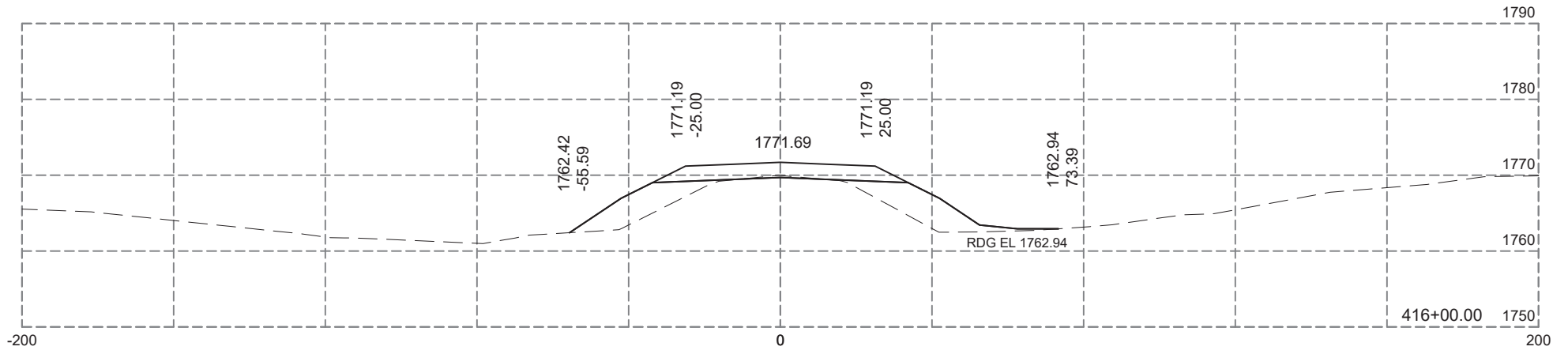
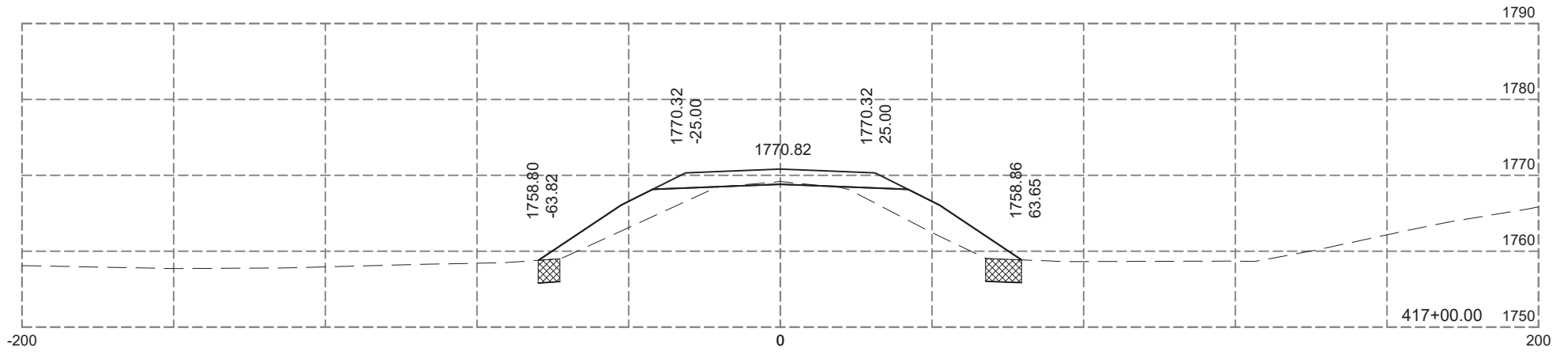
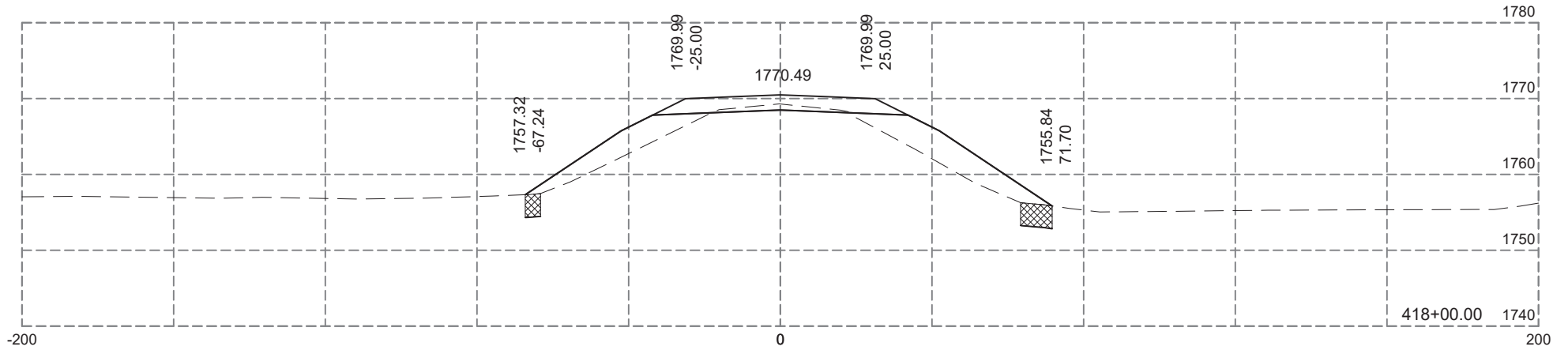

Plotting Date: 12-04-2024

STATE OF SOUTH DAKOTA	PROJECT	SHEET	TOTAL SHEETS
	P-PH-PT 0025(81)158	X24	X99



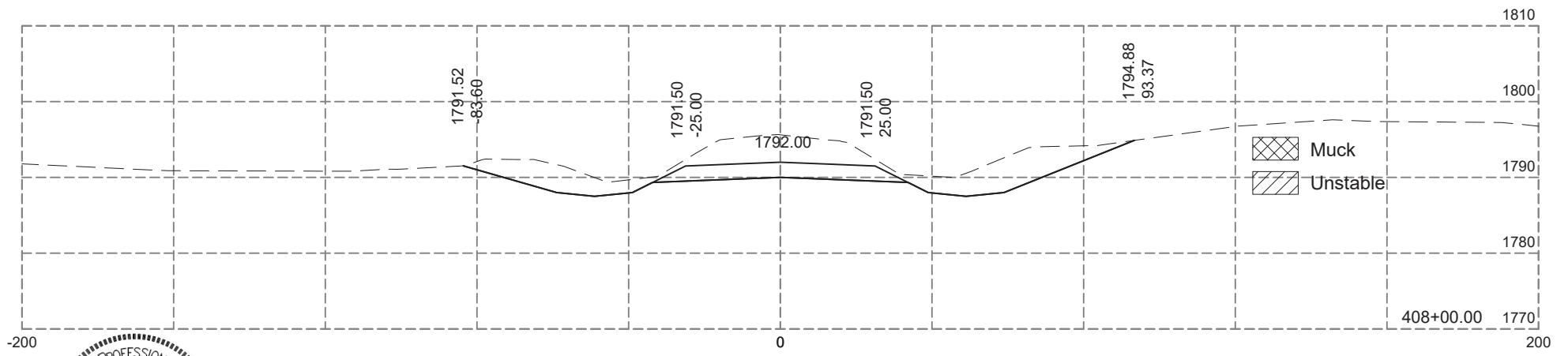
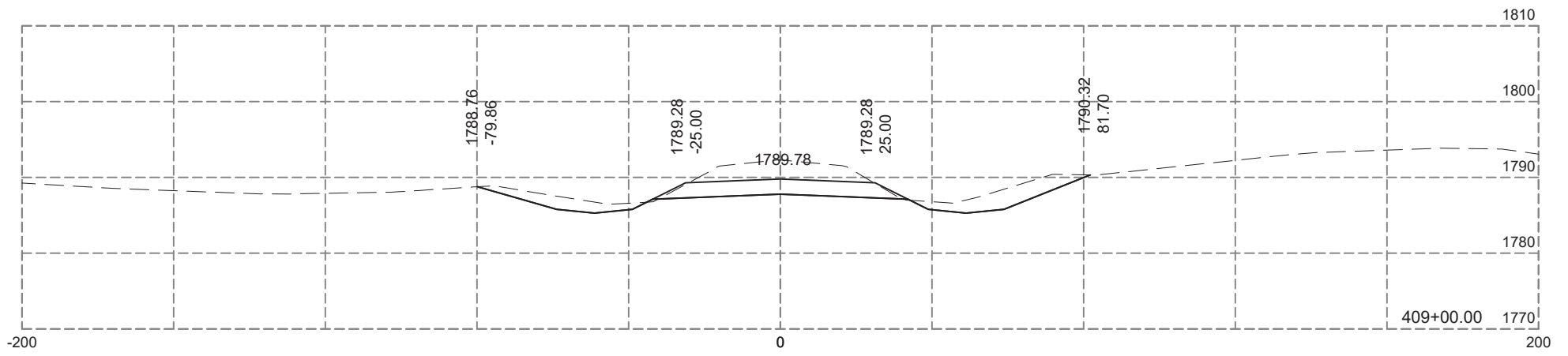
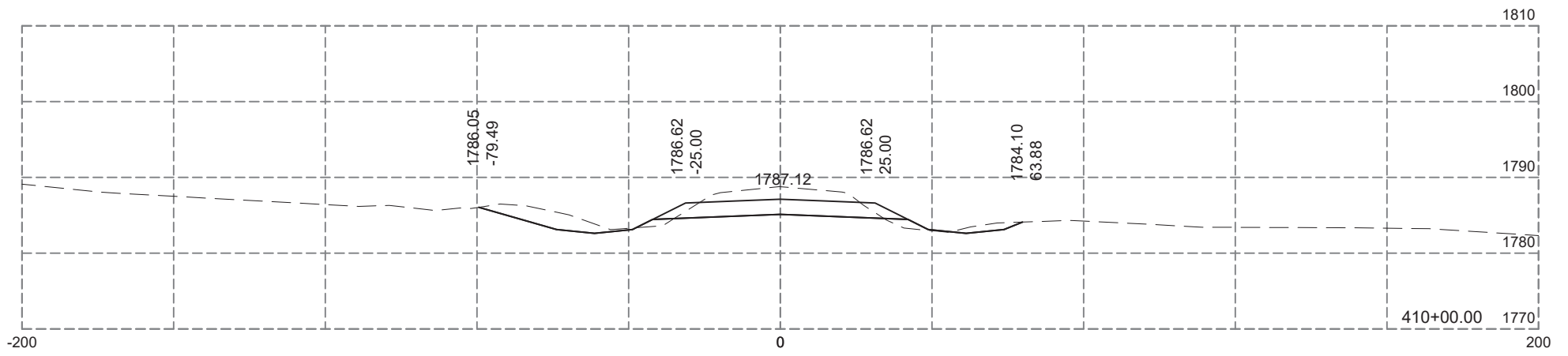
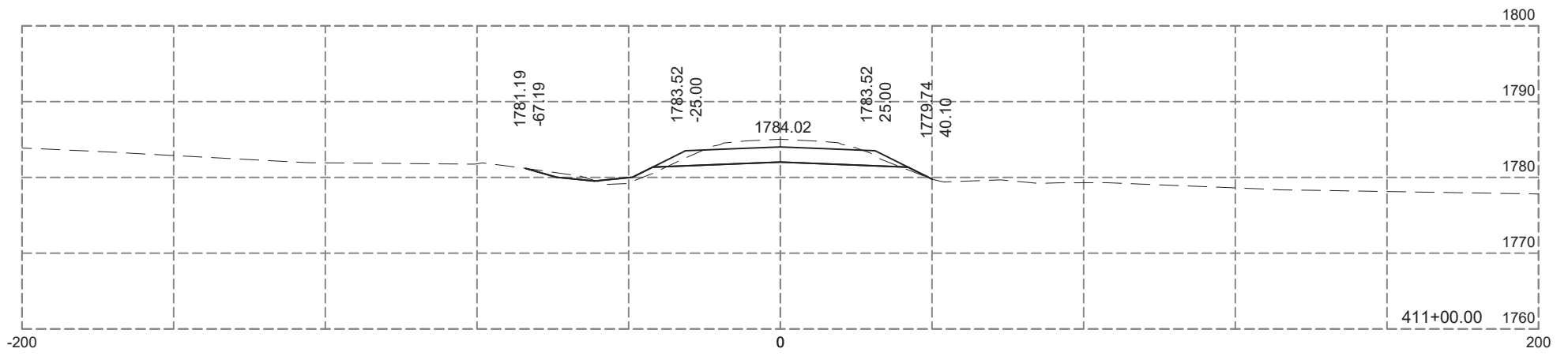
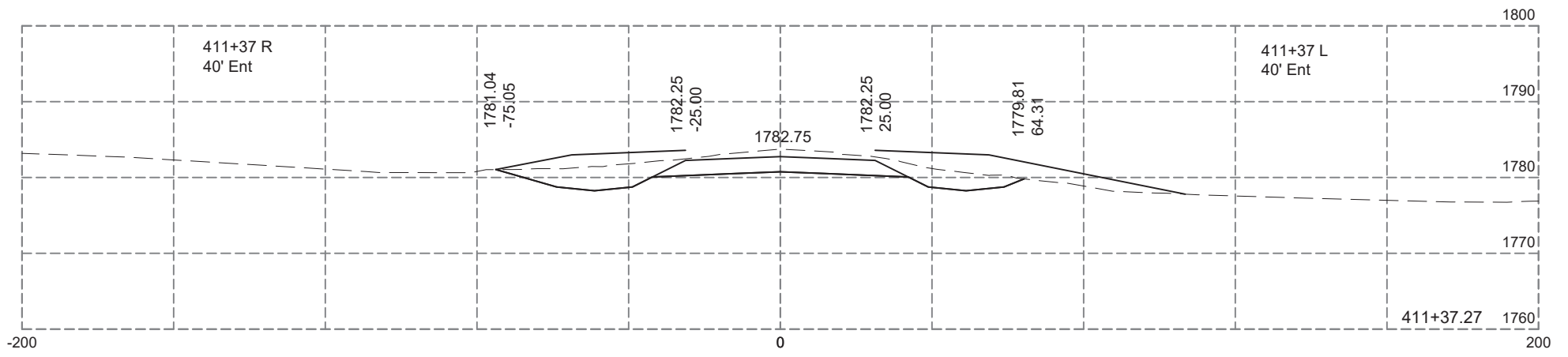
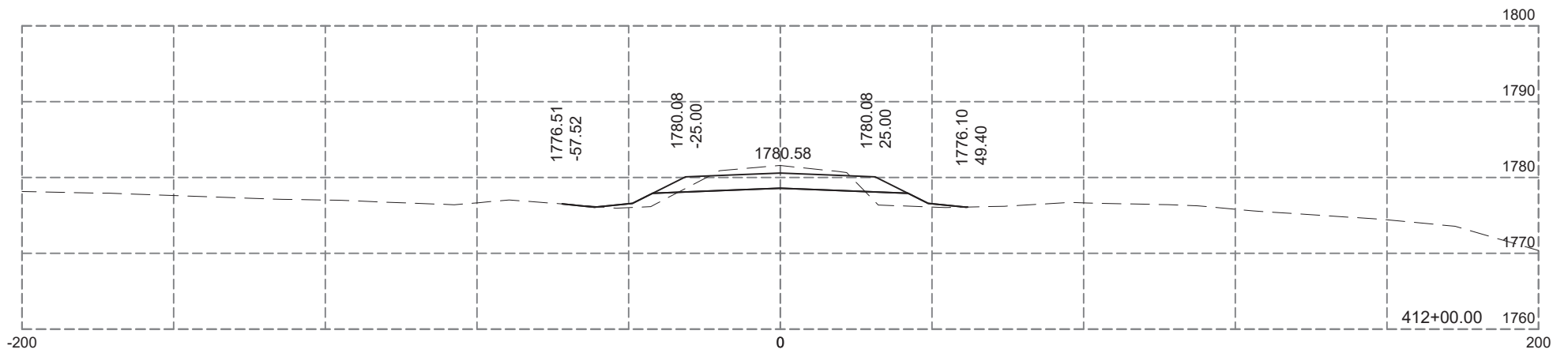

Plotting Date: 12-04-2024

STATE OF SOUTH DAKOTA	PROJECT P-PH-PT 0025(81)158	SHEET X25	TOTAL SHEETS X99
-----------------------	--------------------------------	--------------	---------------------

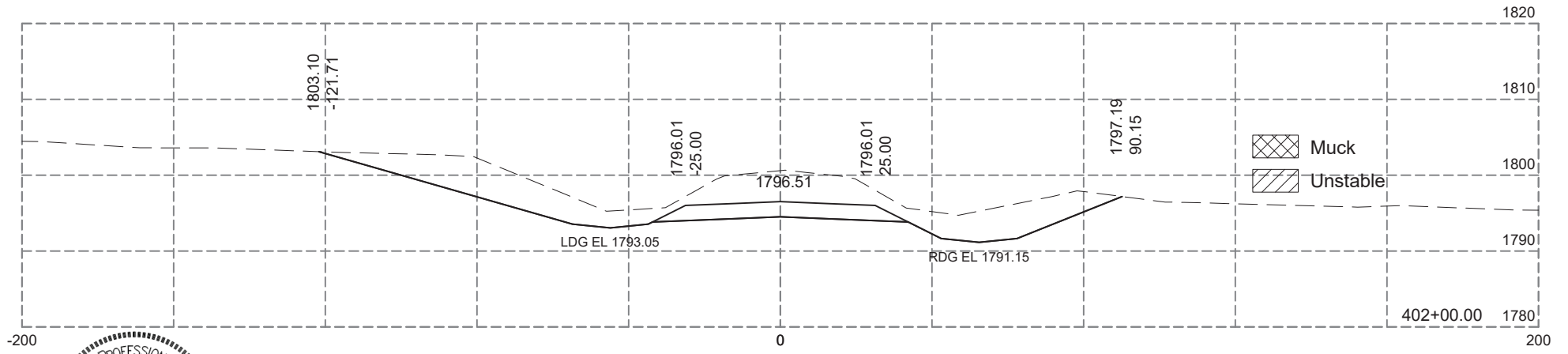
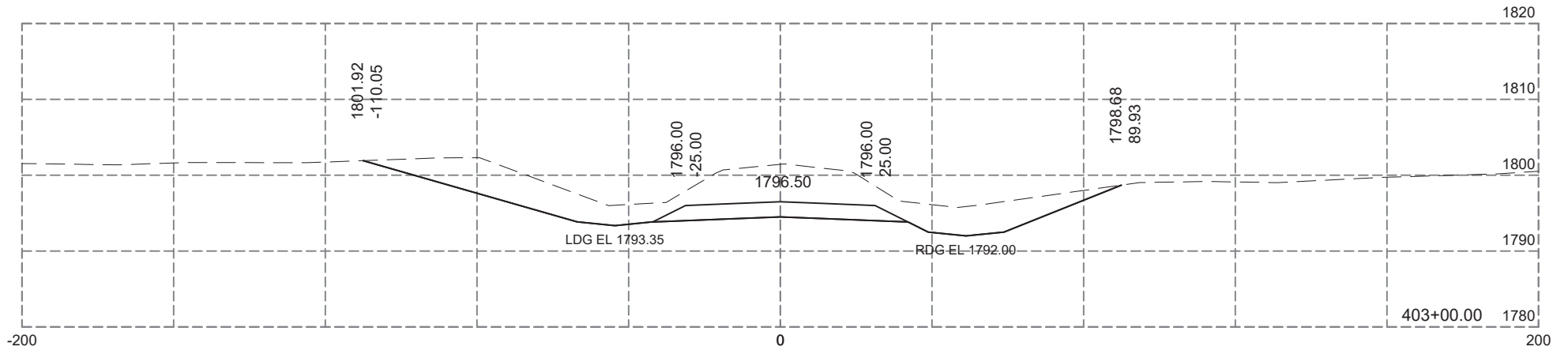
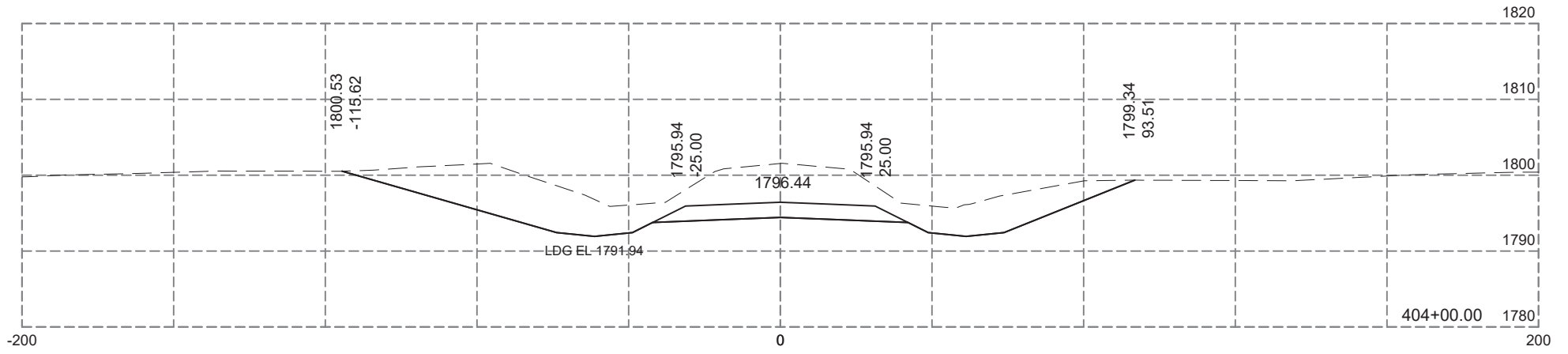
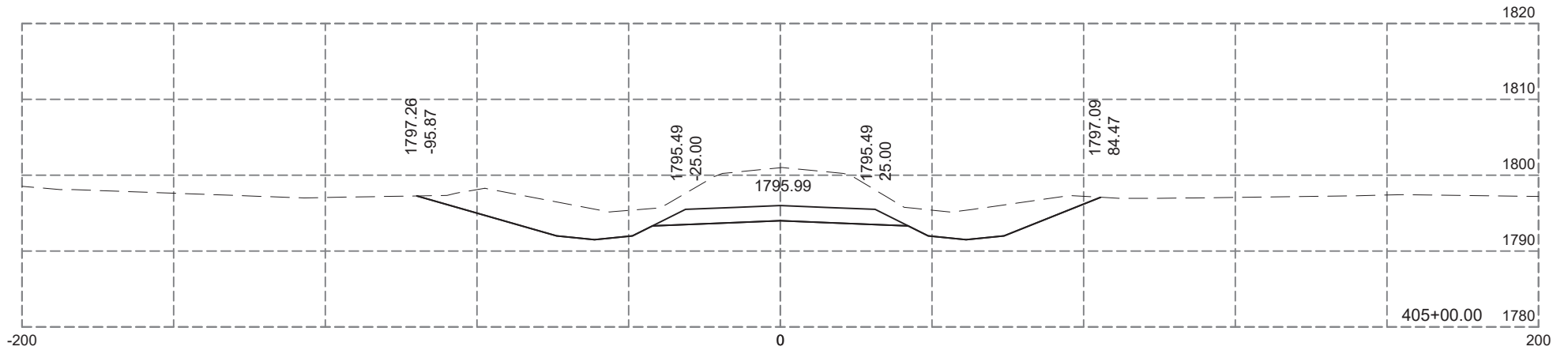
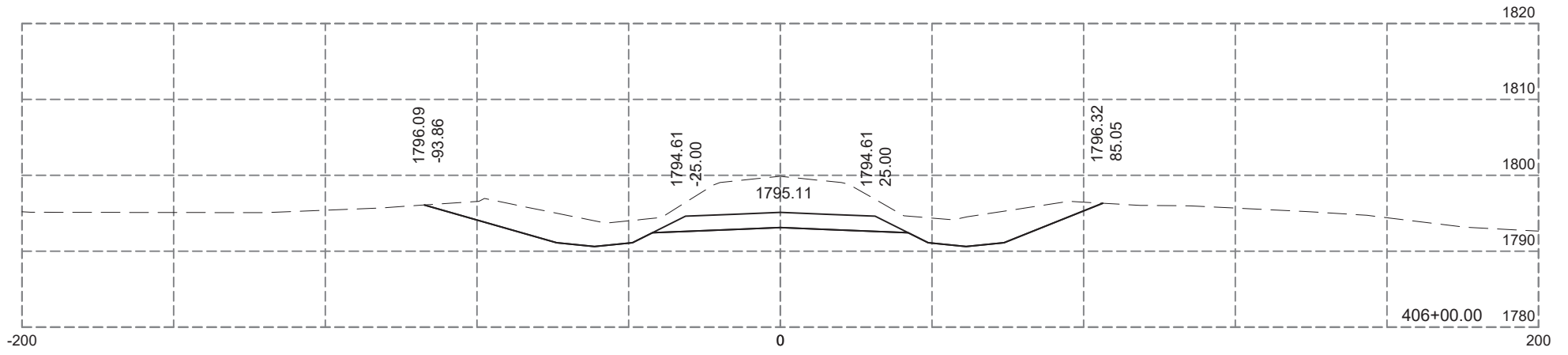
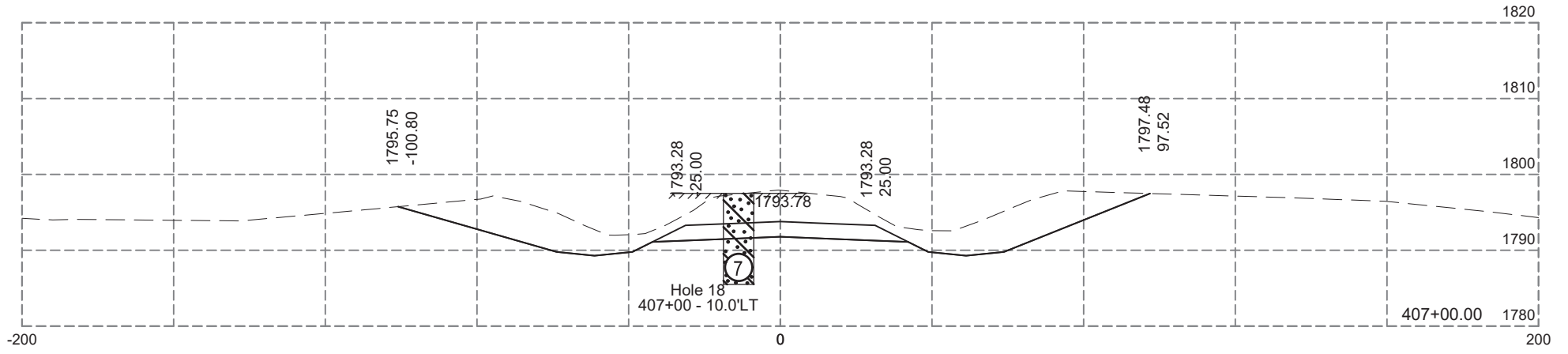

Plotting Date: 12-04-2024

STATE OF SOUTH DAKOTA	PROJECT P-PH-PT 0025(81)158	SHEET X26	TOTAL SHEETS X99
-----------------------	--------------------------------	--------------	---------------------

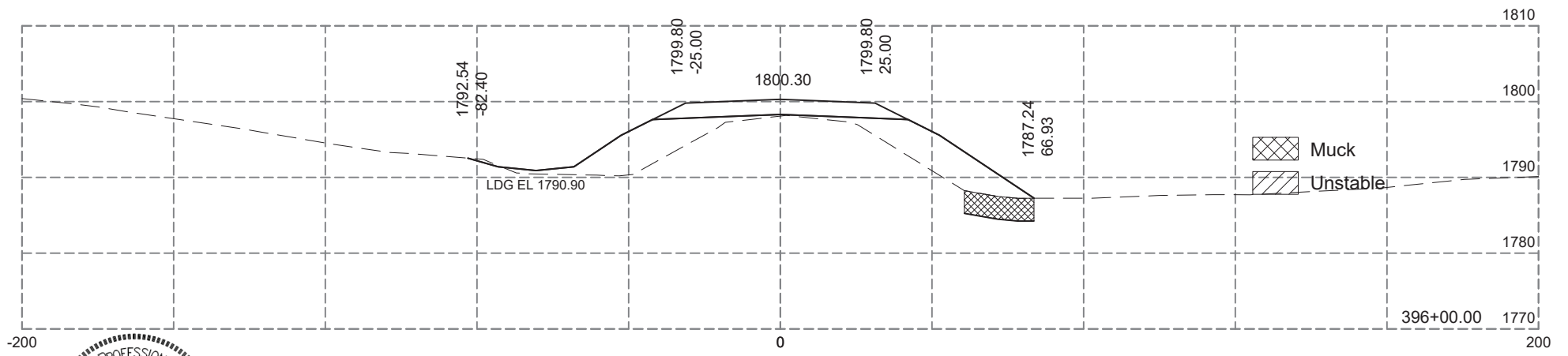
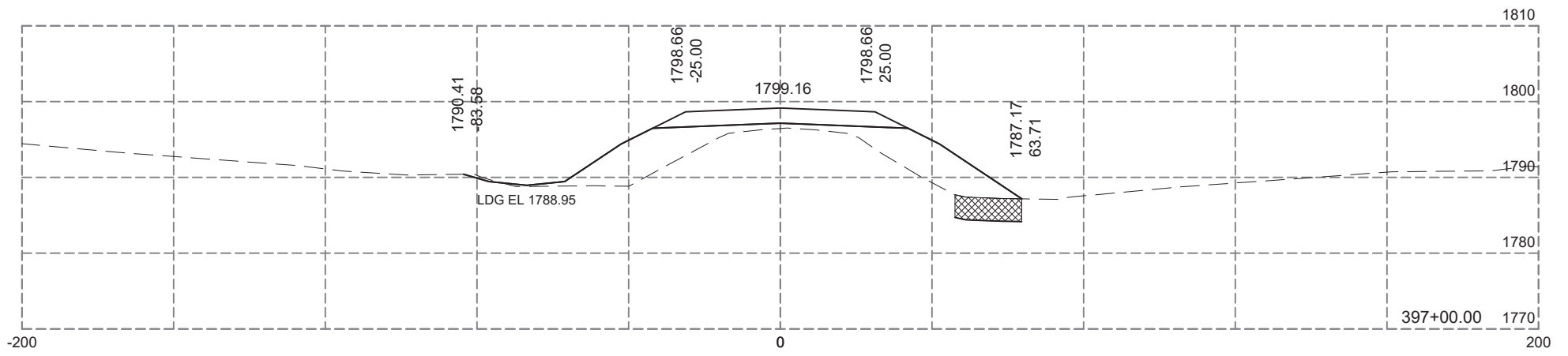
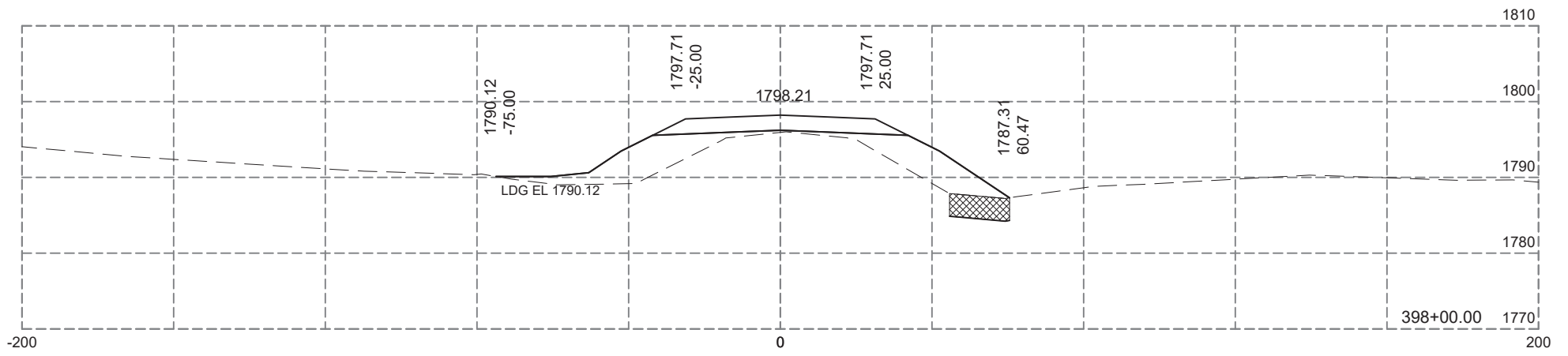
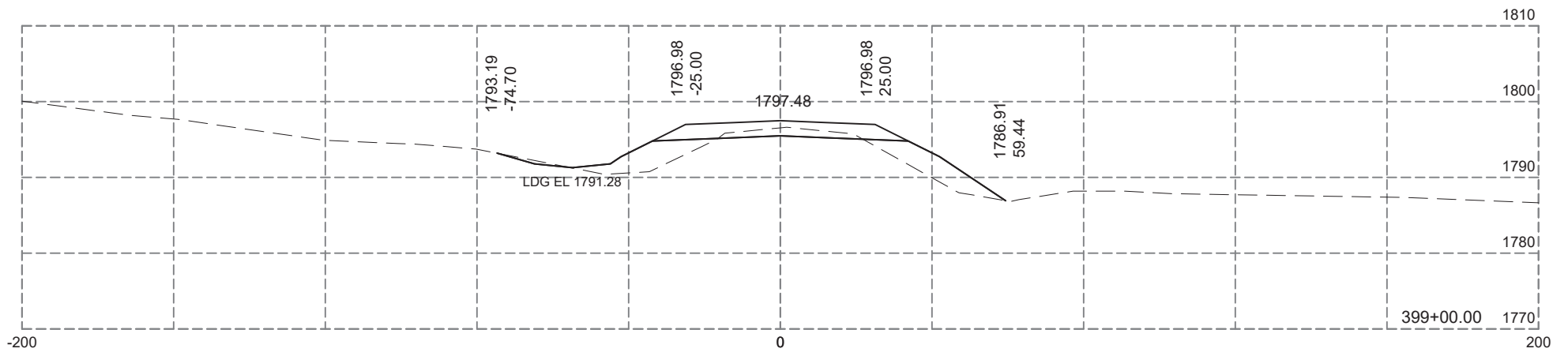
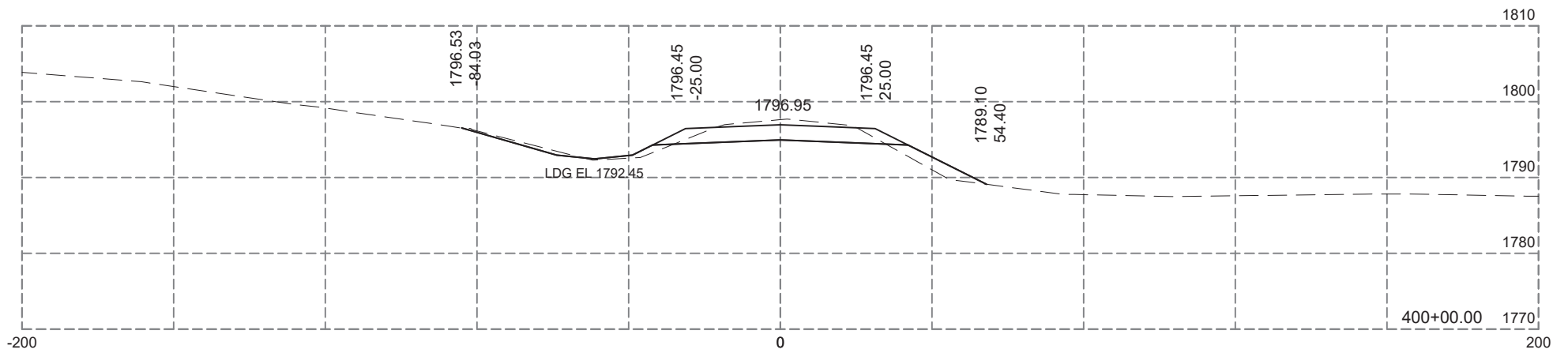
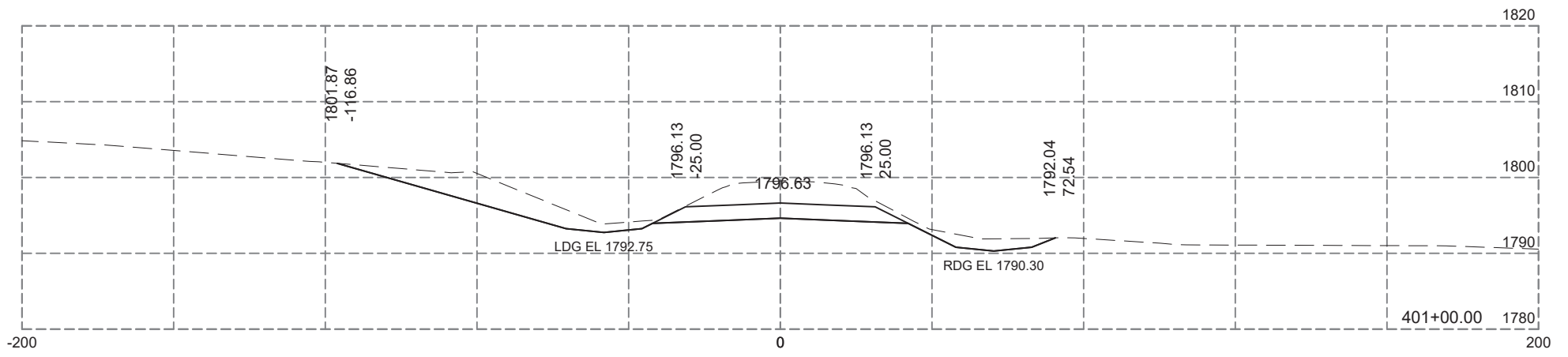

Plotting Date: 12-04-2024

STATE OF SOUTH DAKOTA	PROJECT P-PH-PT 0025(81)158	SHEET X27	TOTAL SHEETS X99
-----------------------	--------------------------------	--------------	---------------------

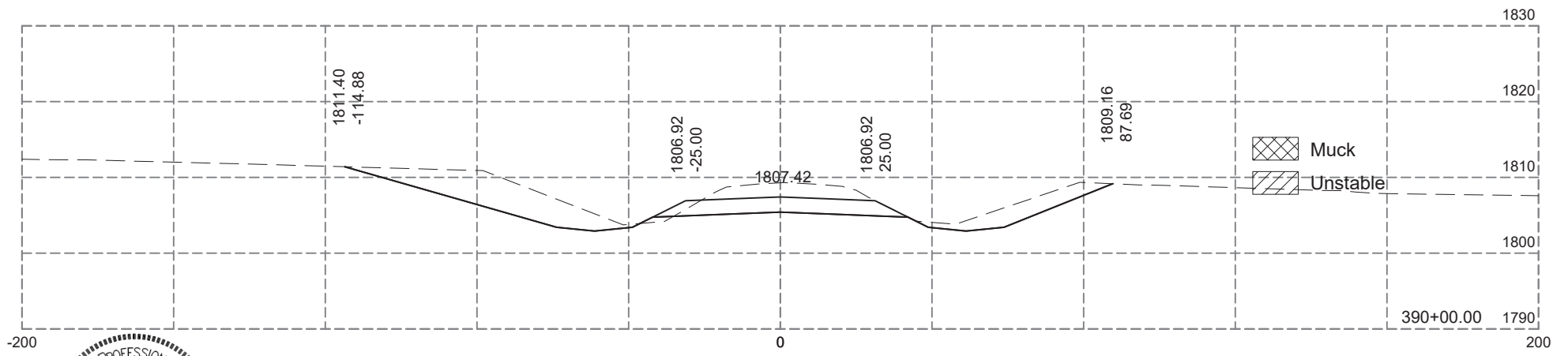
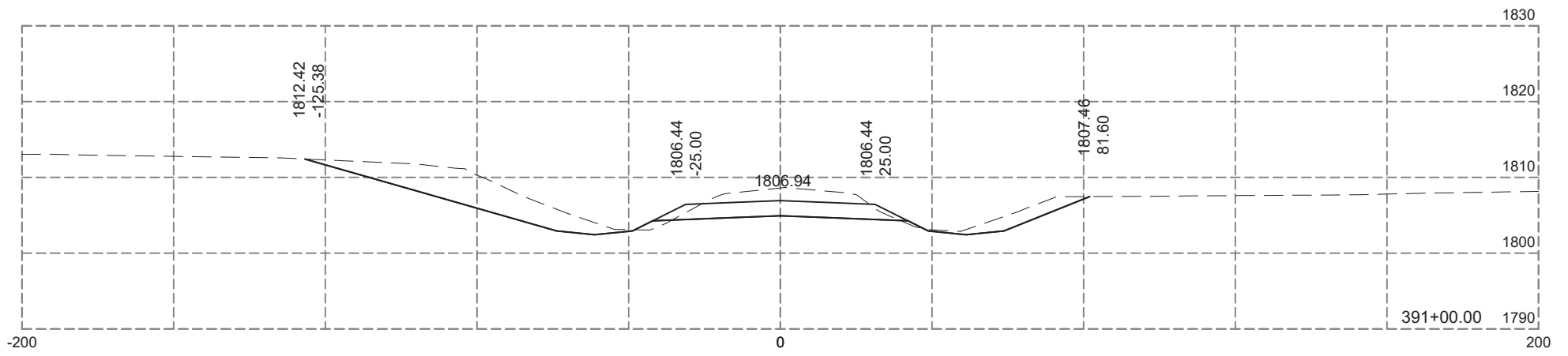
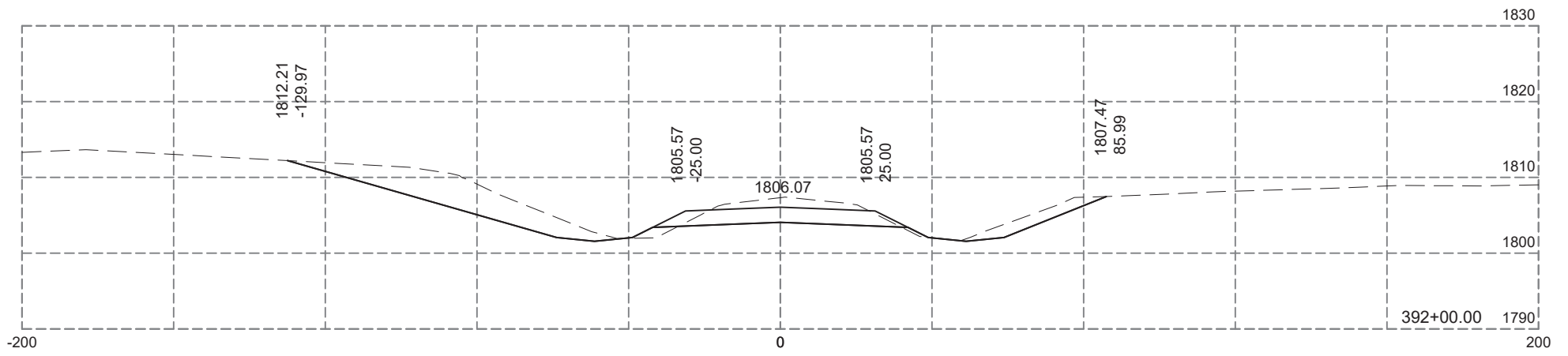
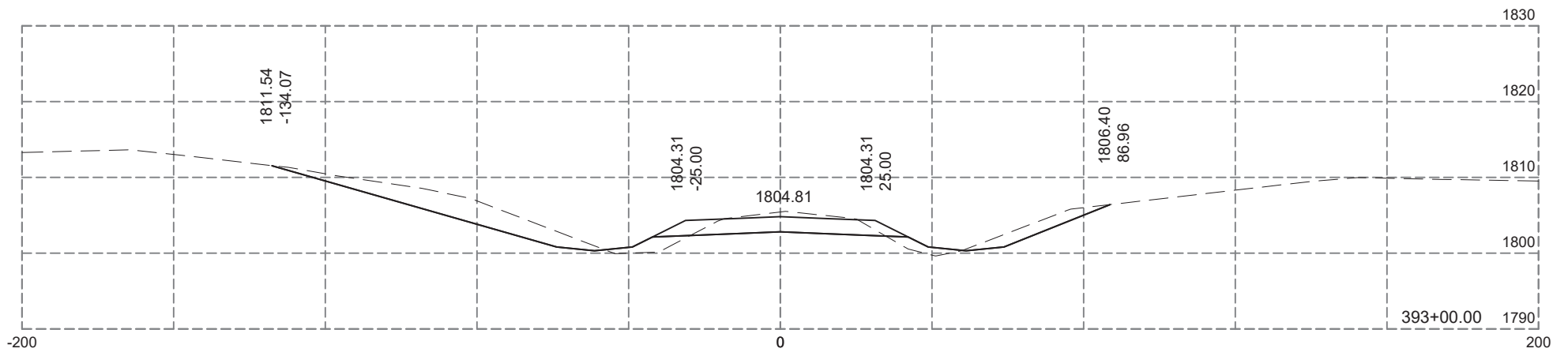
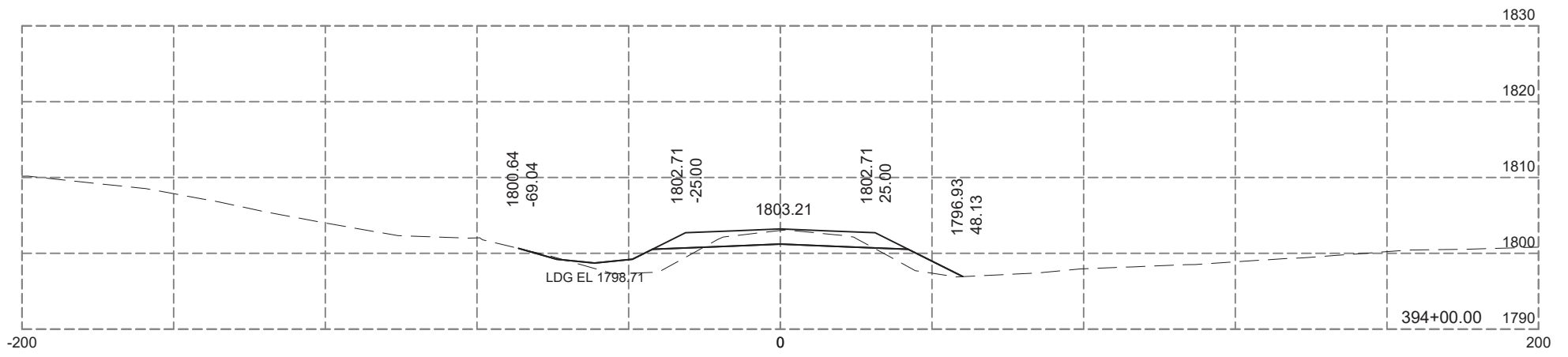
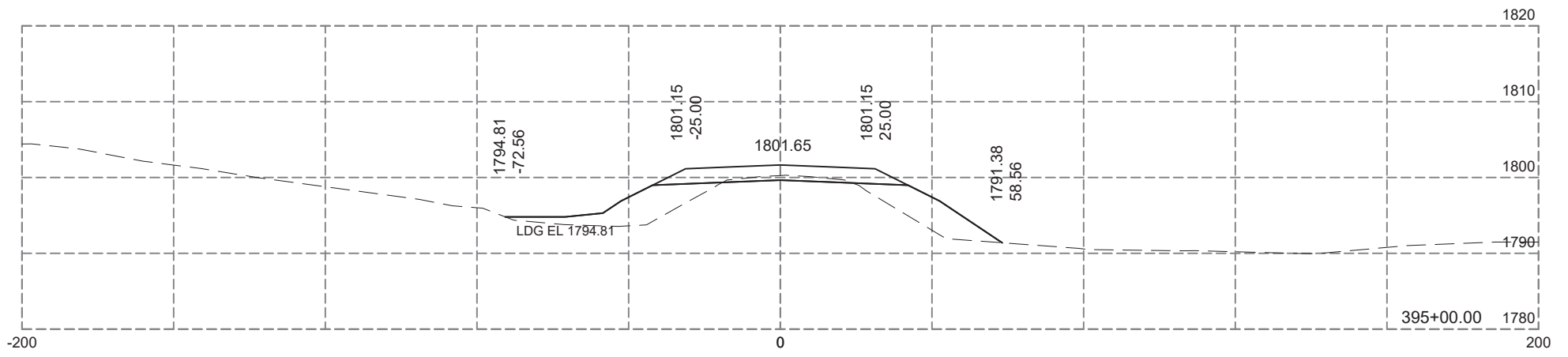

Plotting Date: 12-04-2024

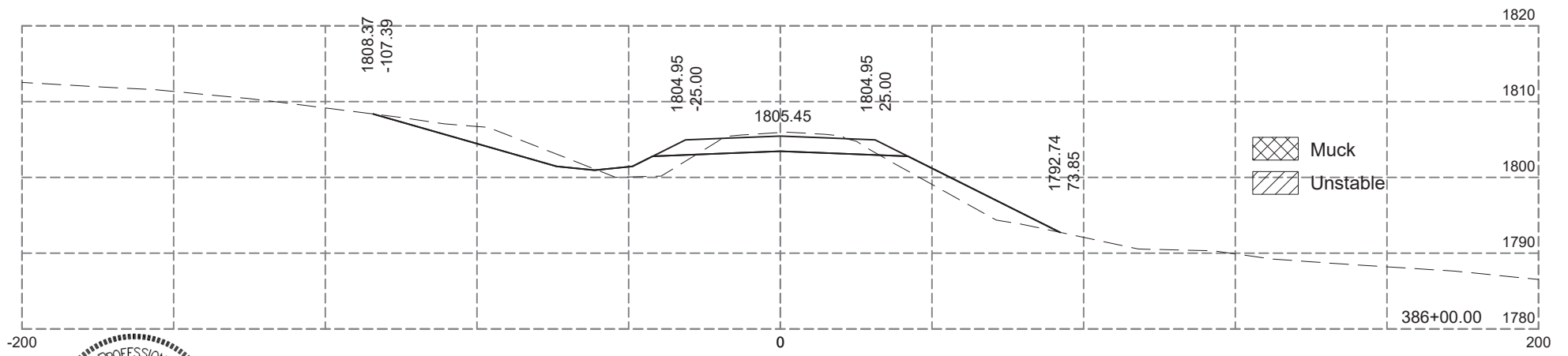
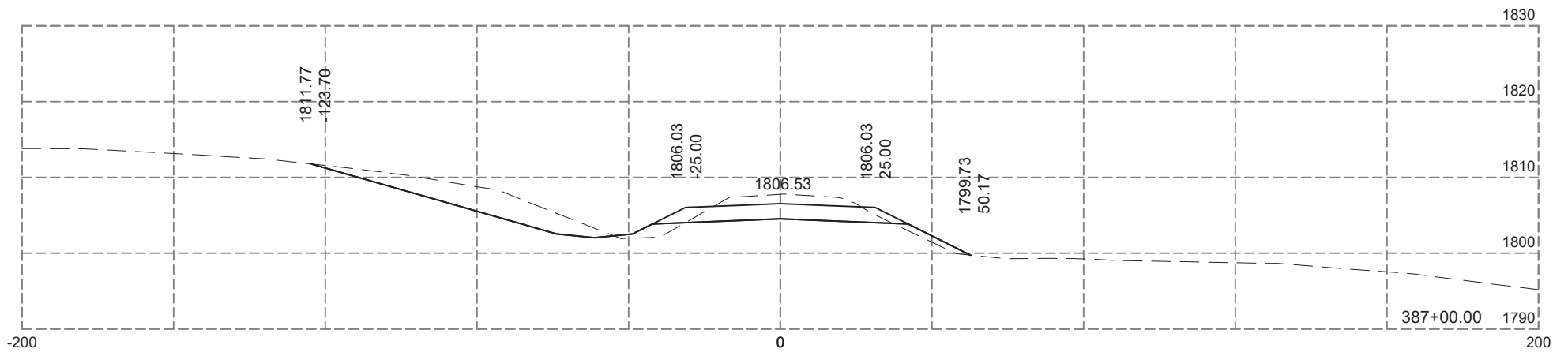
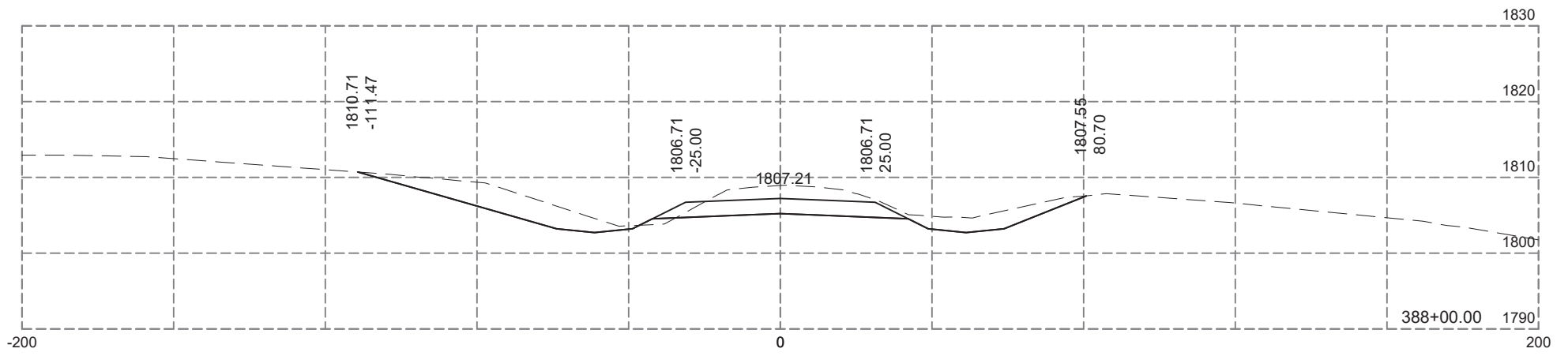
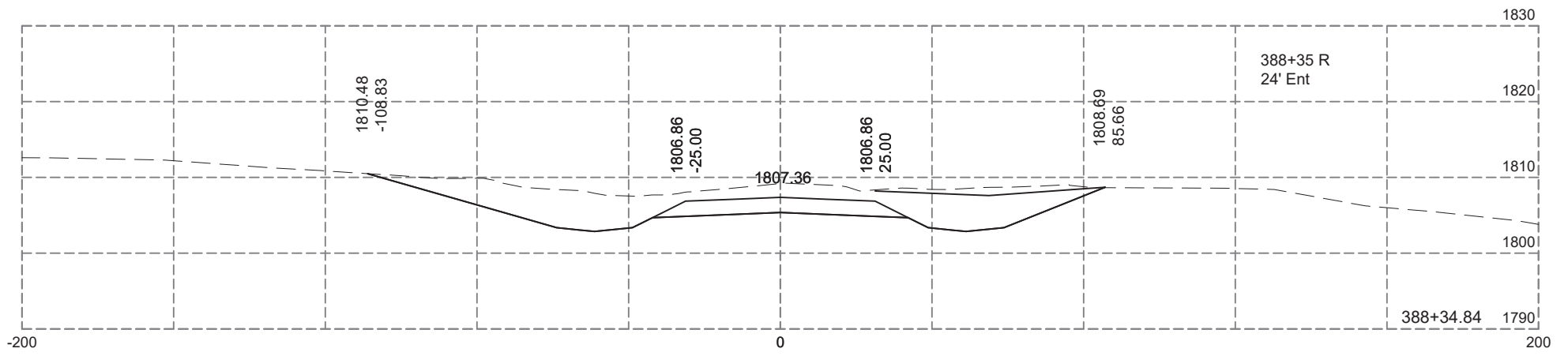
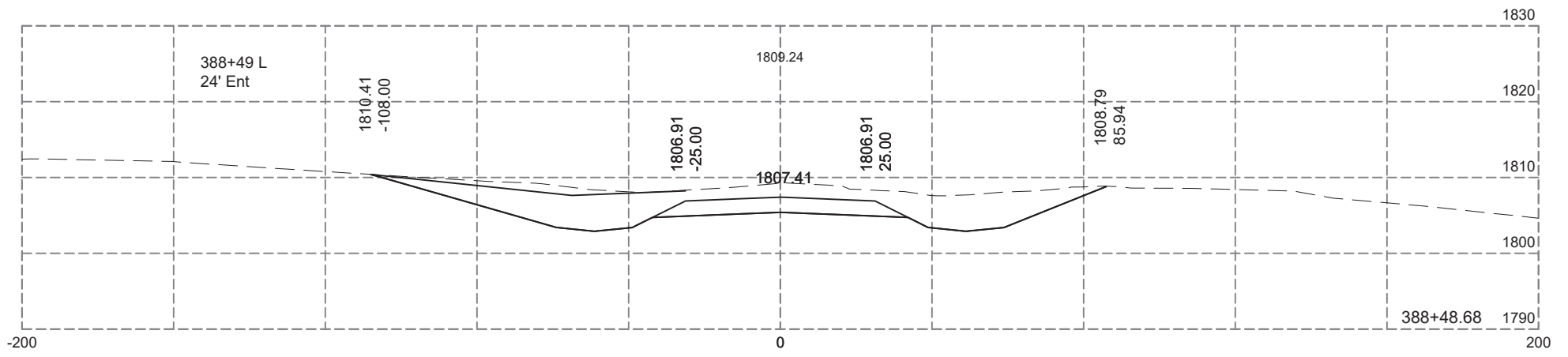
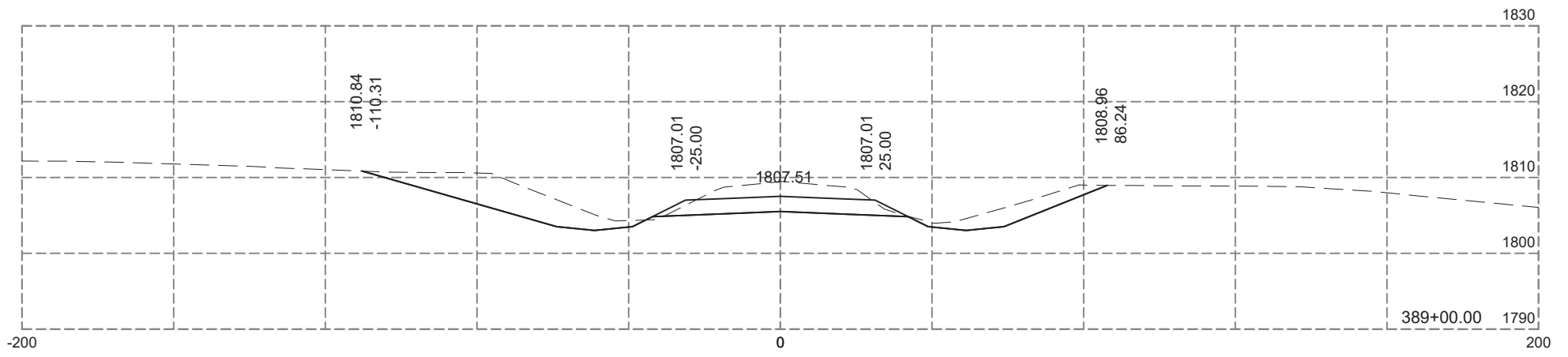

STATE OF SOUTH DAKOTA	PROJECT P-PH-PT 0025(81)158	SHEET X28	TOTAL SHEETS X99
-----------------------	--------------------------------	--------------	---------------------

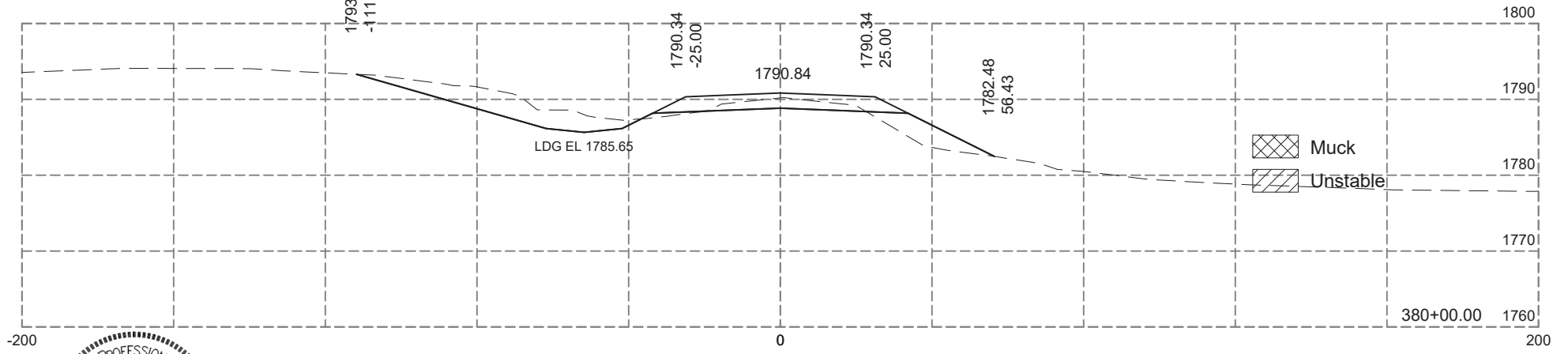
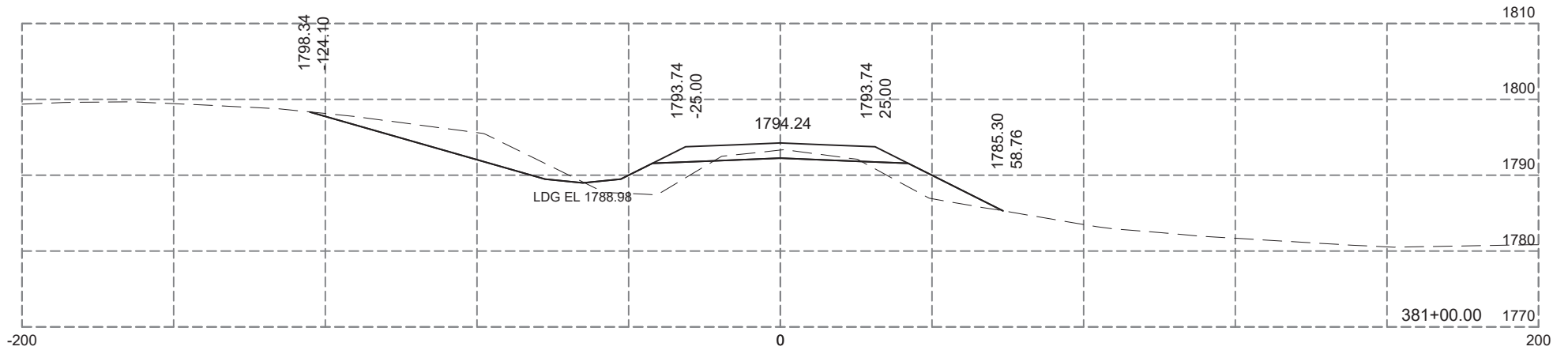
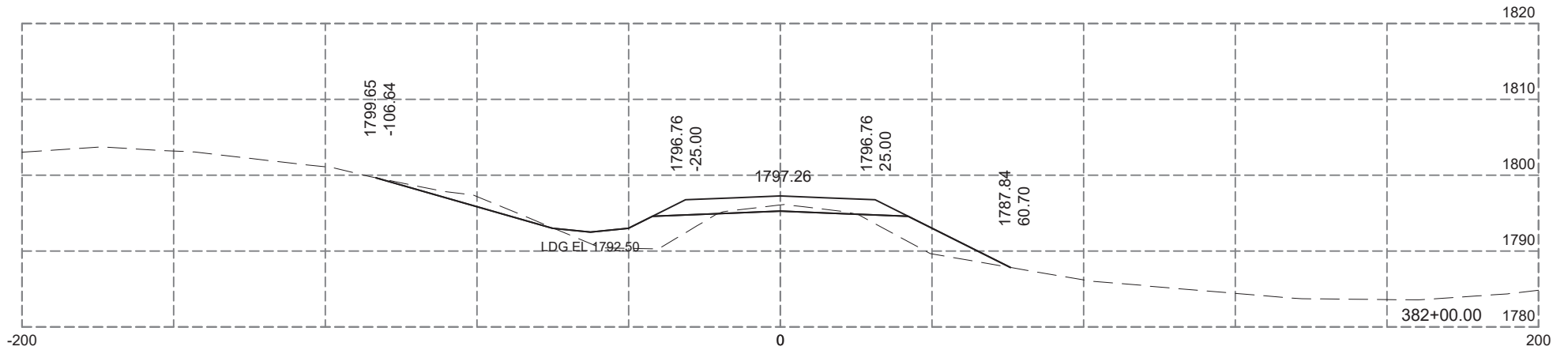
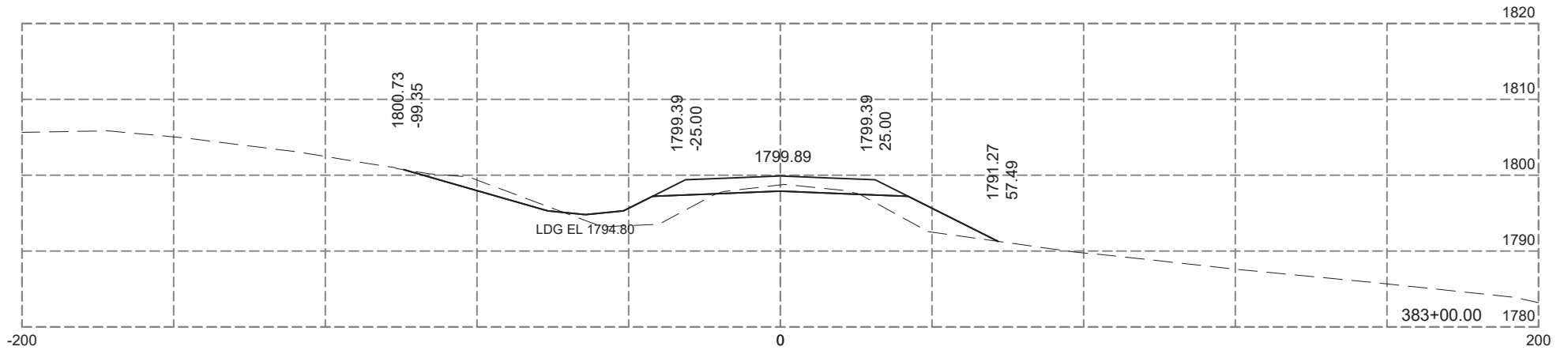
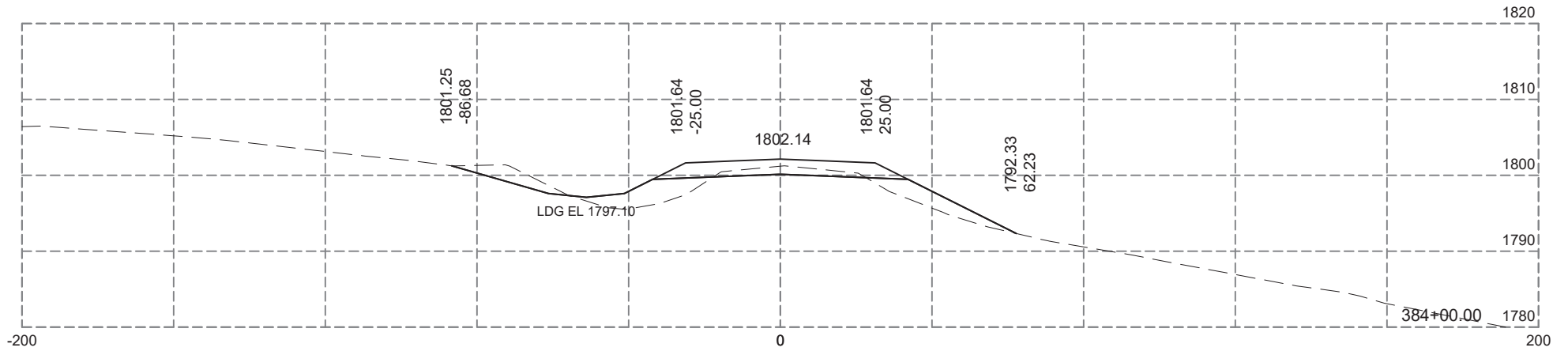
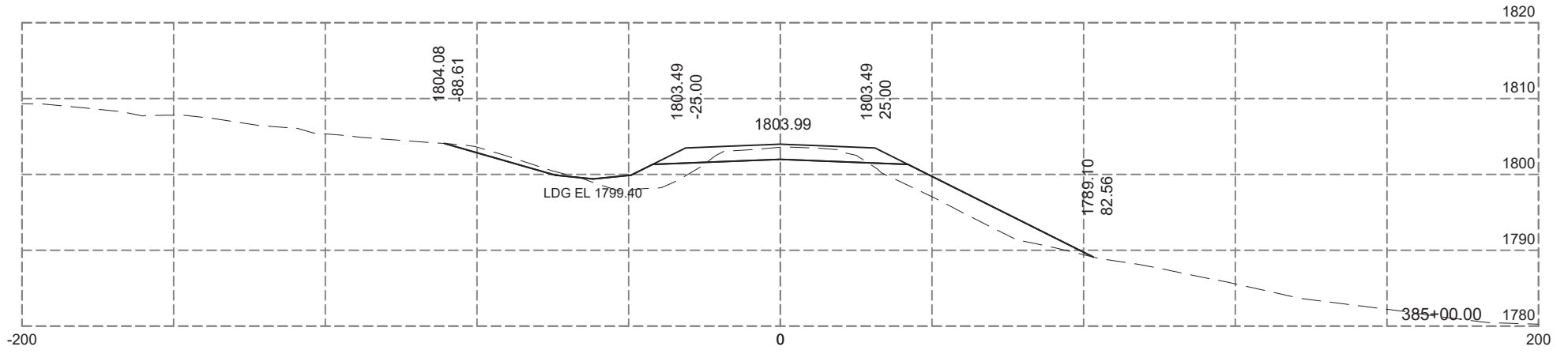

Plotting Date: 12-04-2024

STATE OF SOUTH DAKOTA	PROJECT P-PH-PT 0025(81)158	SHEET X29	TOTAL SHEETS X99
-----------------------	--------------------------------	--------------	---------------------



 Muck  
 Unstable



Plotting Date: 12-04-2024

STATE OF SOUTH DAKOTA	PROJECT P-PH-PT 0025(81)158	SHEET X30	TOTAL SHEETS X99
-----------------------	--------------------------------	--------------	---------------------

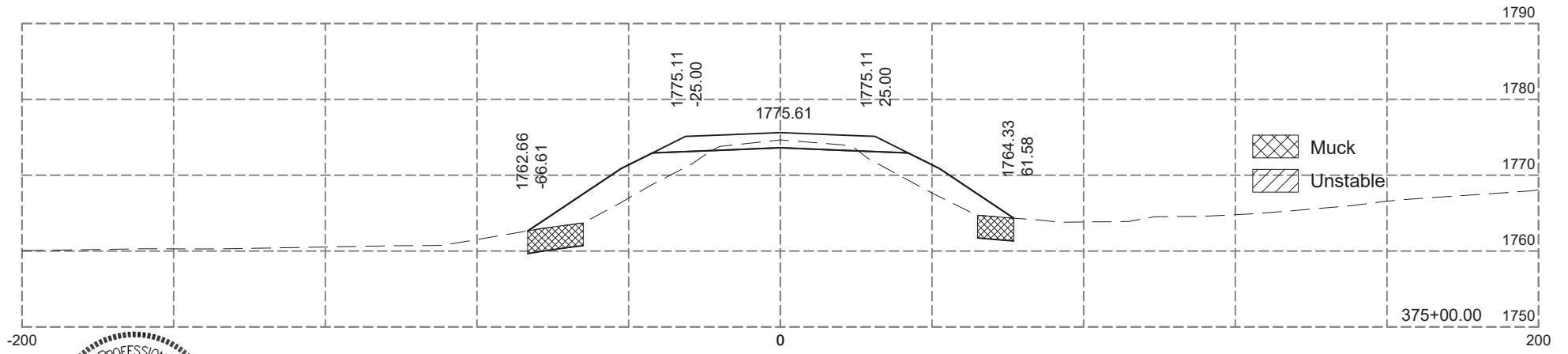
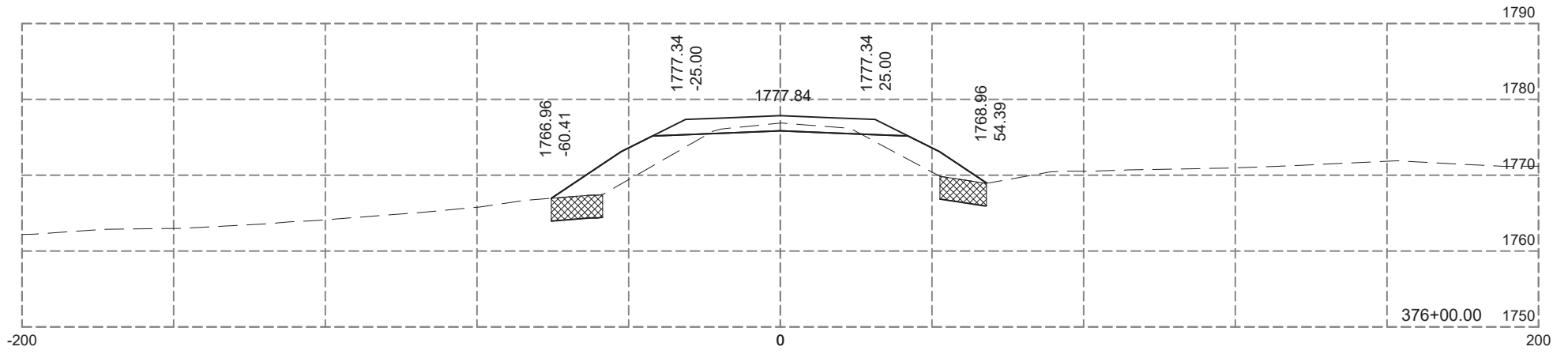
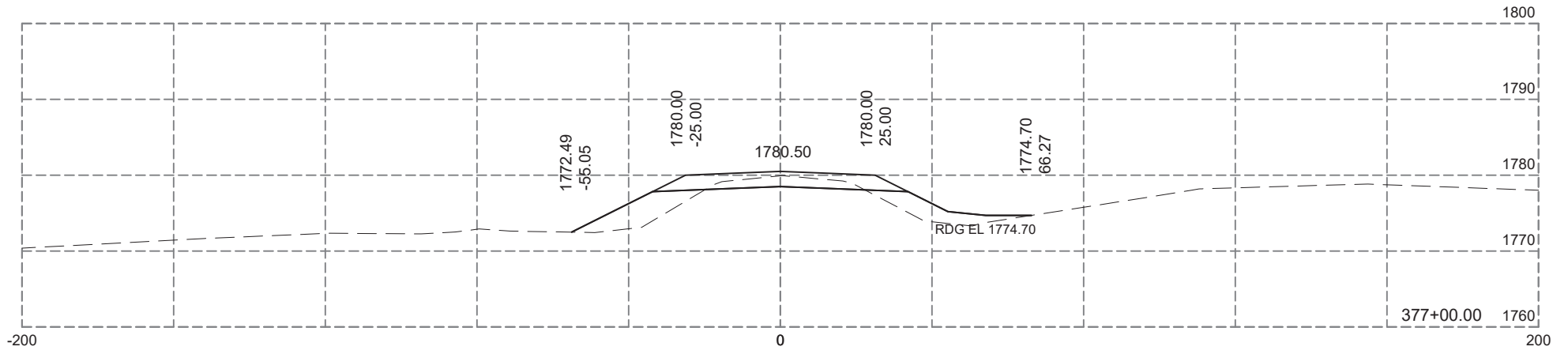
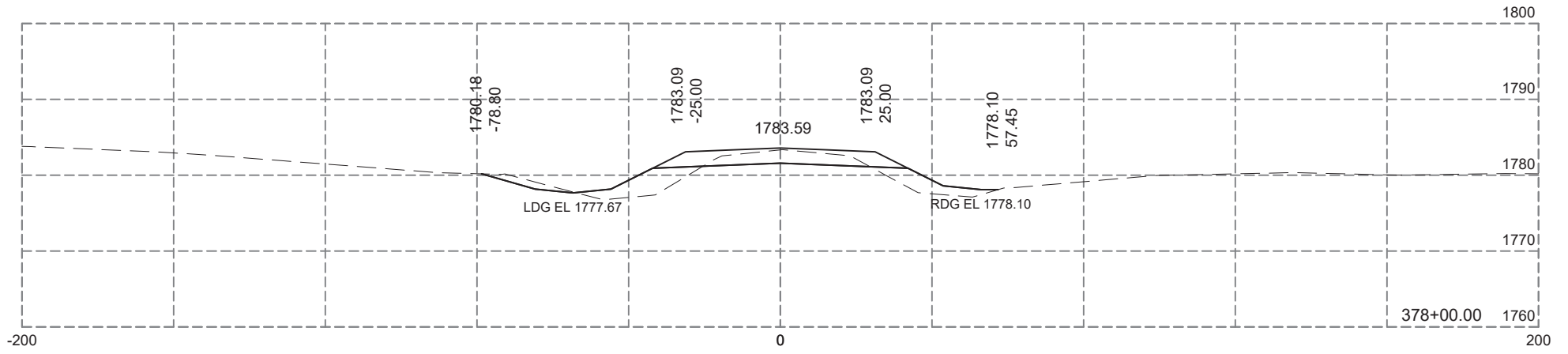
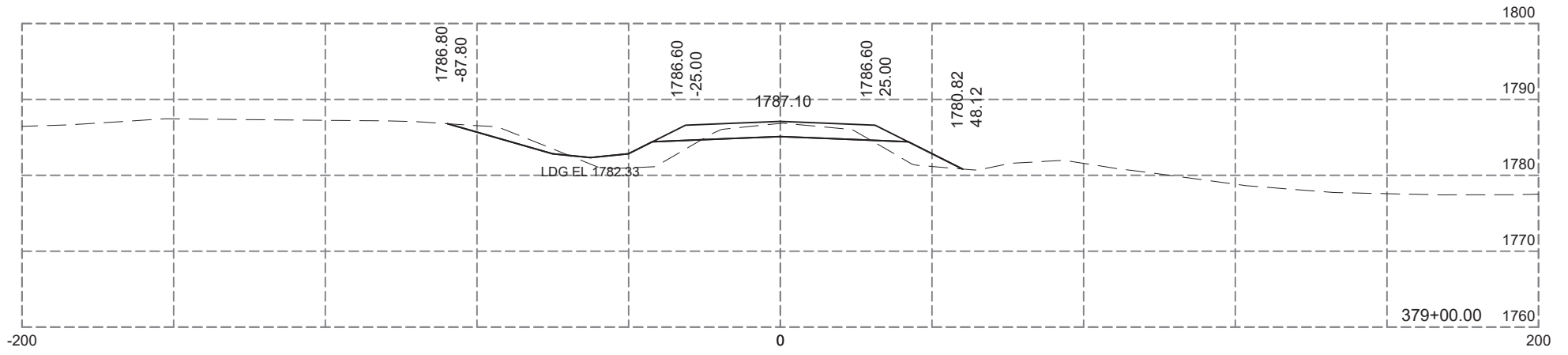
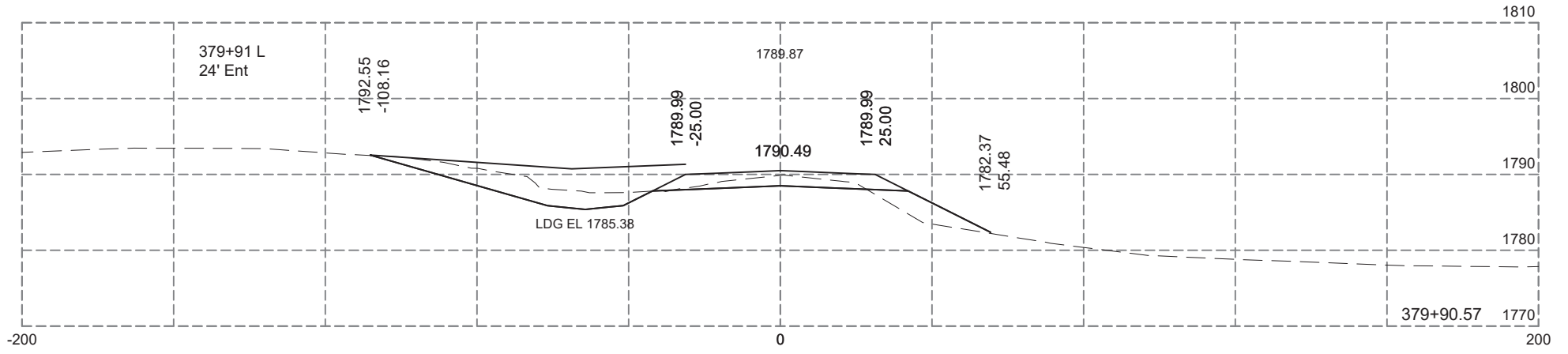

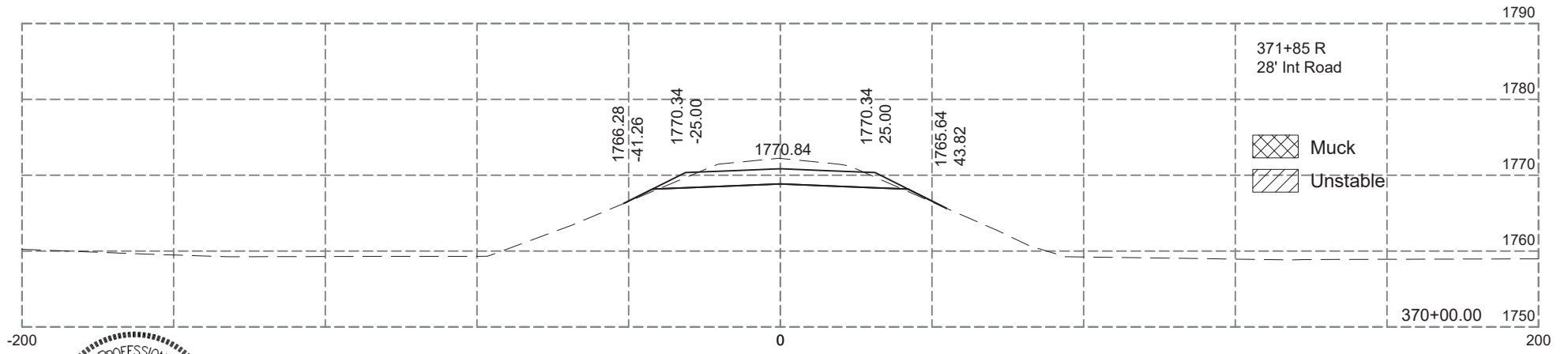
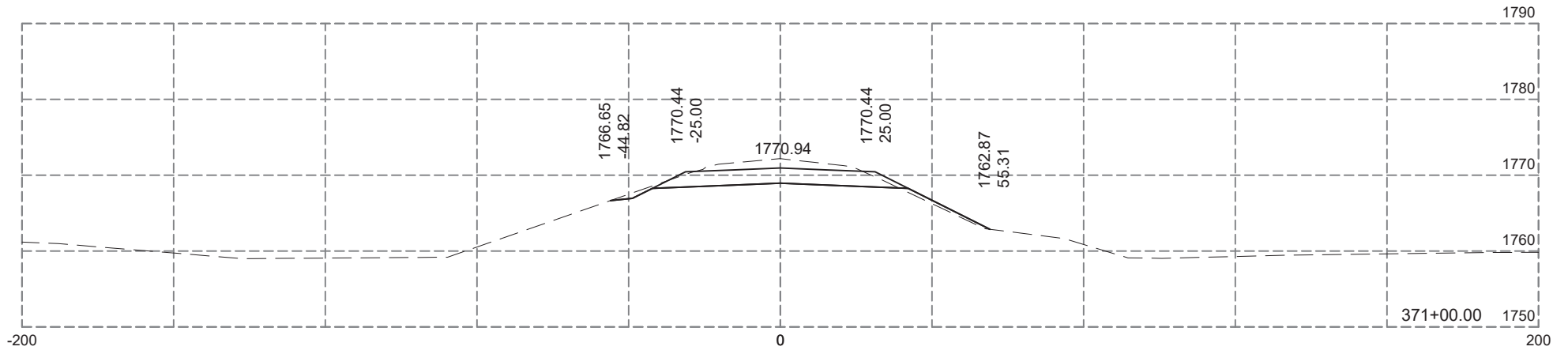
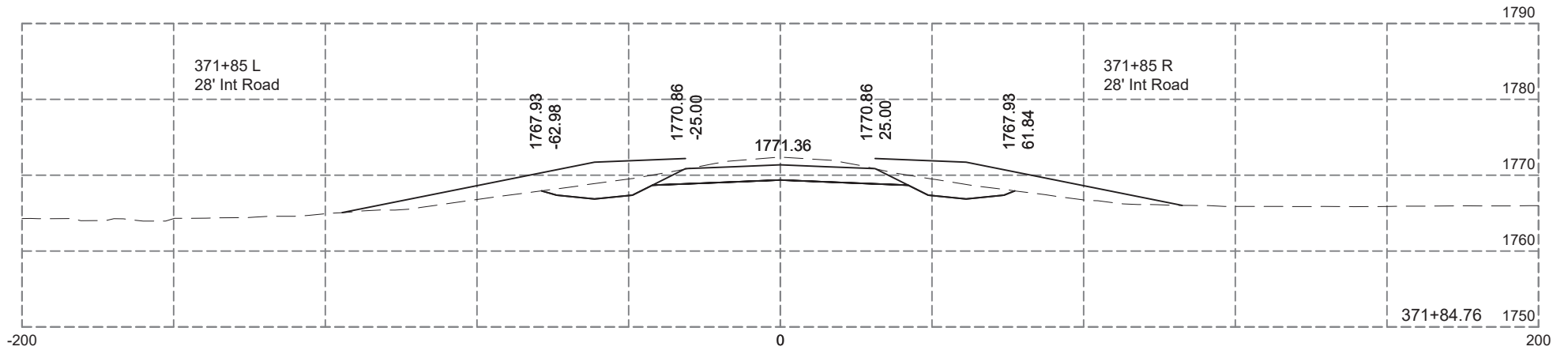
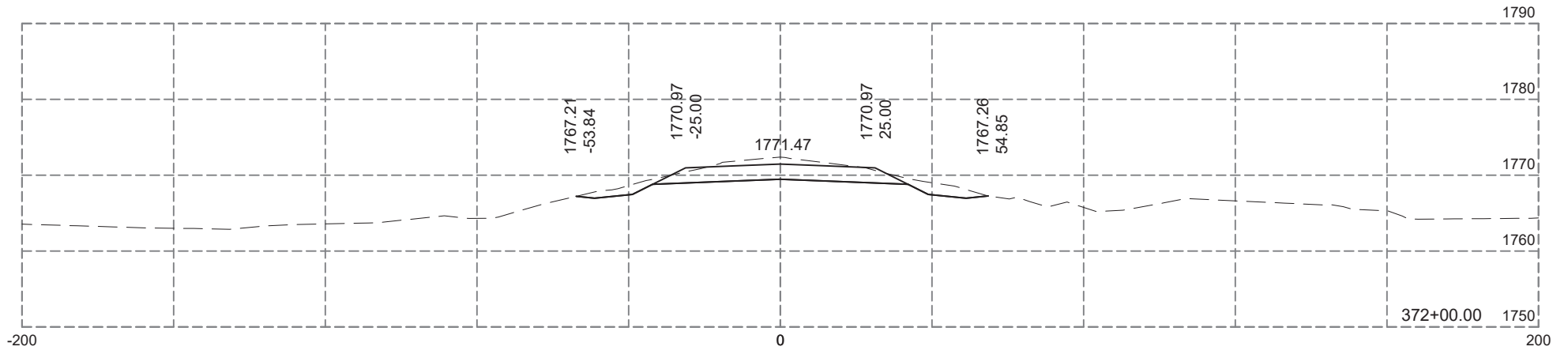
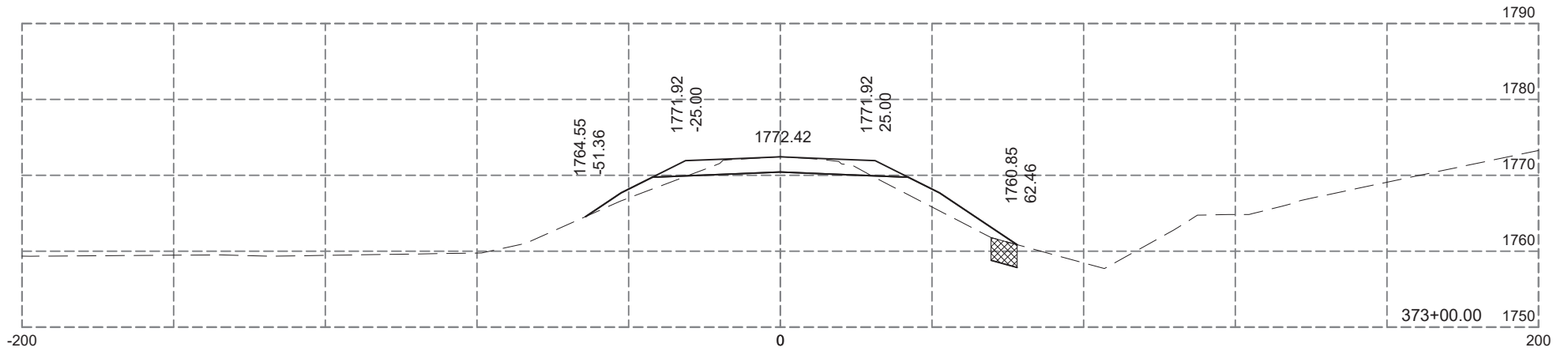
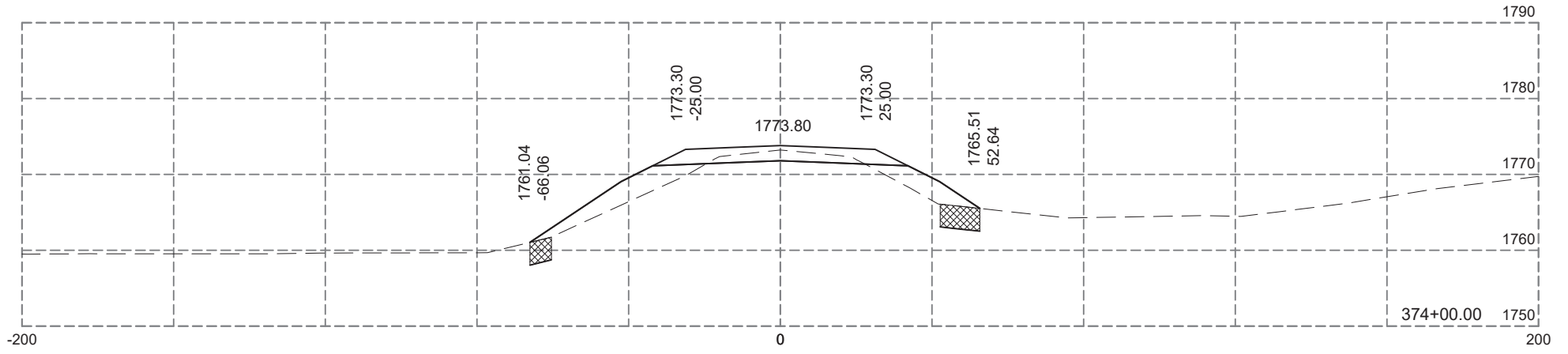

Plotting Date: 12-04-2024

STATE OF SOUTH DAKOTA	PROJECT P-PH-PT 0025(81)158	SHEET X31	TOTAL SHEETS X99
-----------------------	--------------------------------	--------------	---------------------



371+85 R  
28' Int Road

 Muck  
 Unstable



Plotting Date: 12-04-2024

STATE OF SOUTH DAKOTA	PROJECT P-PH-PT 0025(81)158	SHEET X32	TOTAL SHEETS X99
-----------------------	--------------------------------	--------------	---------------------



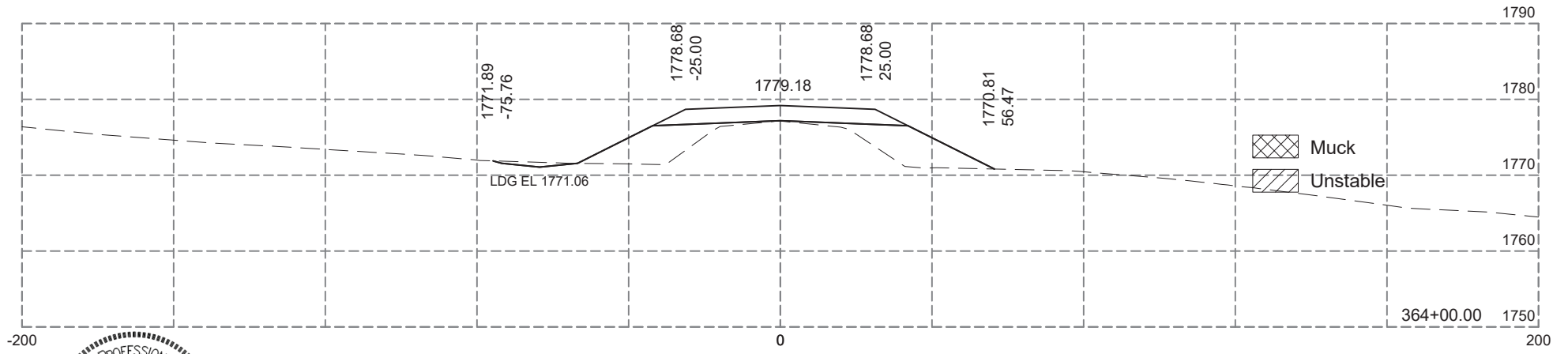
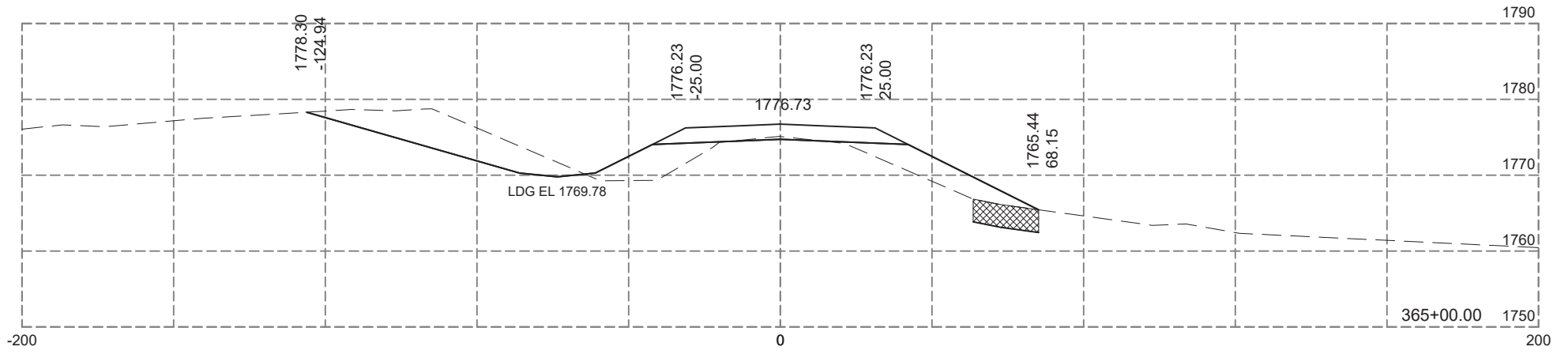
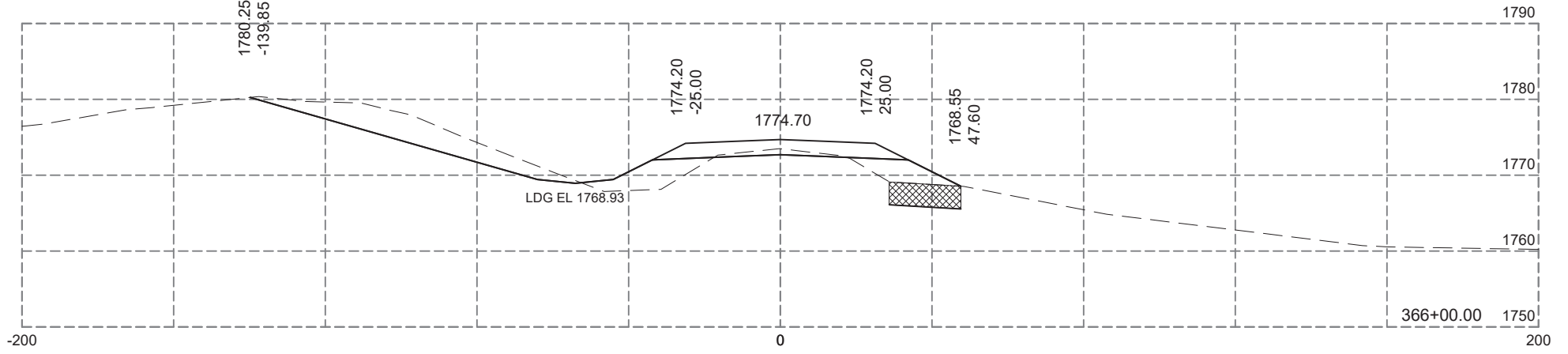
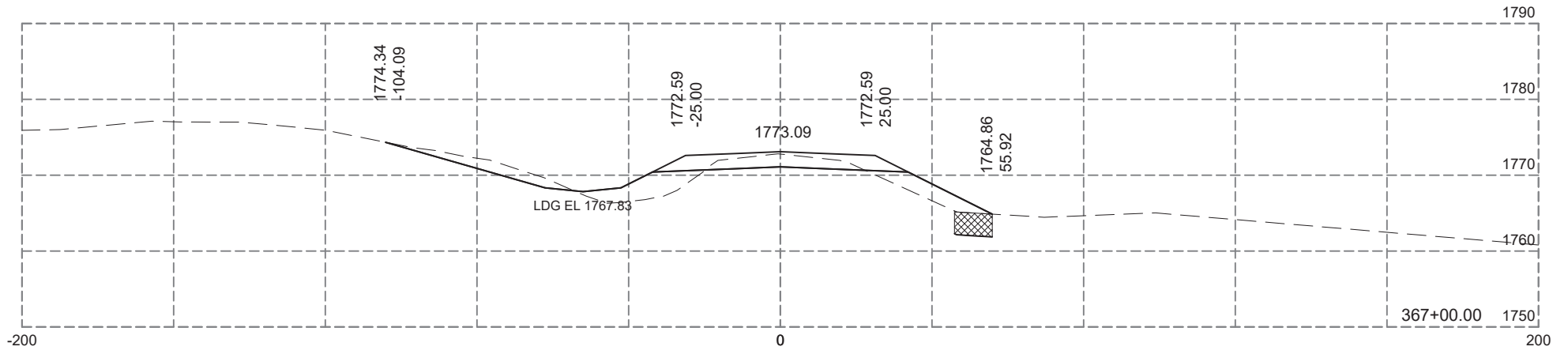
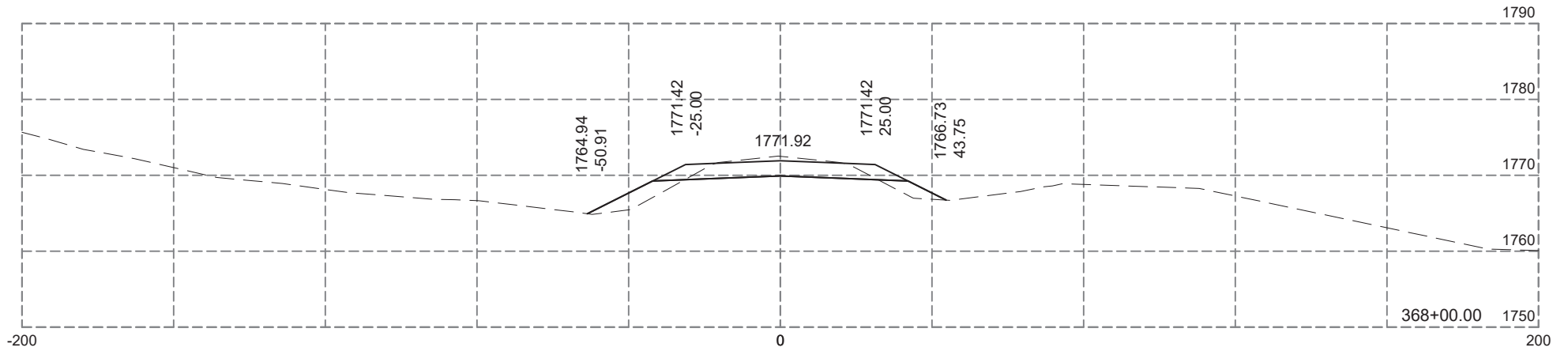
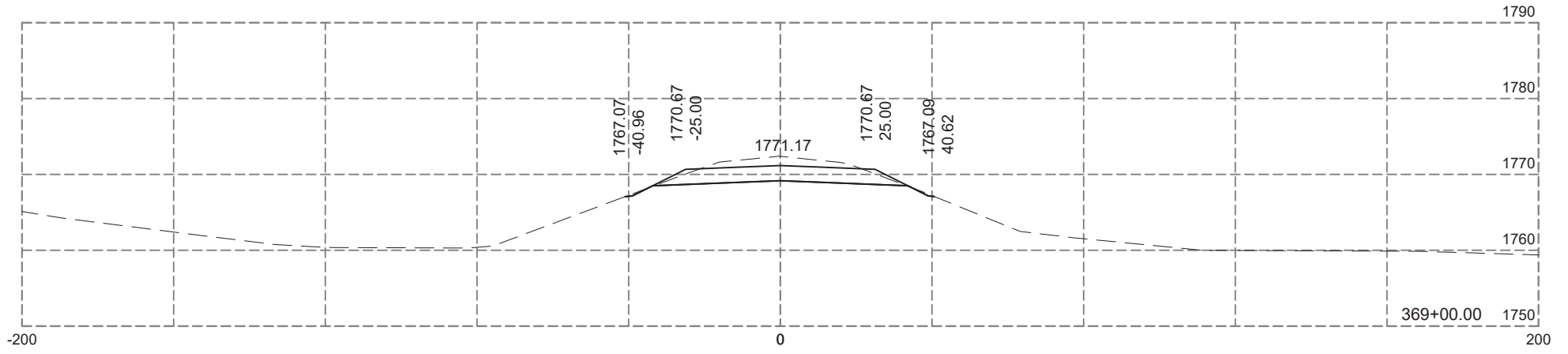

Plotting Date: 12-04-2024

STATE OF SOUTH DAKOTA	PROJECT P-PH-PT 0025(81)158	SHEET X33	TOTAL SHEETS X99
-----------------------	--------------------------------	--------------	---------------------

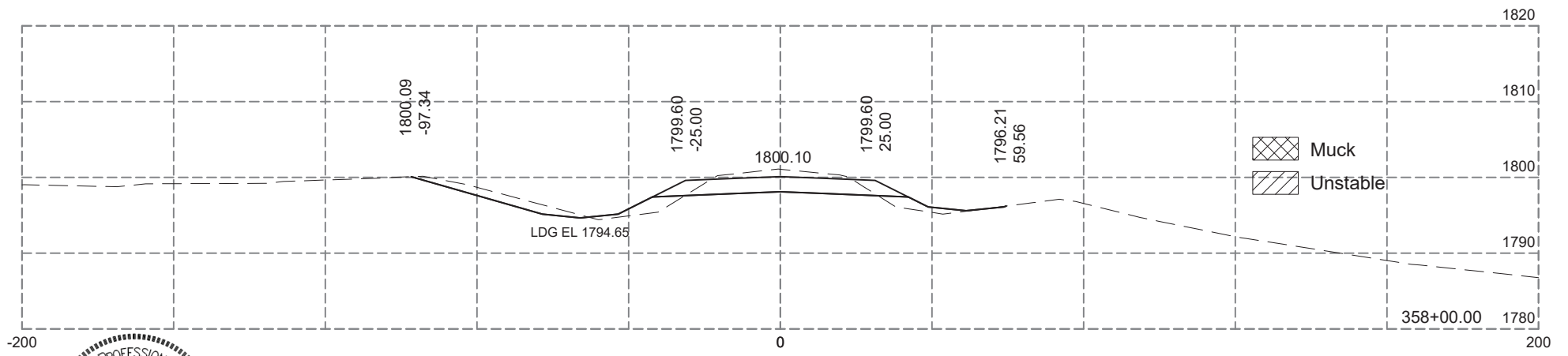
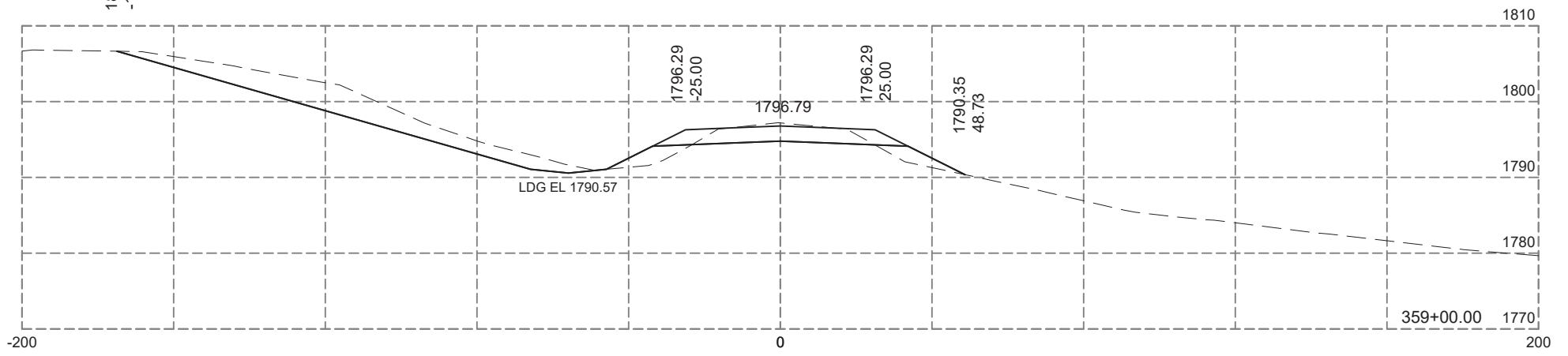
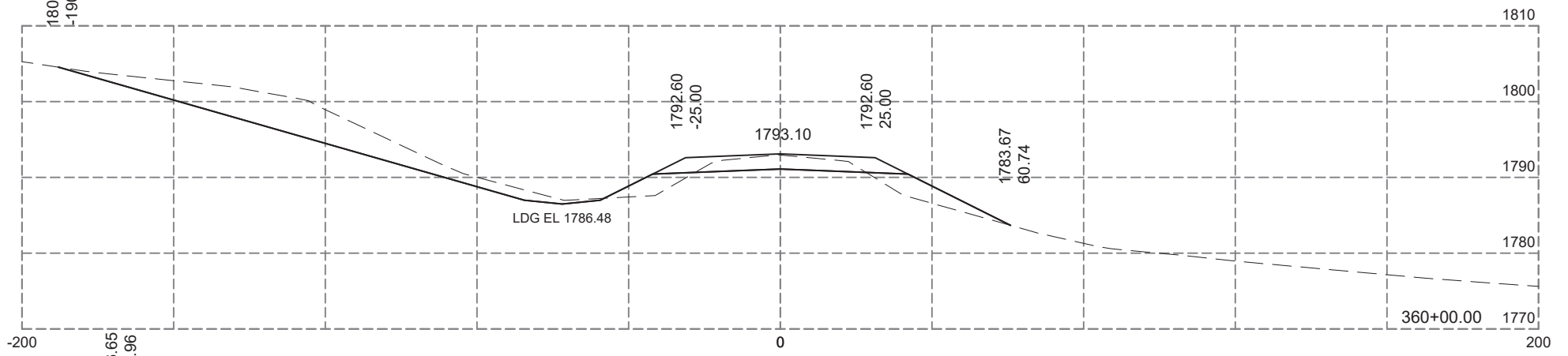
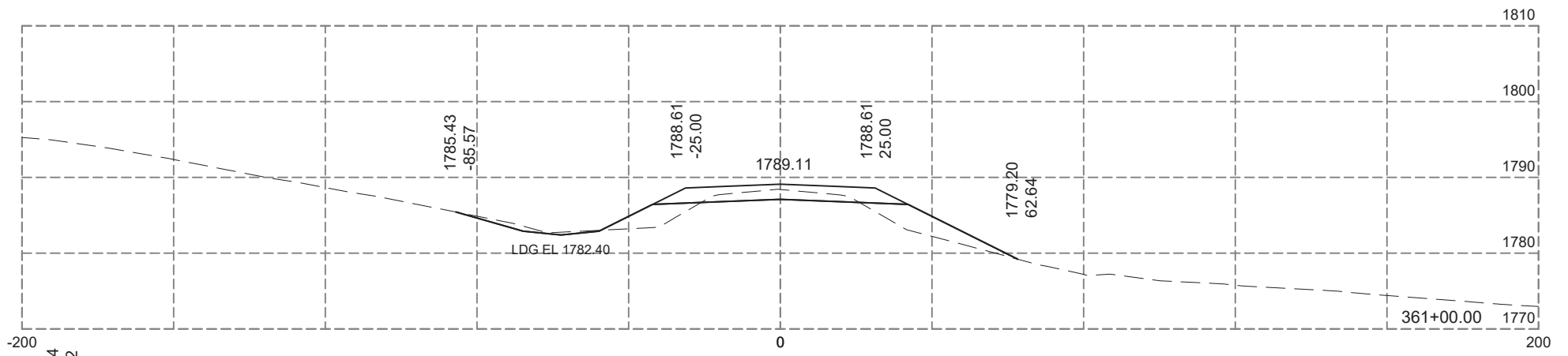
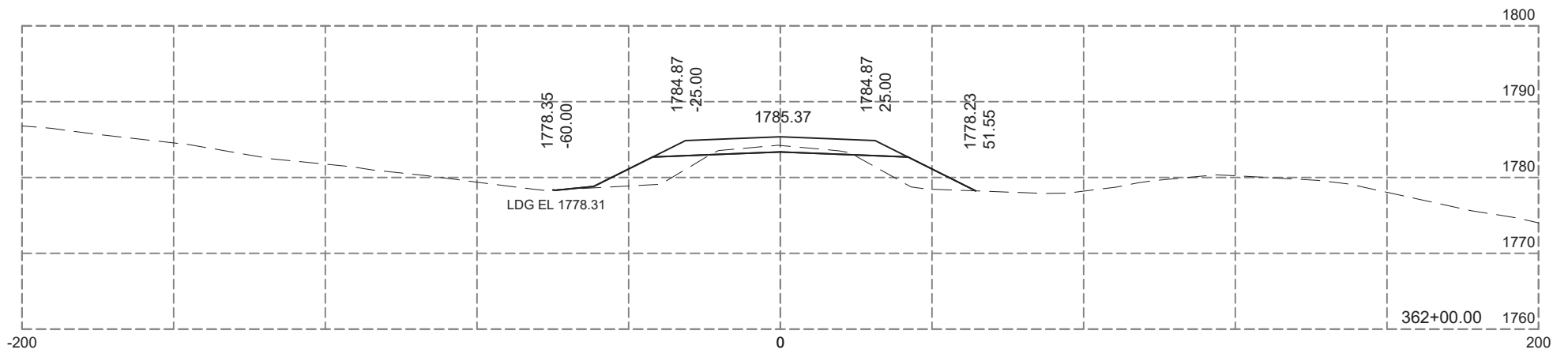
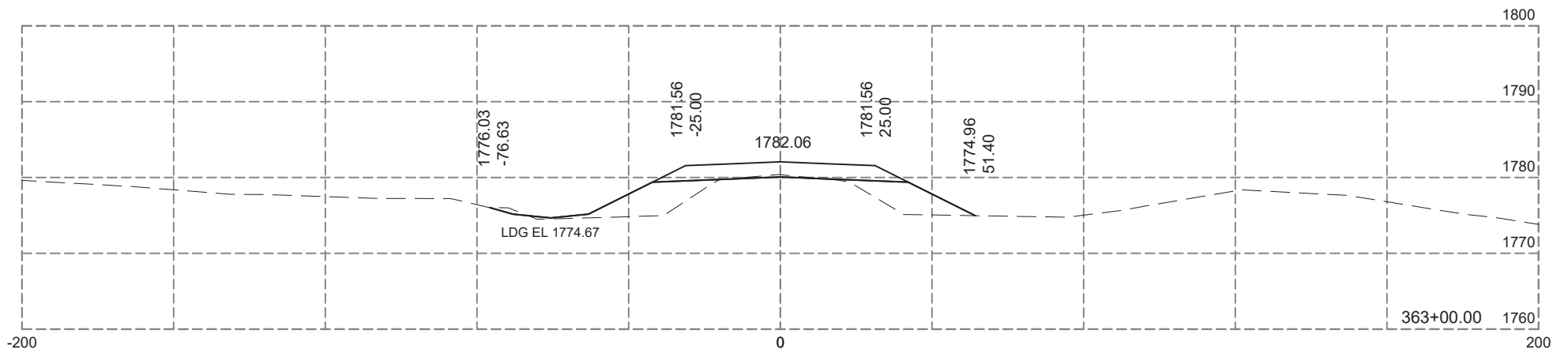

Plotting Date: 12-04-2024

STATE OF SOUTH DAKOTA	PROJECT P-PH-PT 0025(81)158	SHEET X34	TOTAL SHEETS X99
-----------------------	--------------------------------	--------------	---------------------

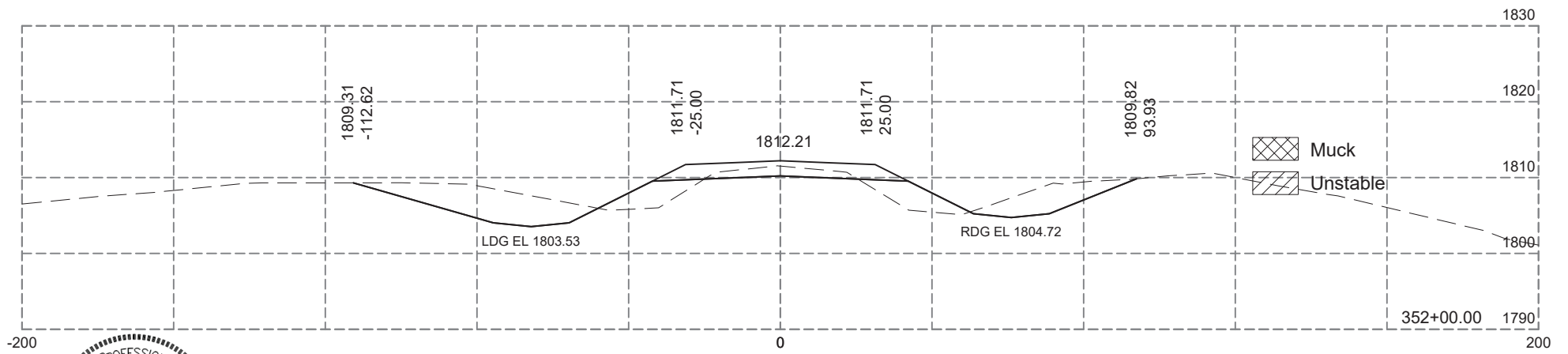
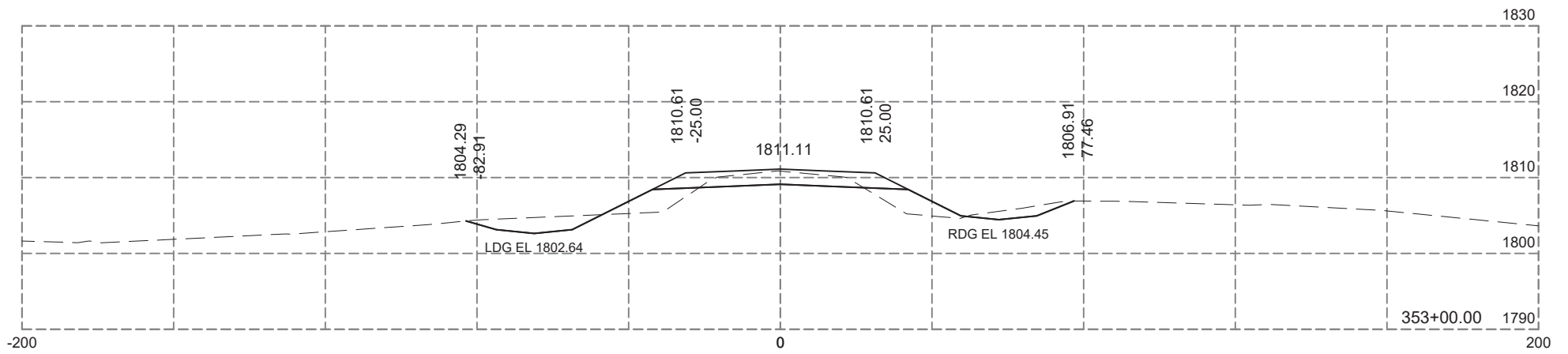
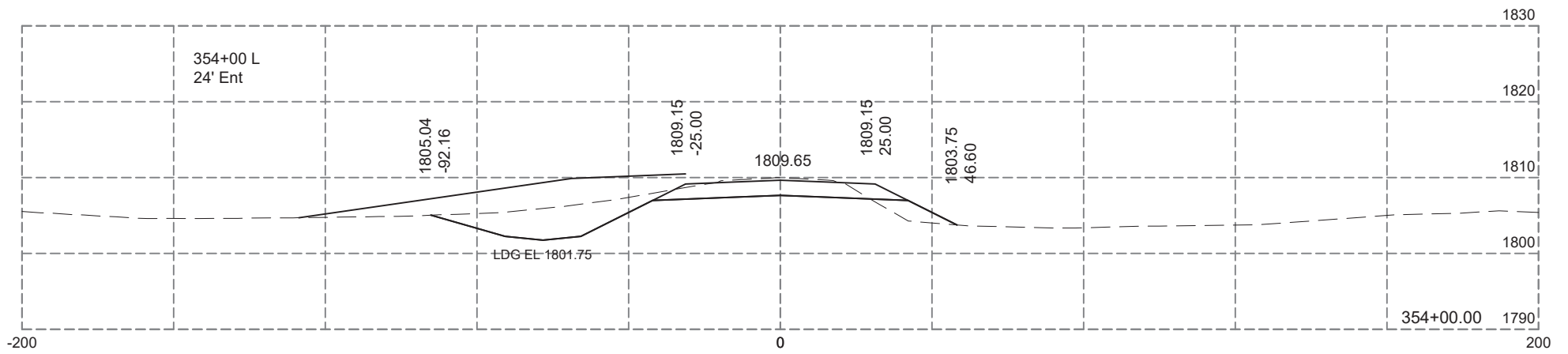
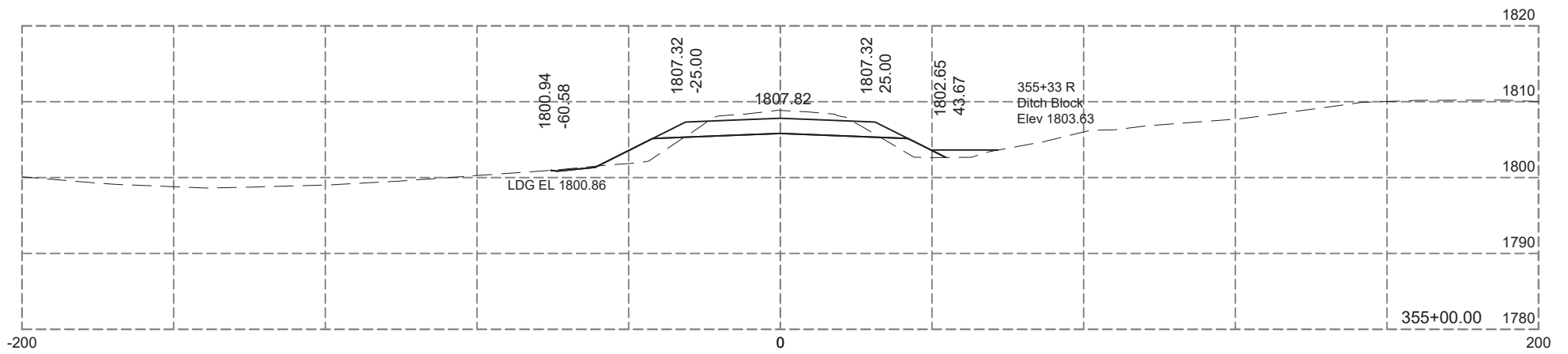
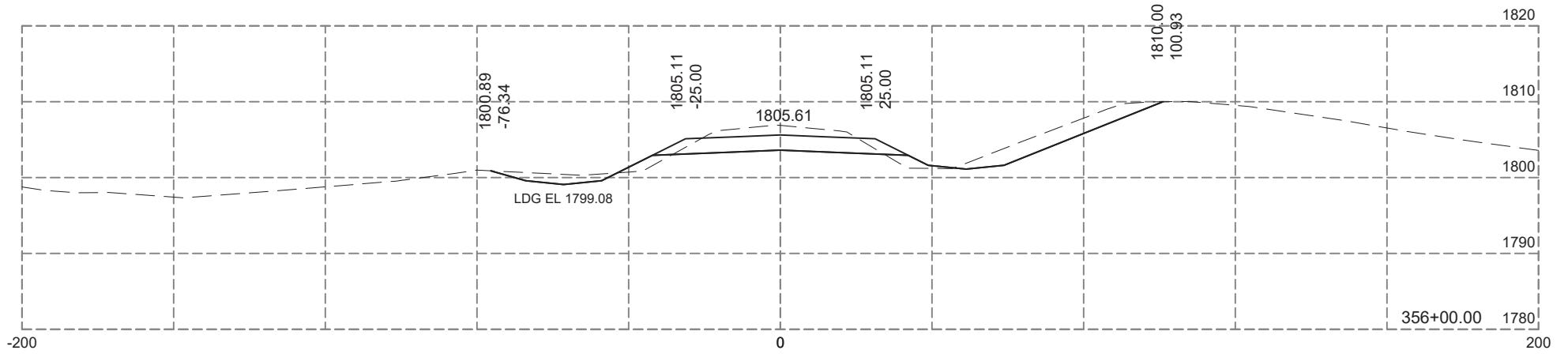
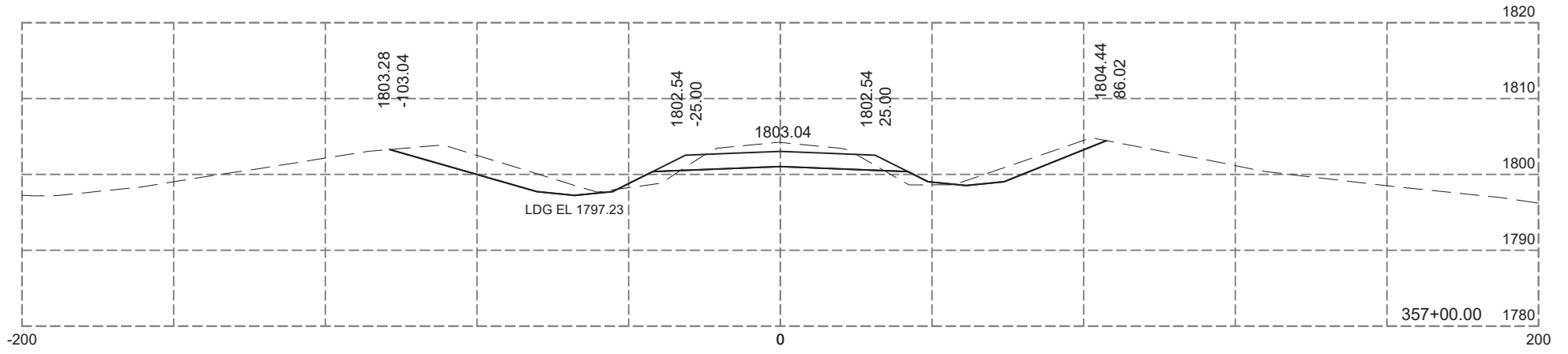

Plotting Date: 12-04-2024

STATE OF SOUTH DAKOTA	PROJECT	SHEET	TOTAL SHEETS
	P-PH-PT 0025(81)158	X35	X99

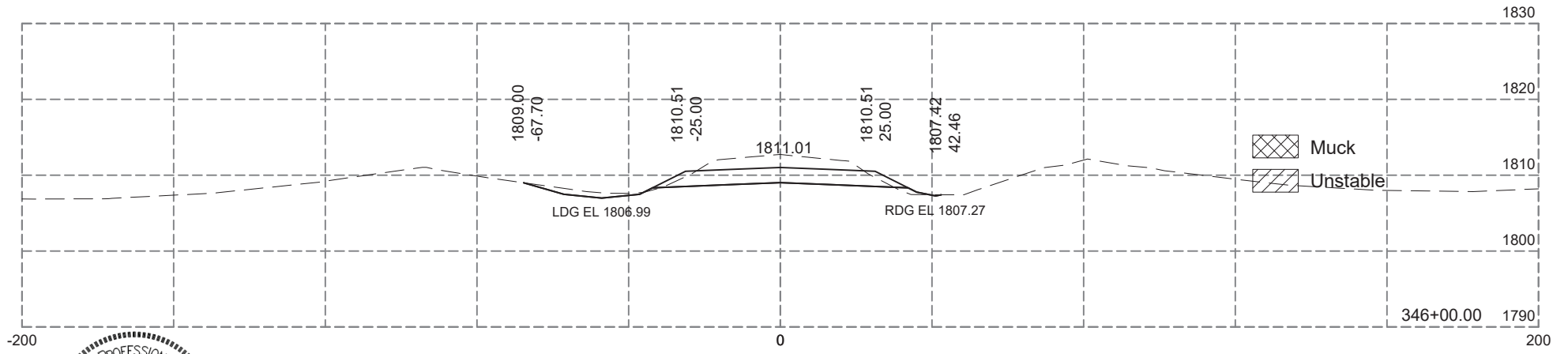
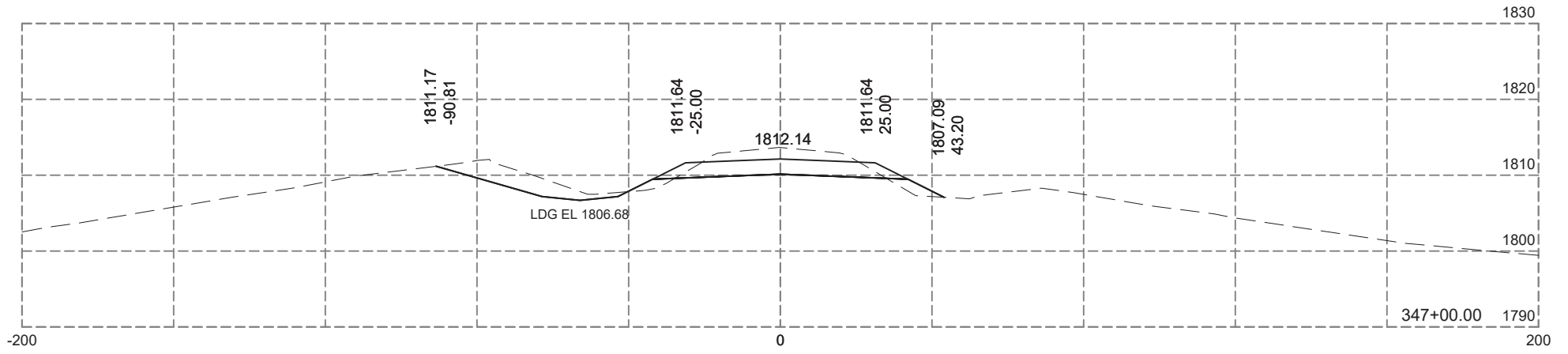
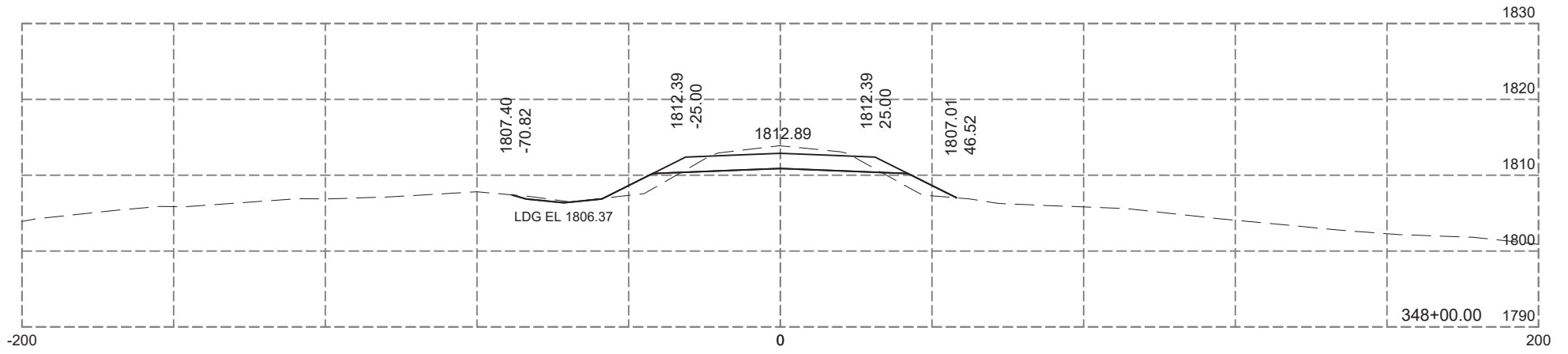
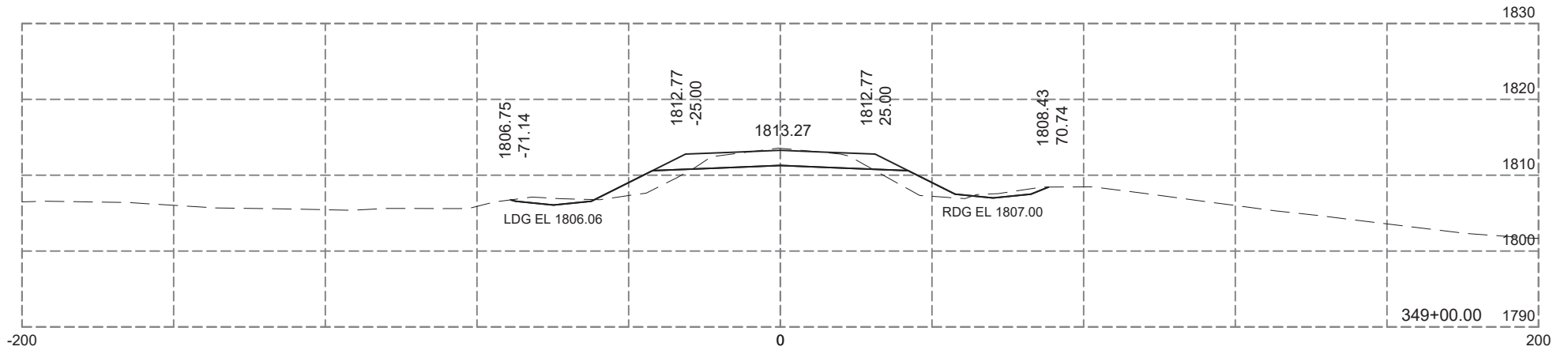
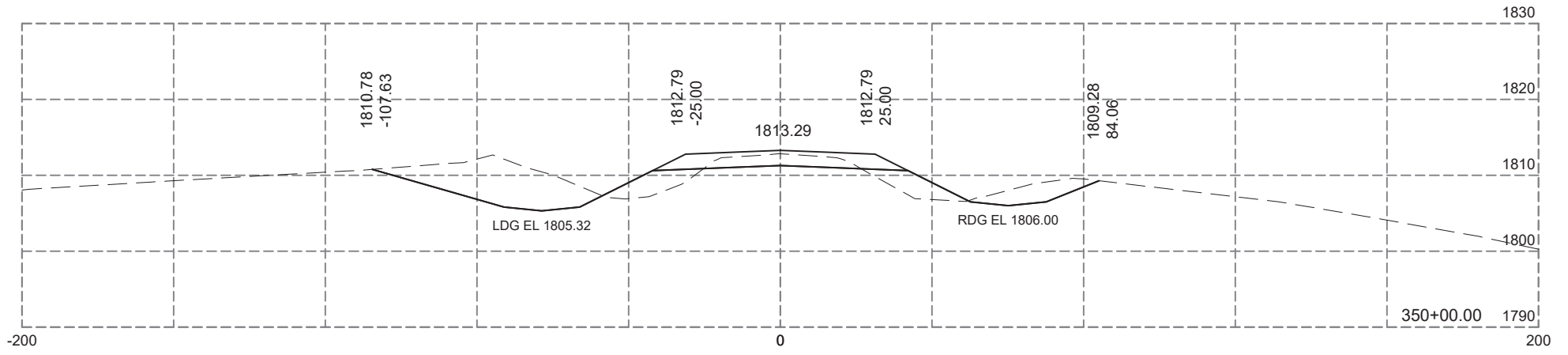
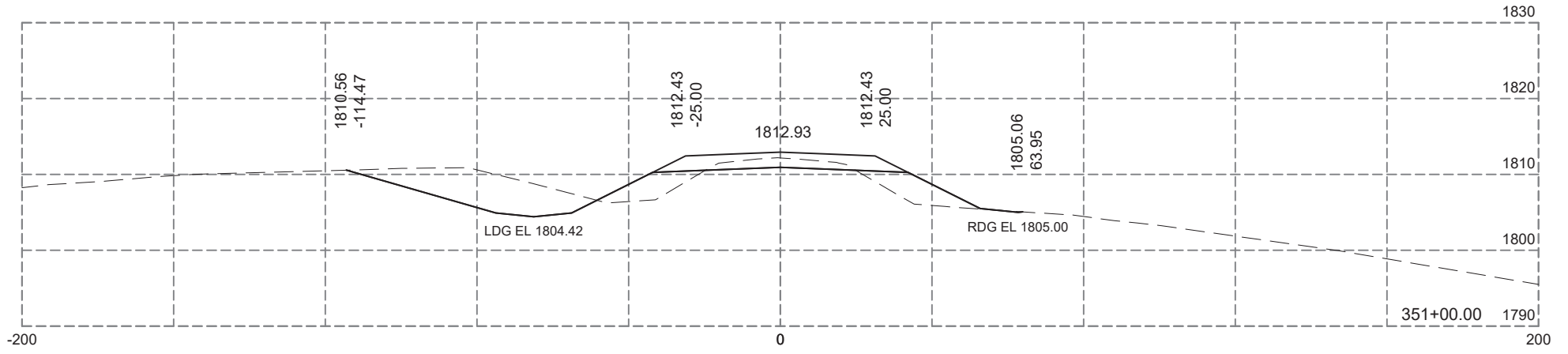

Plotting Date: 12-04-2024

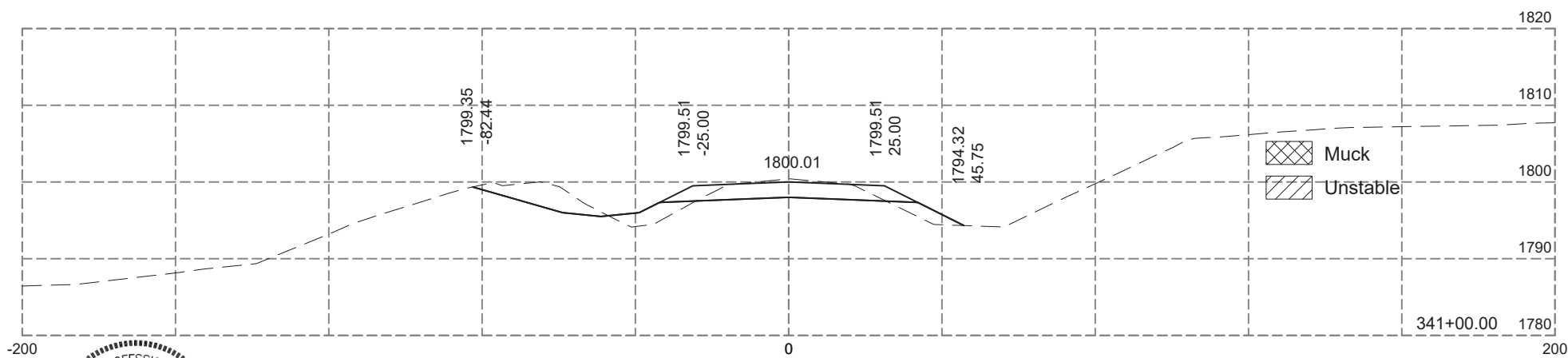
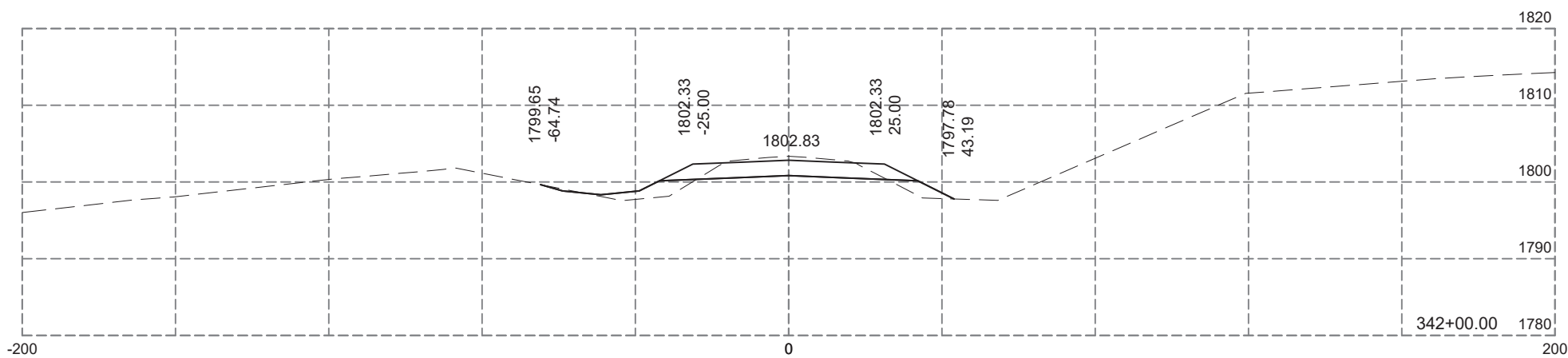
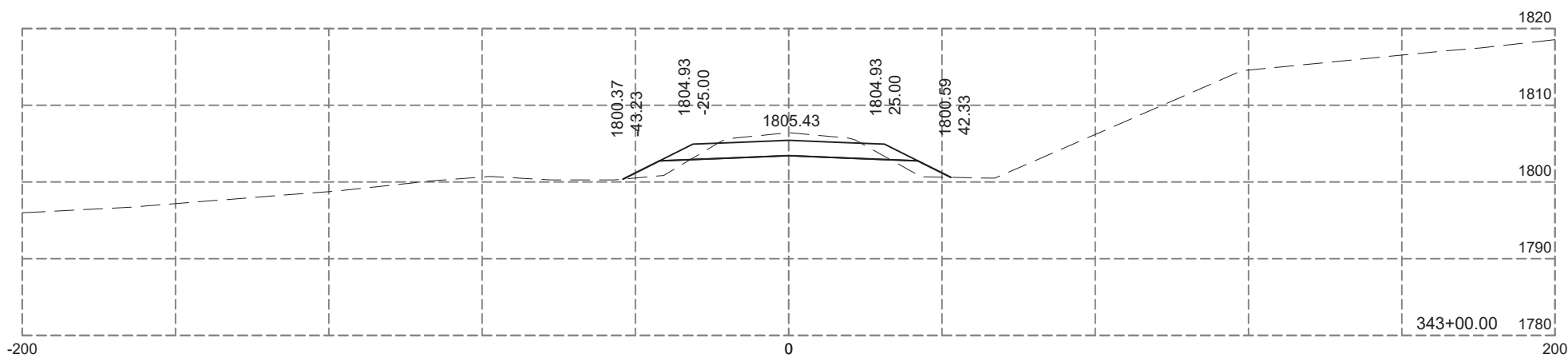
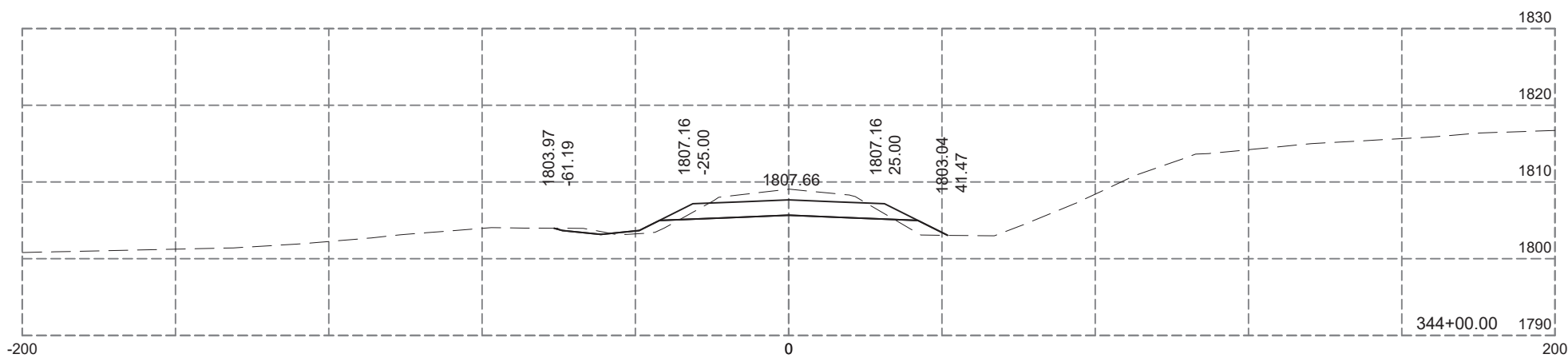
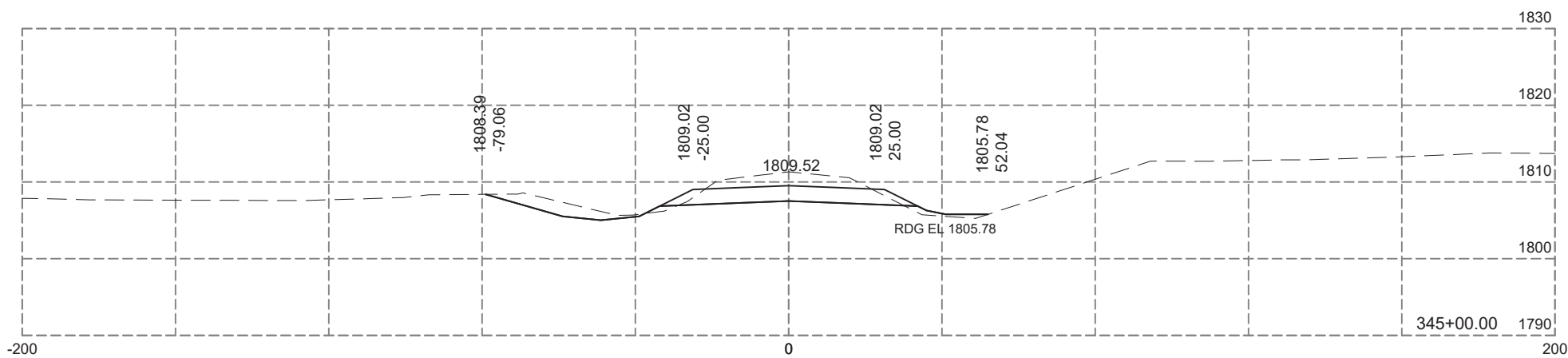
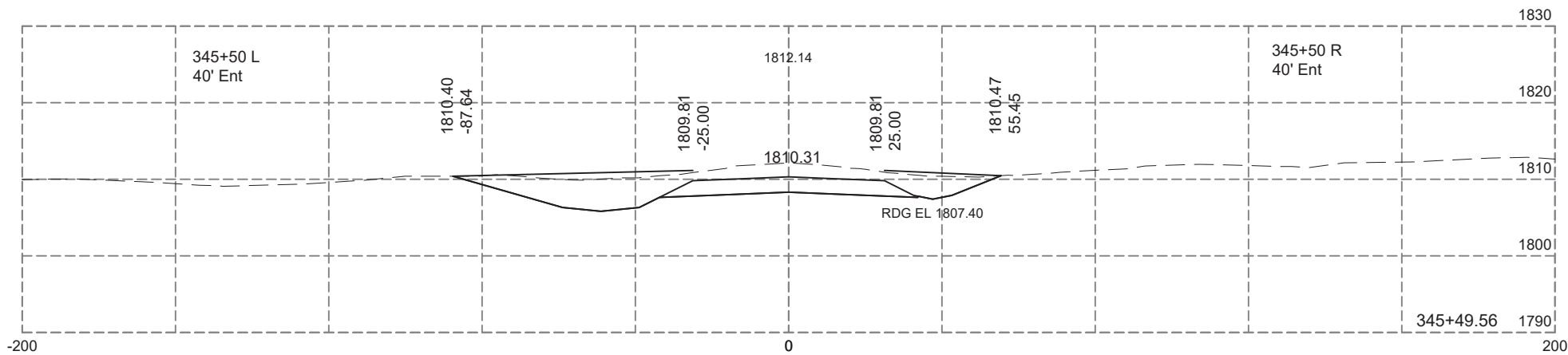

STATE OF SOUTH DAKOTA	PROJECT	SHEET	TOTAL SHEETS
	P-PH-PT 0025(81)158	X36	X99

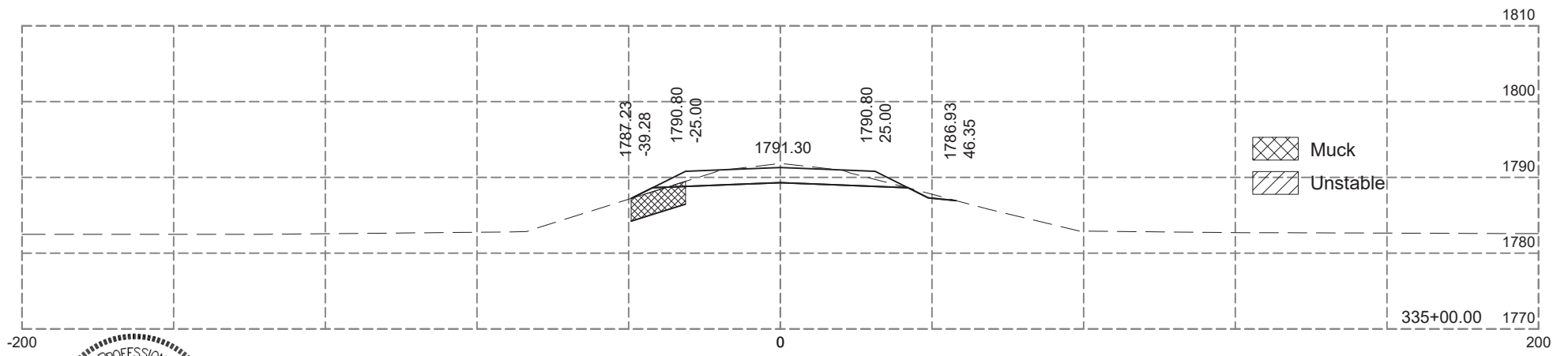
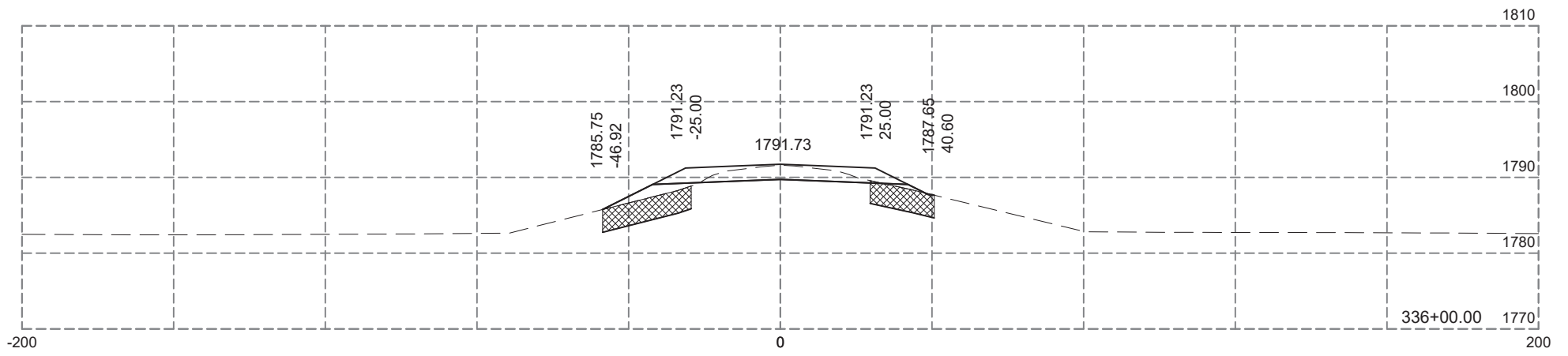
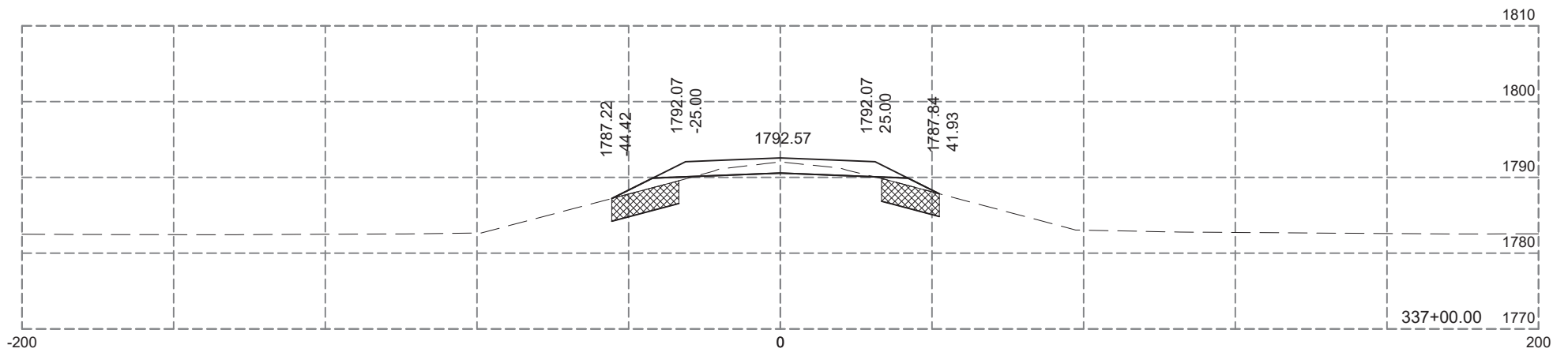
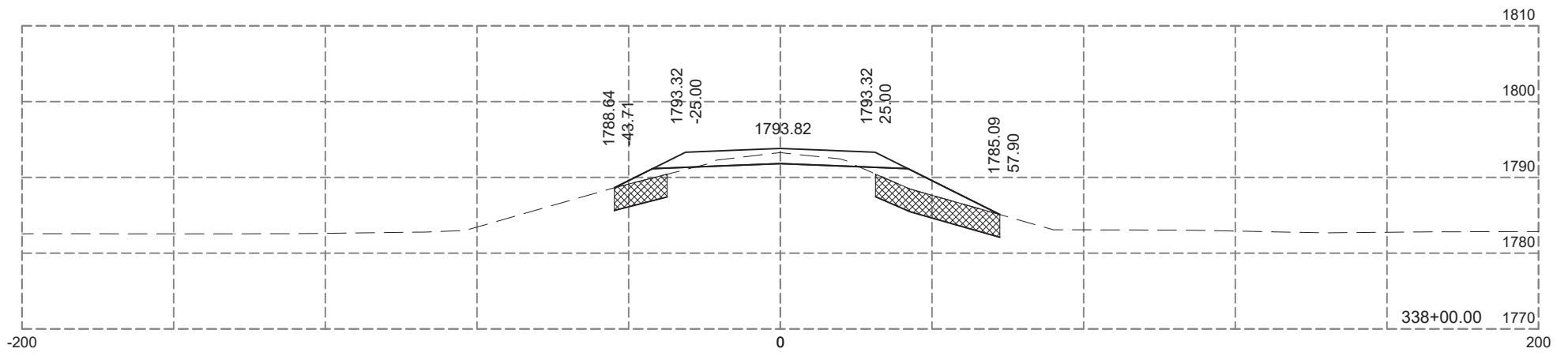
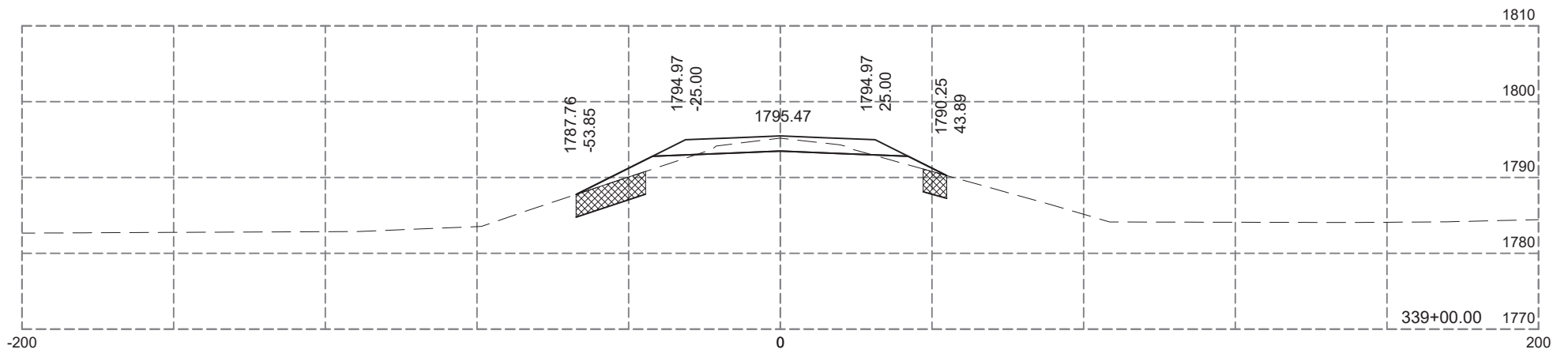
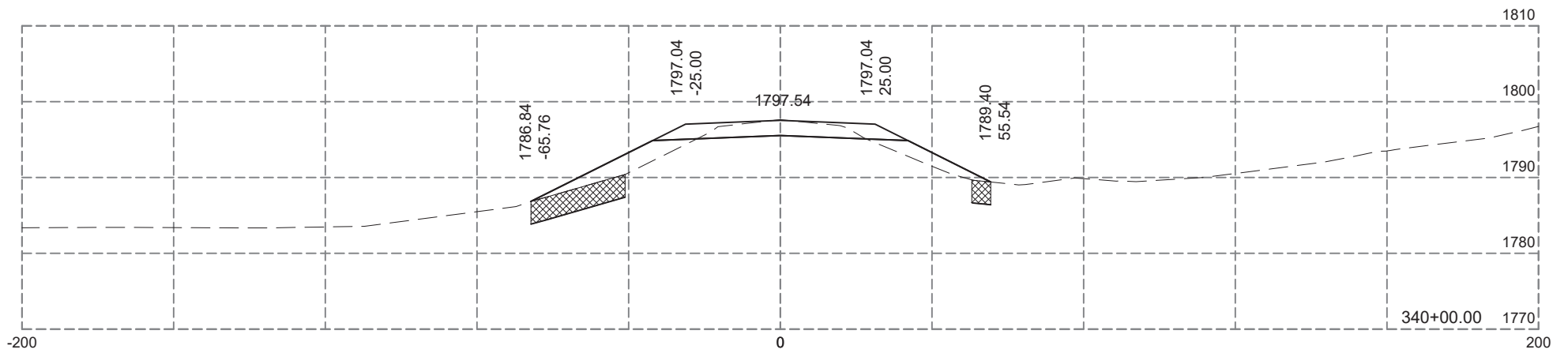

Plotting Date: 12-04-2024

STATE OF SOUTH DAKOTA	PROJECT P-PH-PT 0025(81)158	SHEET X37	TOTAL SHEETS X99
-----------------------	--------------------------------	--------------	---------------------



 Muck  
 Unstable



Plotting Date: 12-04-2024

STATE OF SOUTH DAKOTA	PROJECT	SHEET	TOTAL SHEETS
	P-PH-PT 0025(81)158	X38	X99

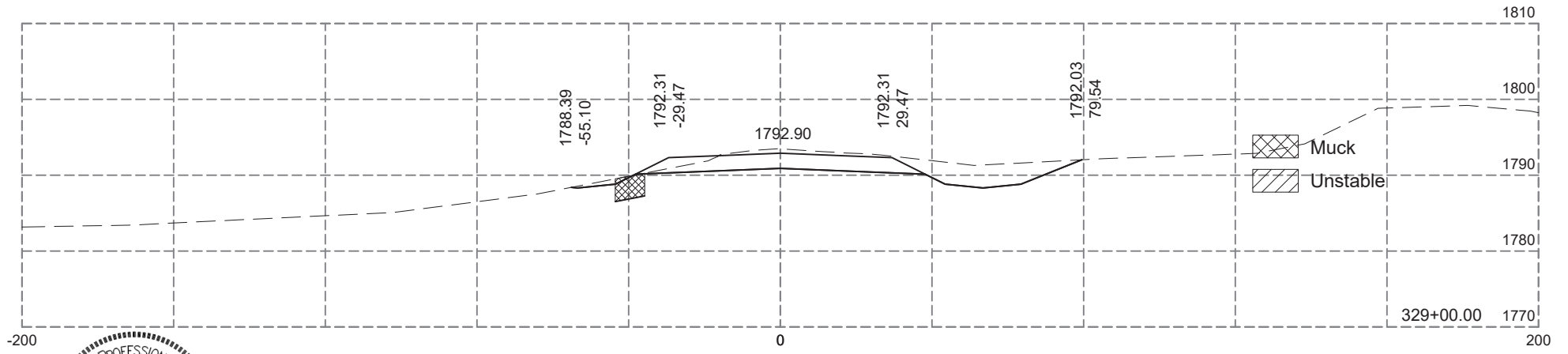
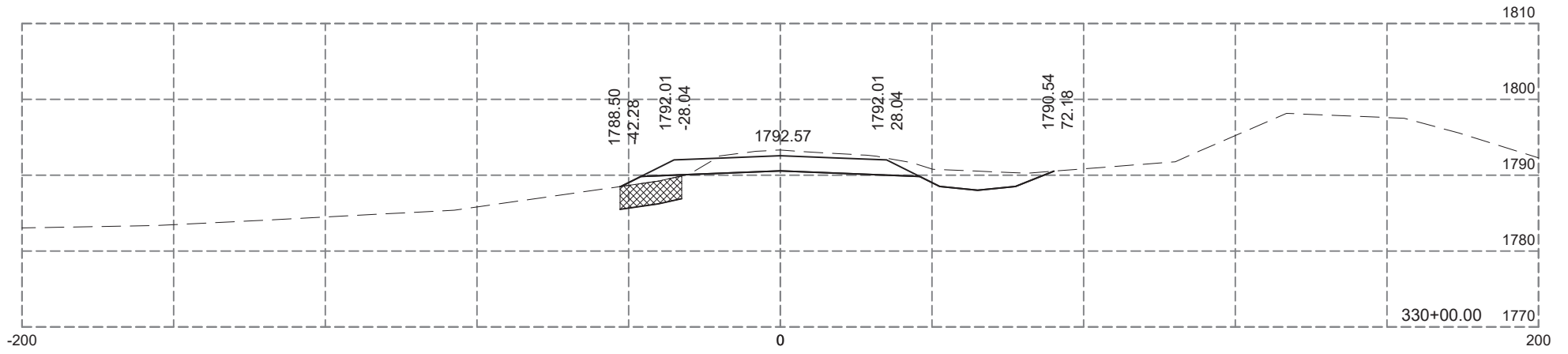
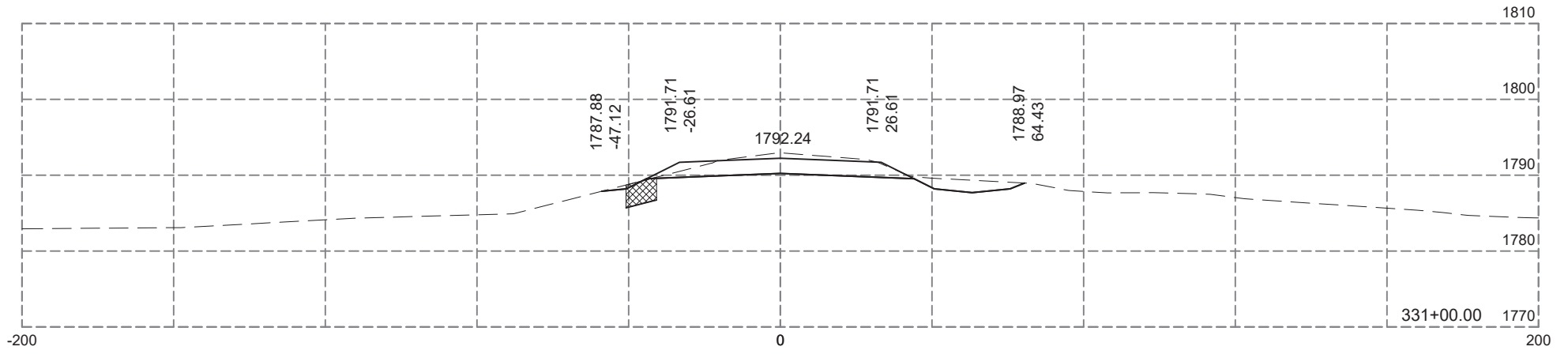
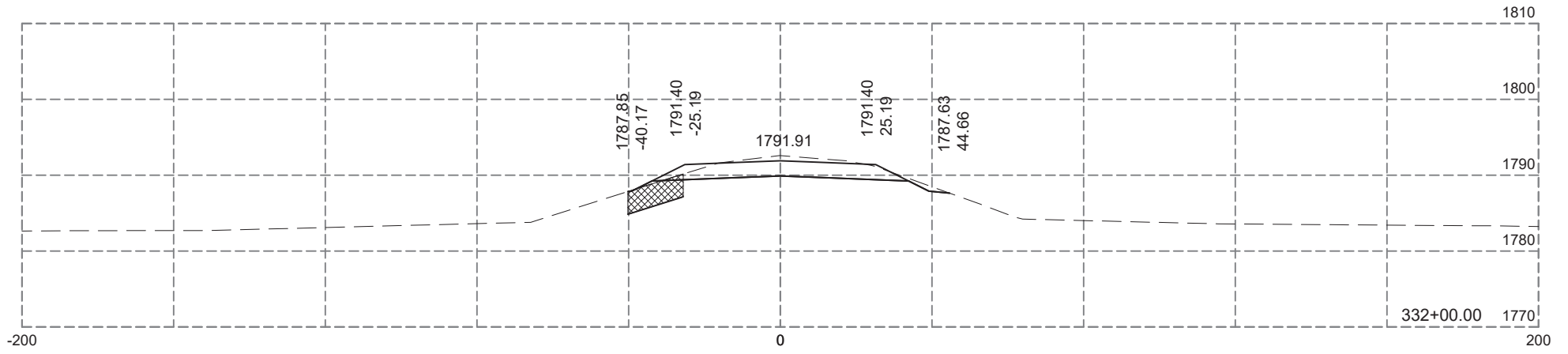
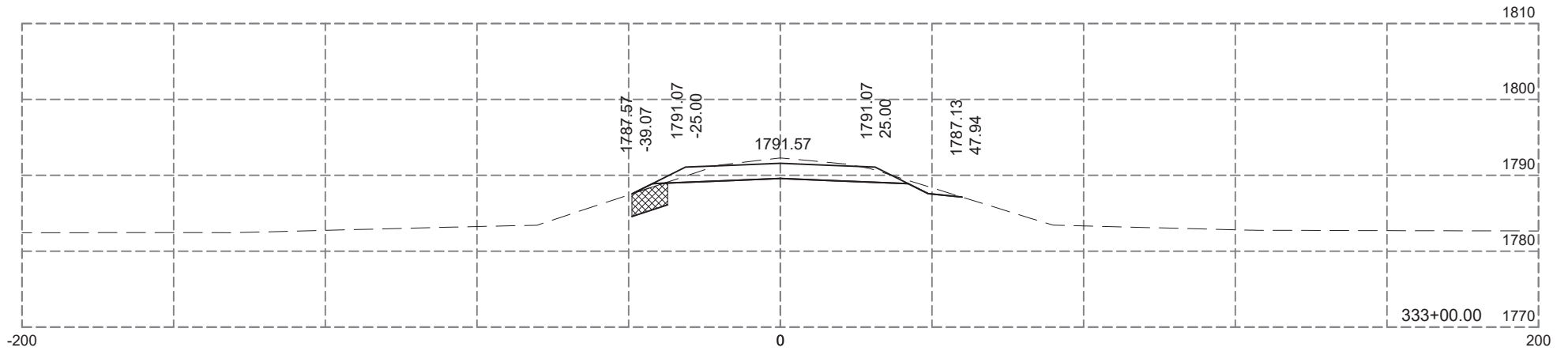
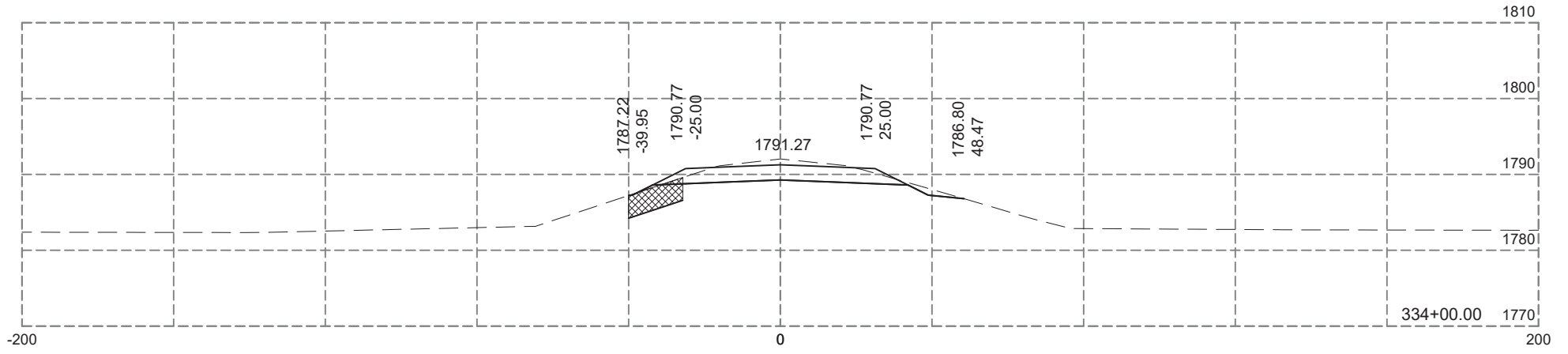

Plotting Date: 12-04-2024

STATE OF SOUTH DAKOTA	PROJECT P-PH-PT 0025(81)158	SHEET X39	TOTAL SHEETS X99
-----------------------	--------------------------------	--------------	---------------------

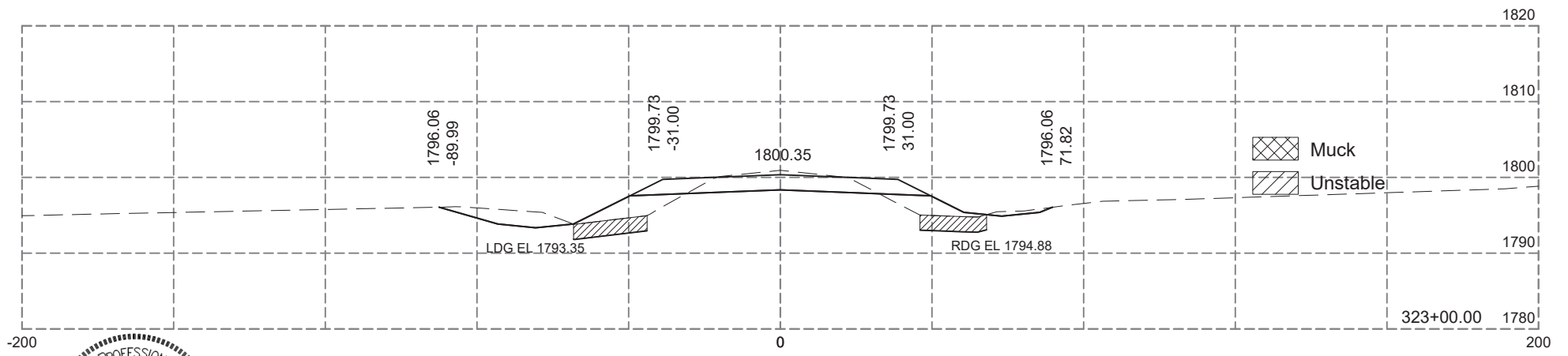
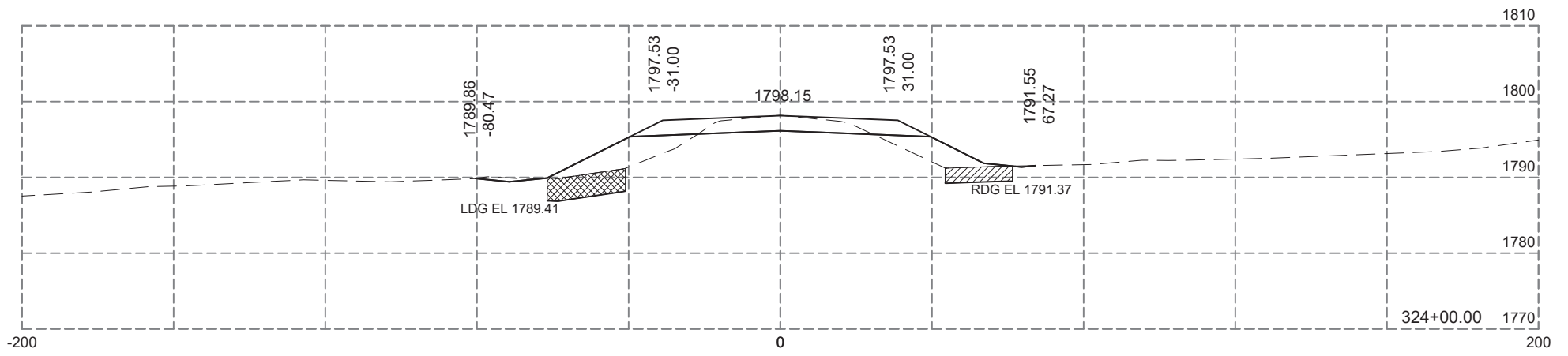
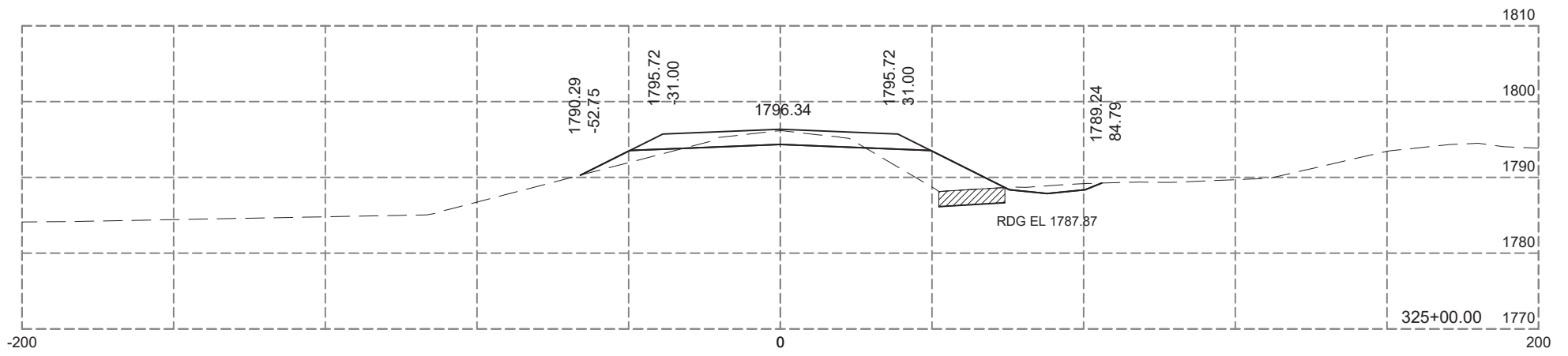
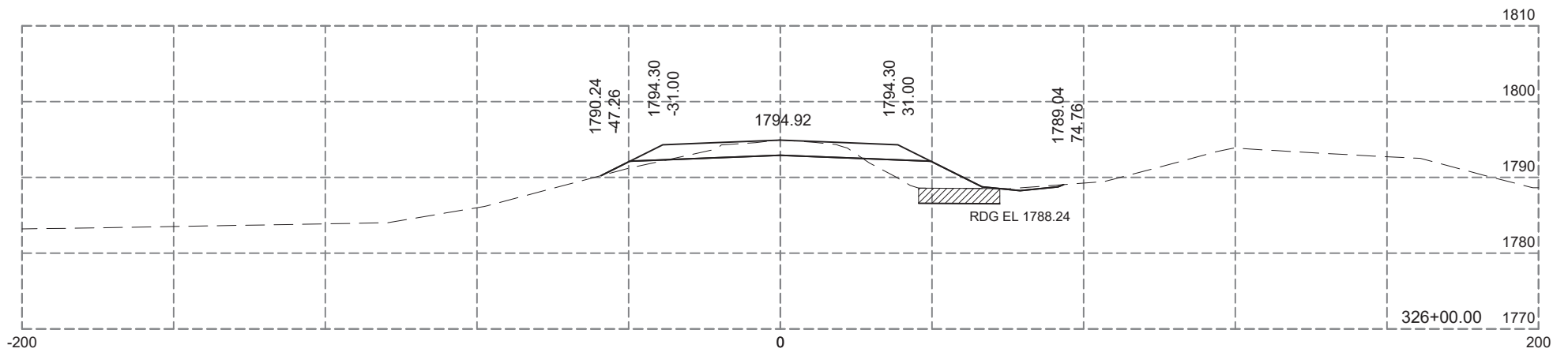
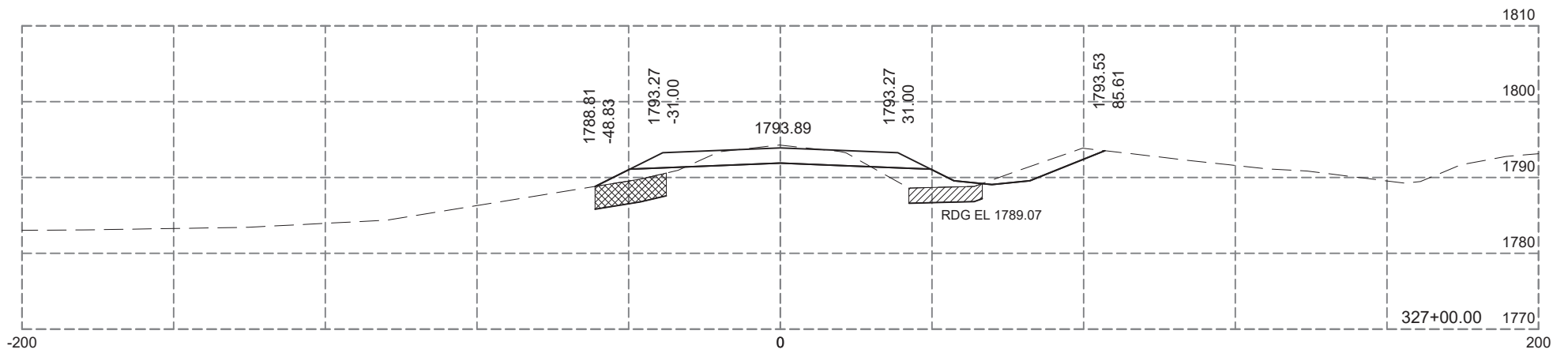
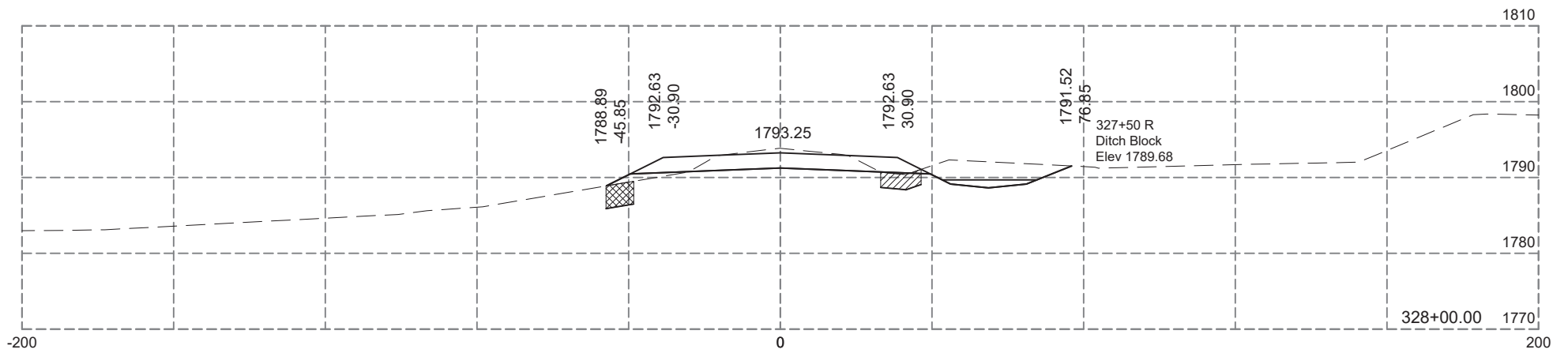

Plotting Date: 12-04-2024

STATE OF SOUTH DAKOTA	PROJECT P-PH-PT 0025(81)158	SHEET X40	TOTAL SHEETS X99
-----------------------	--------------------------------	--------------	---------------------



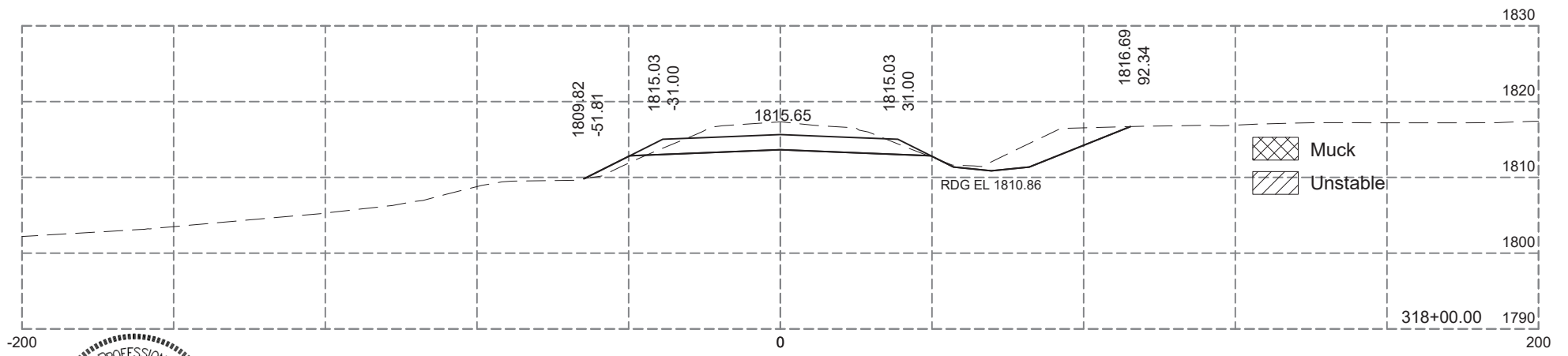
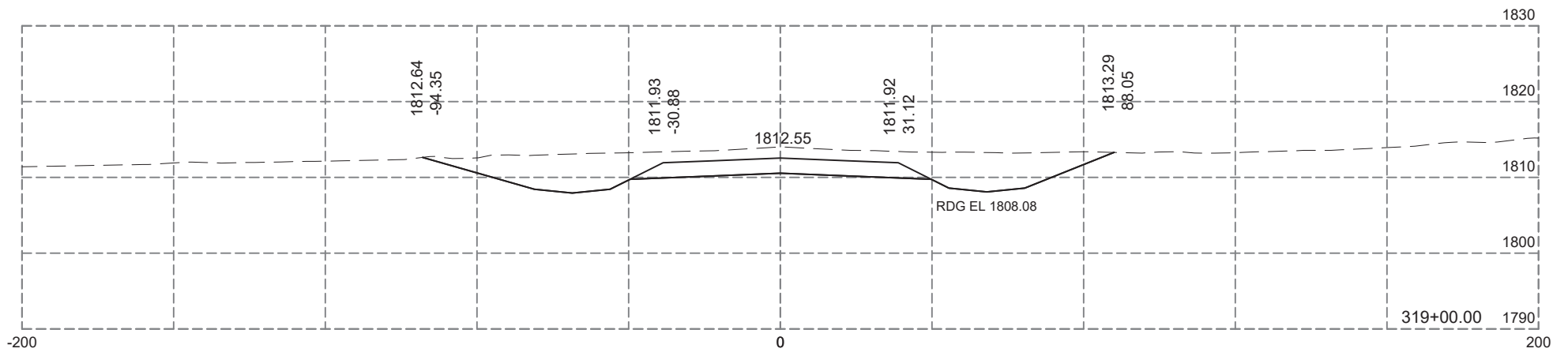
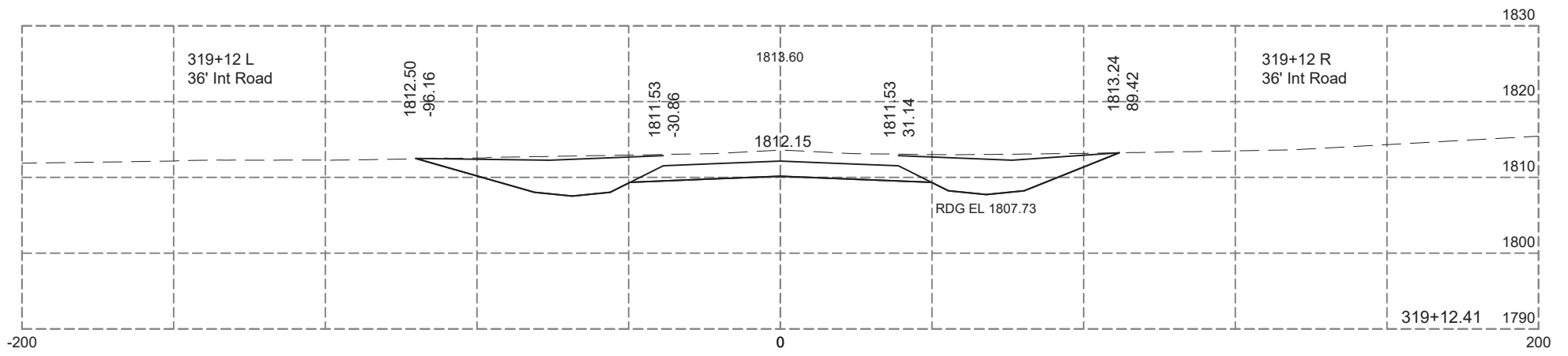
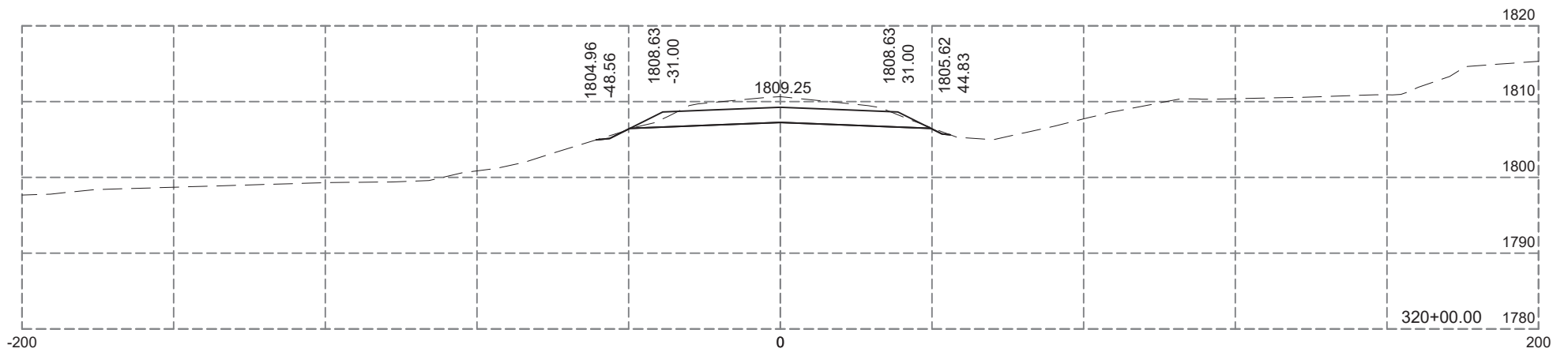
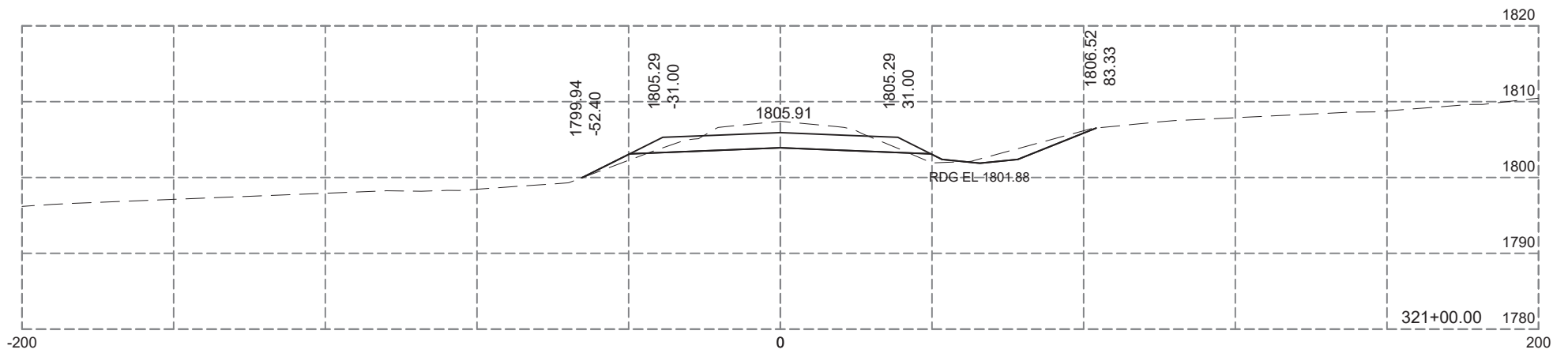
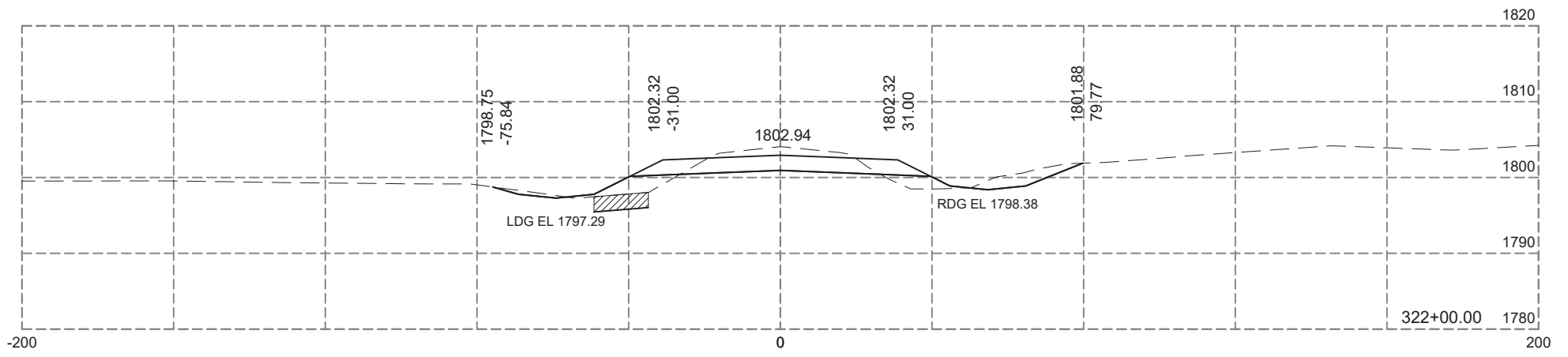

Muck  
 Unstable



Plotting Date: 12-04-2024

STATE OF SOUTH DAKOTA	PROJECT P-PH-PT 0025(81)158	SHEET X41	TOTAL SHEETS X99
-----------------------	--------------------------------	--------------	---------------------

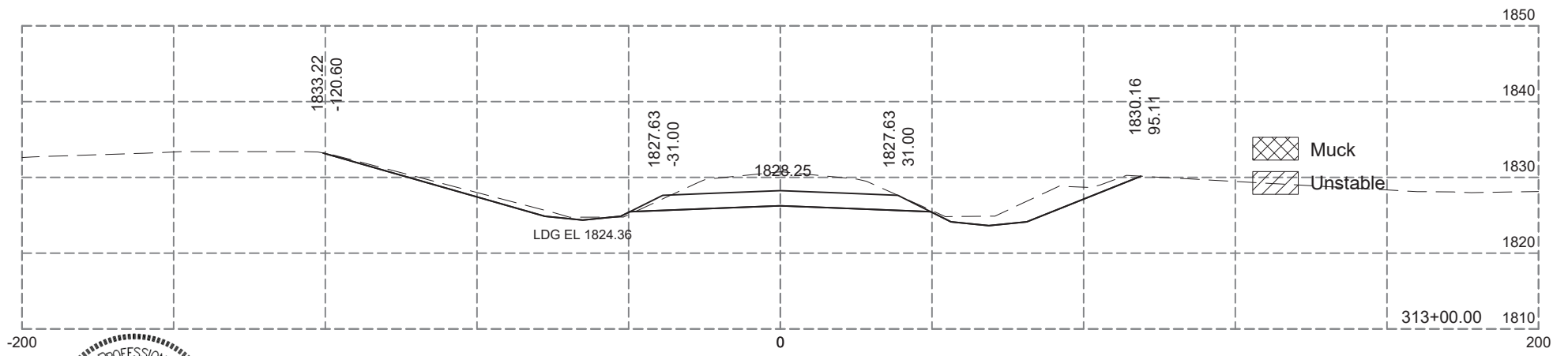
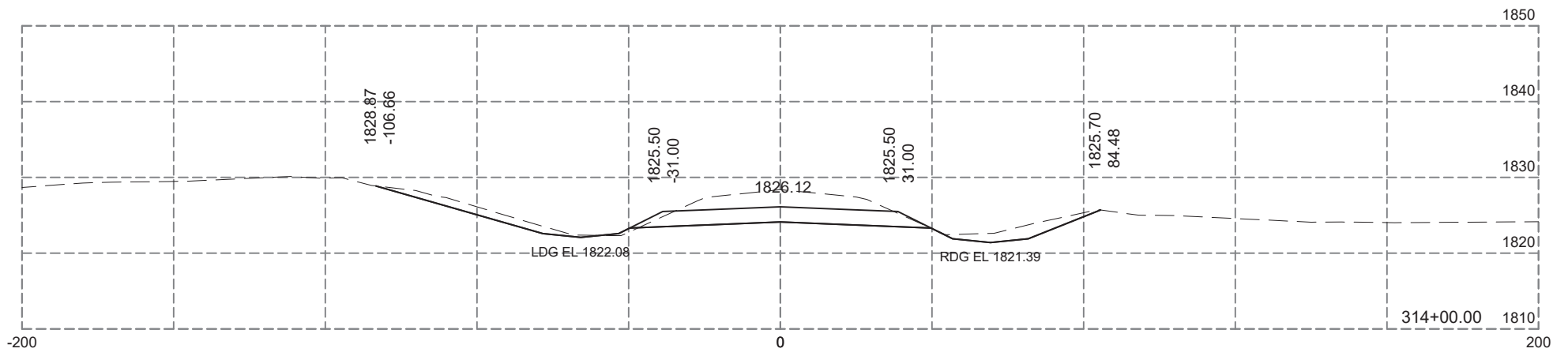
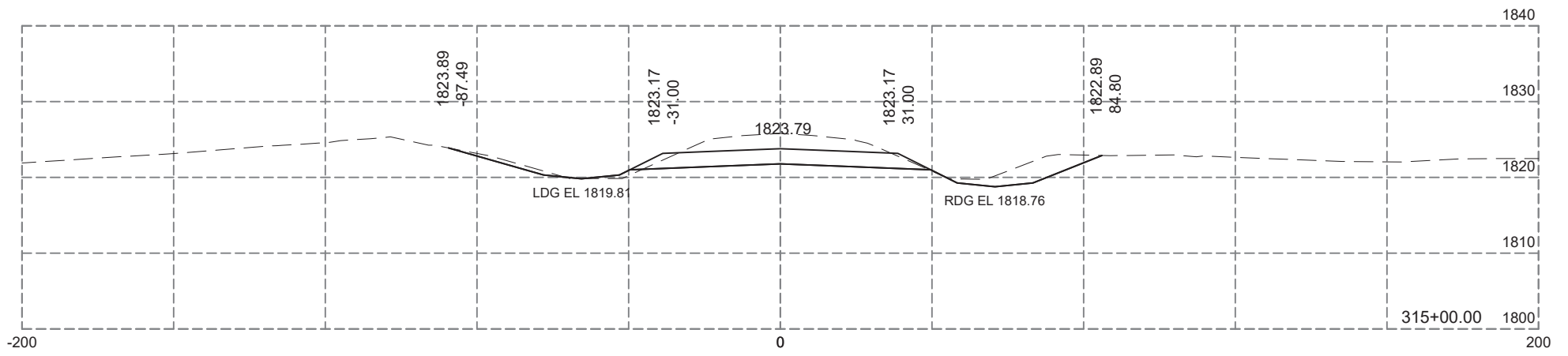
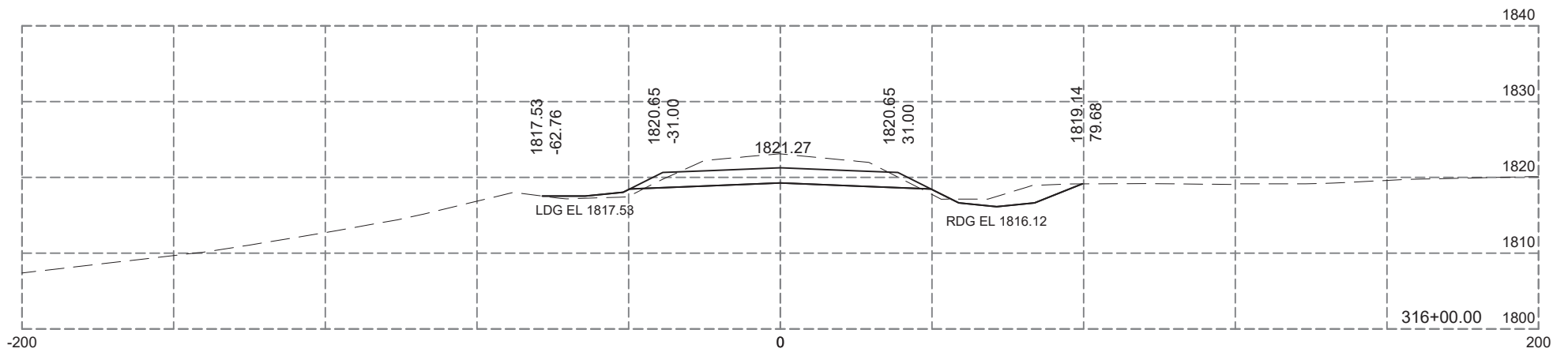
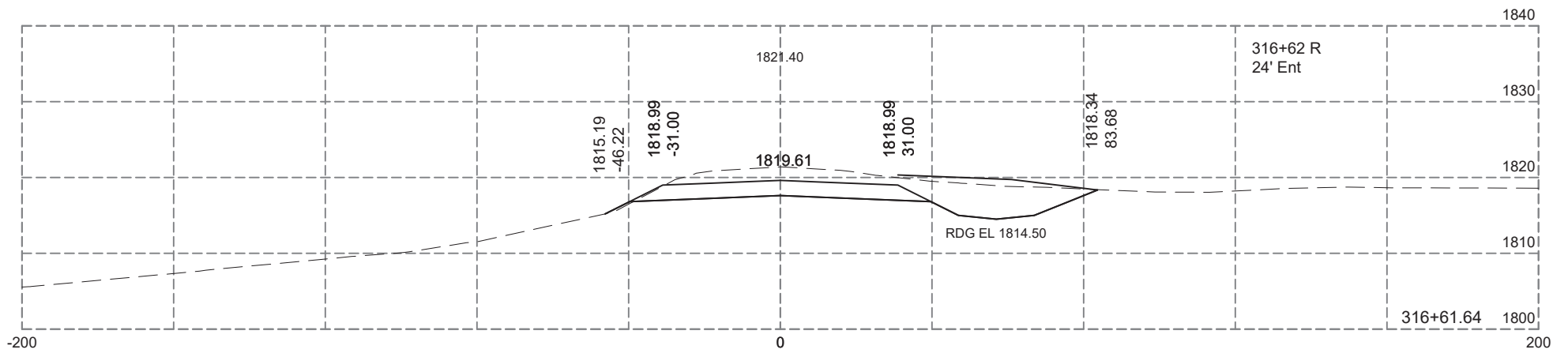
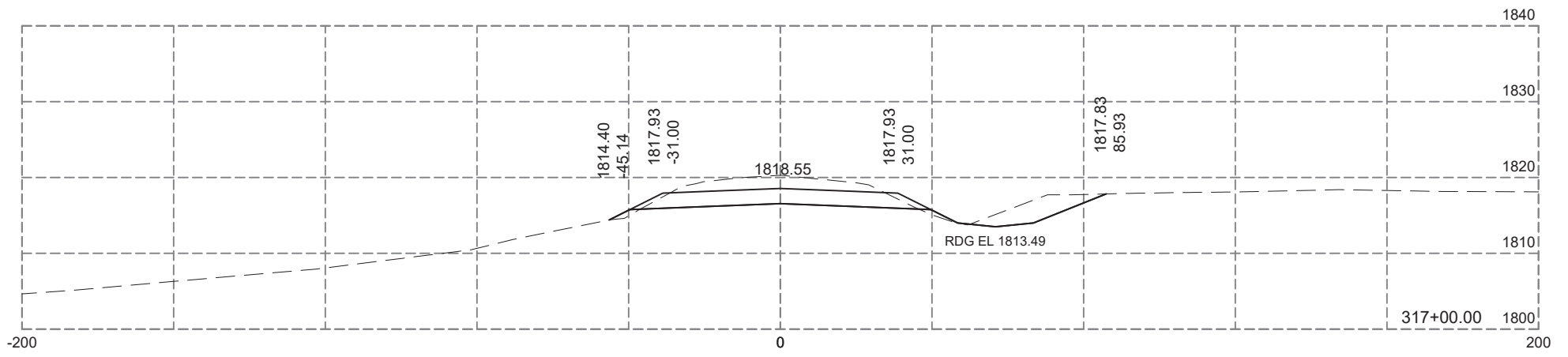

Muck  
 Unstable



Plotting Date: 12-04-2024

STATE OF SOUTH DAKOTA	PROJECT P-PH-PT 0025(81)158	SHEET X42	TOTAL SHEETS X99
-----------------------	--------------------------------	--------------	---------------------

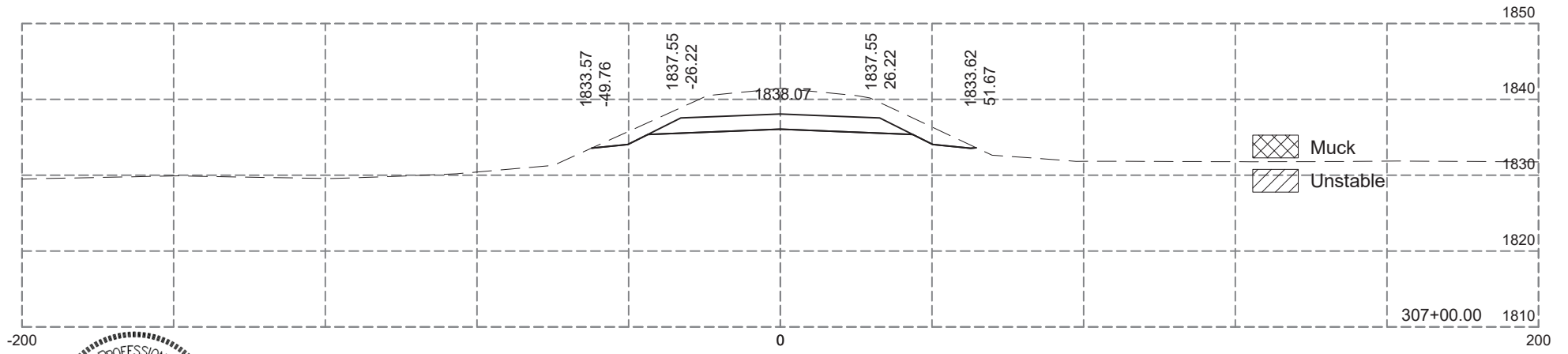
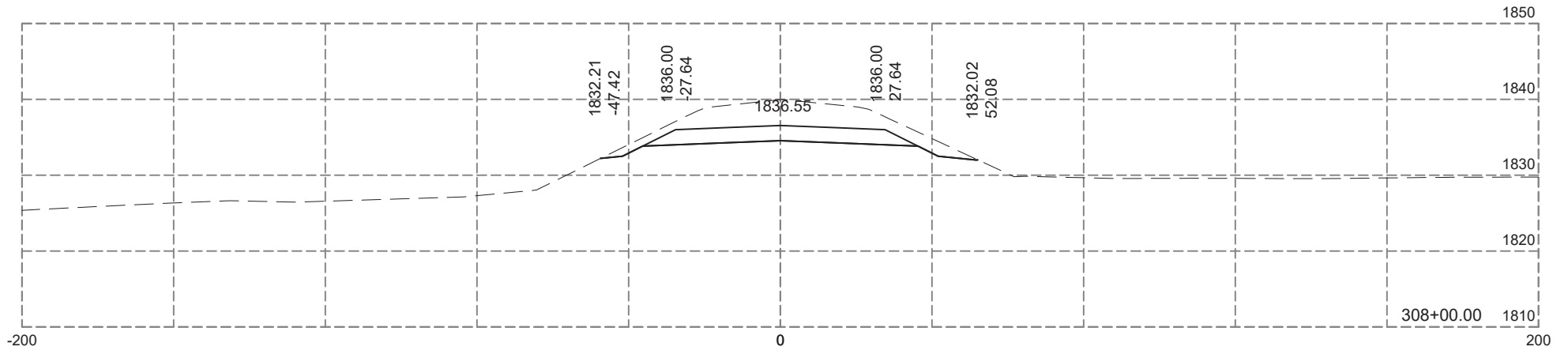
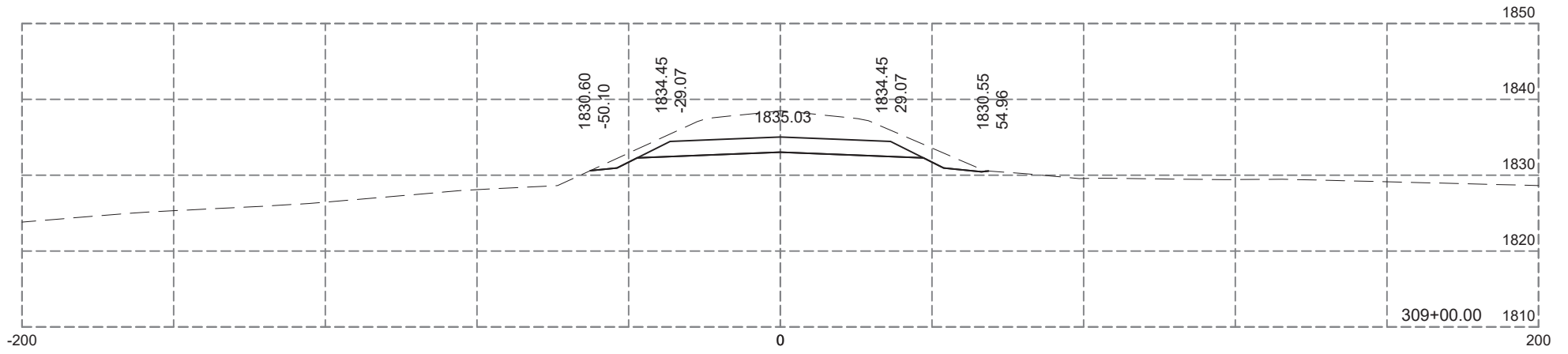
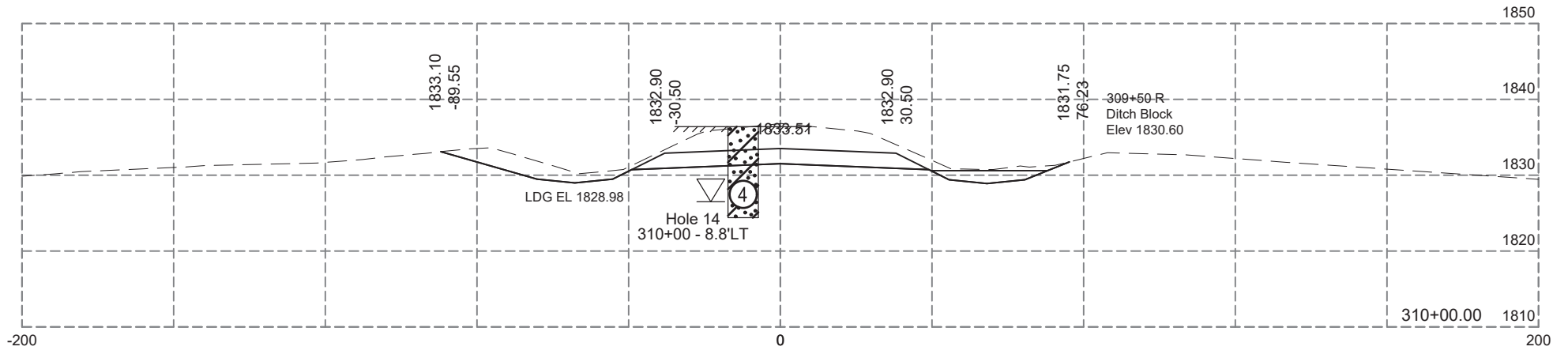
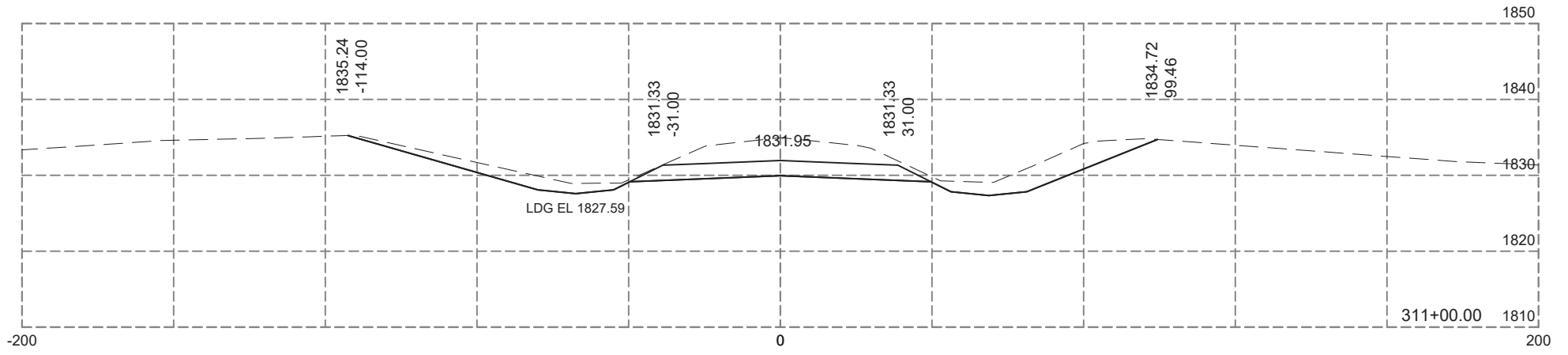
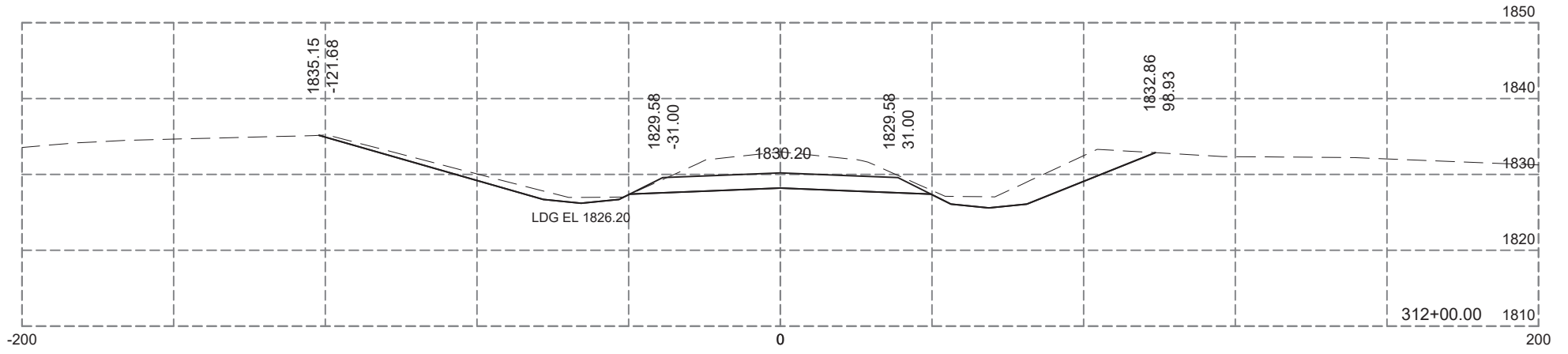

Plotting Date: 12-04-2024

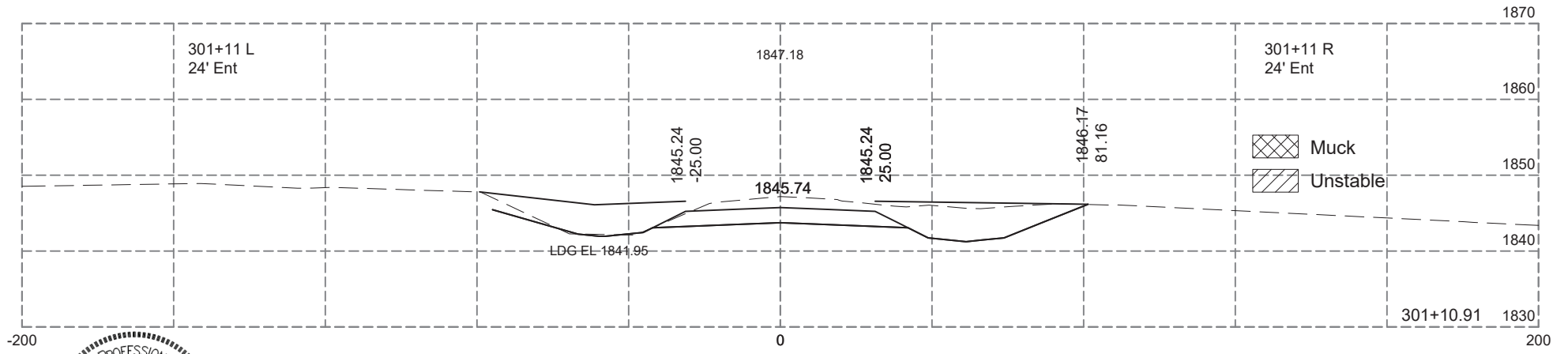
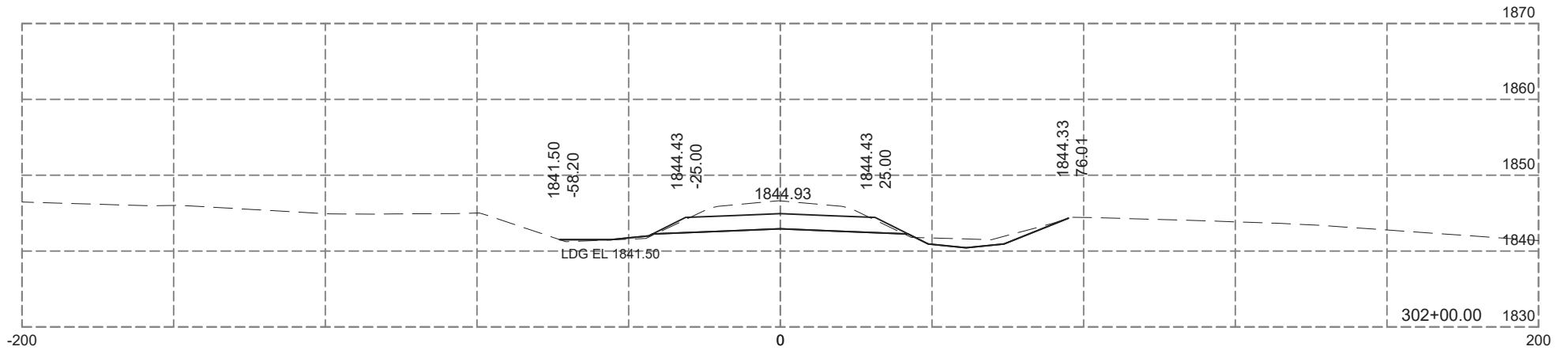
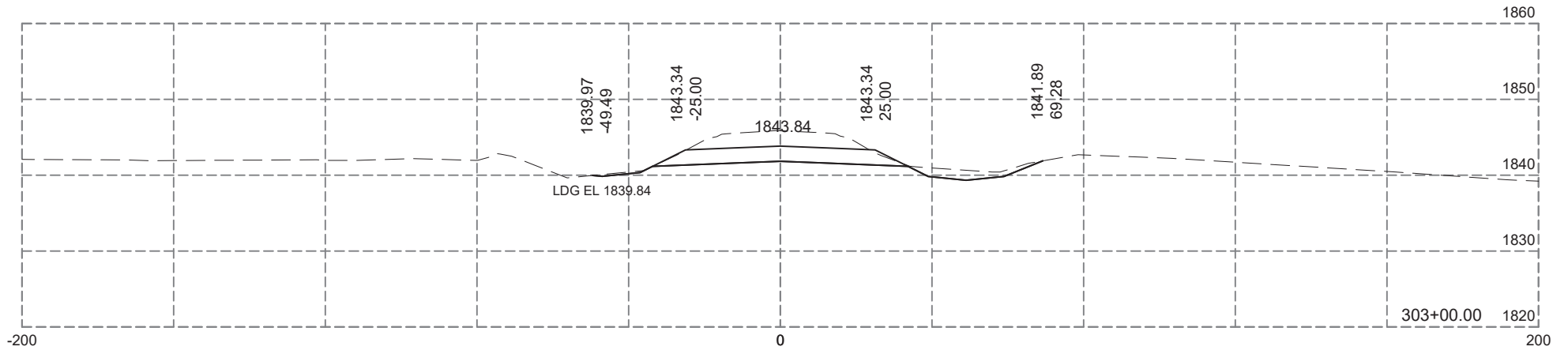
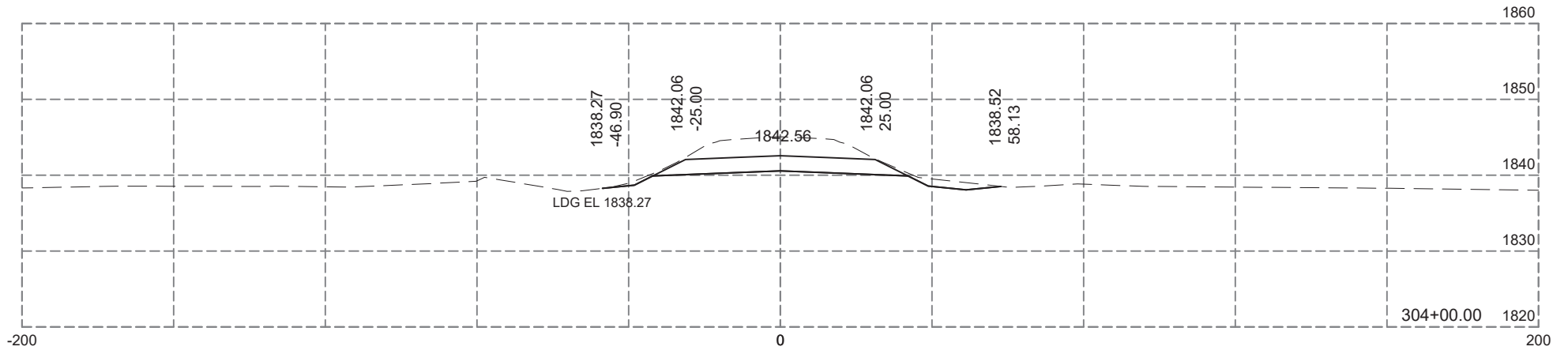
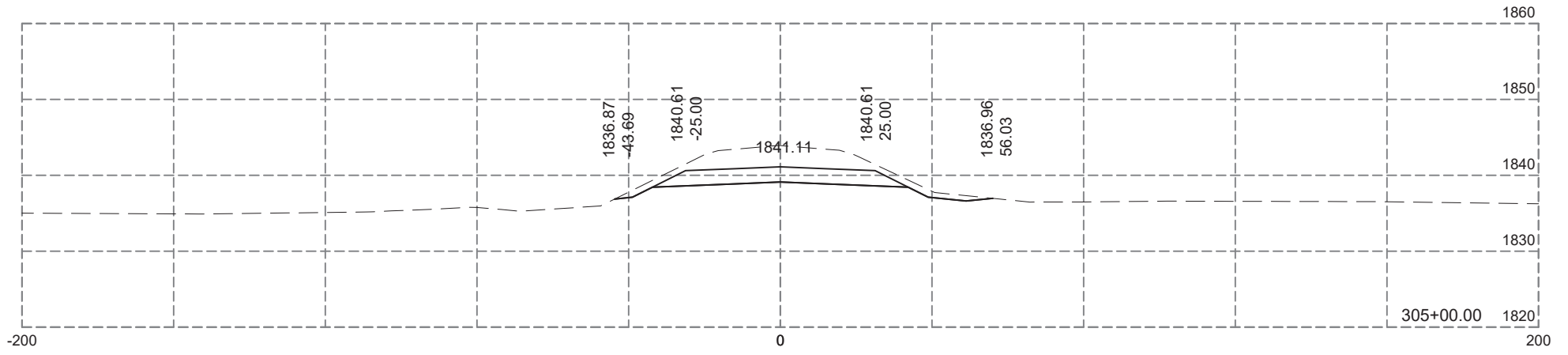
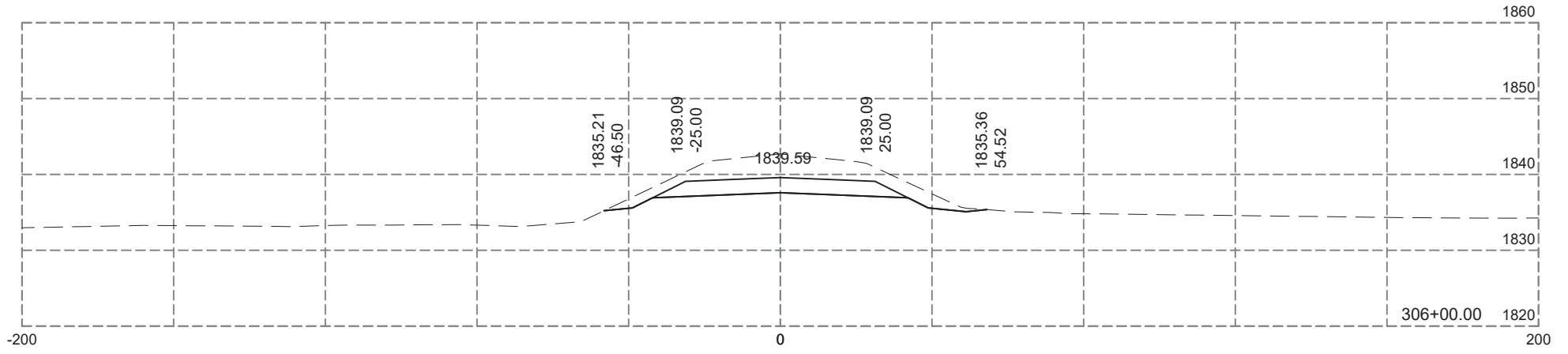

STATE OF SOUTH DAKOTA	PROJECT P-PH-PT 0025(81)158	SHEET X43	TOTAL SHEETS X99
-----------------------	--------------------------------	--------------	---------------------

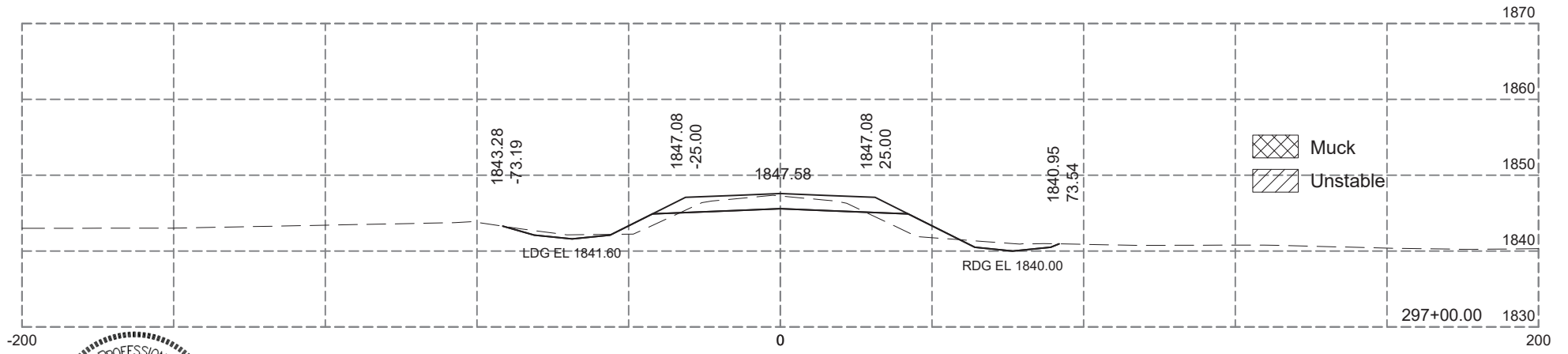
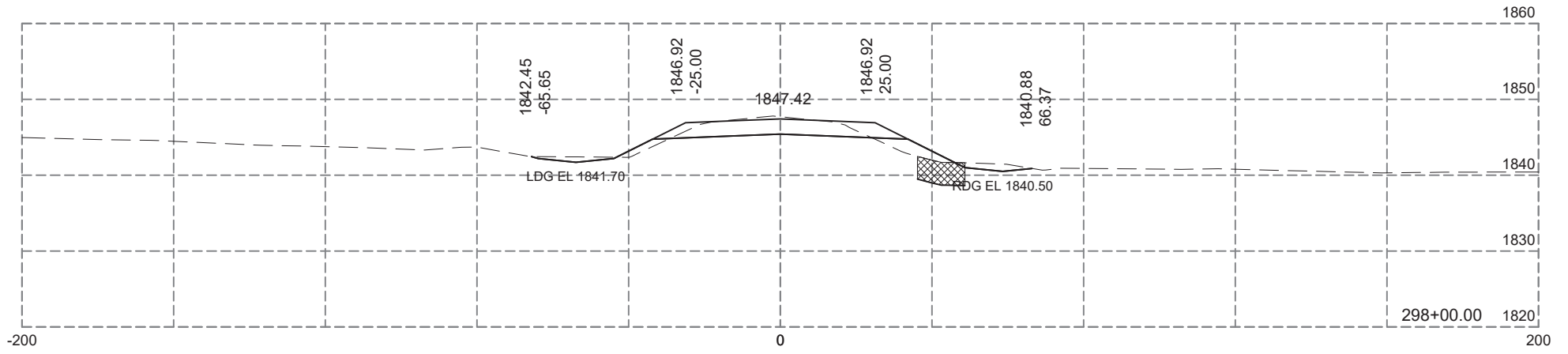
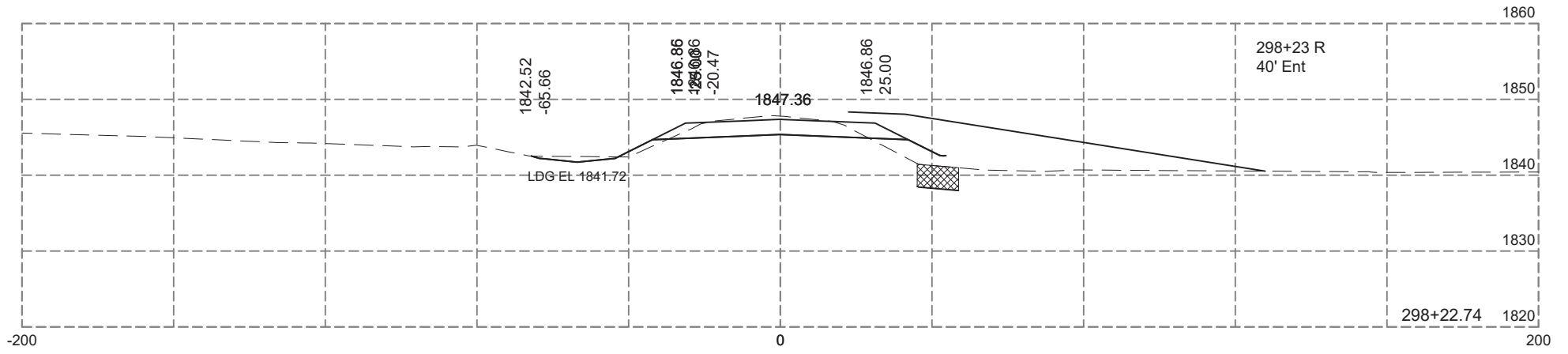
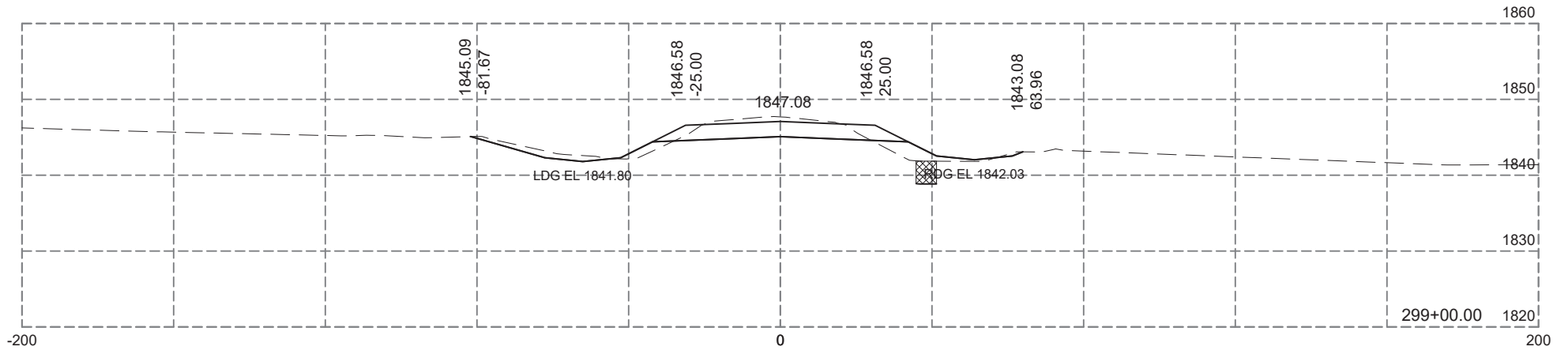
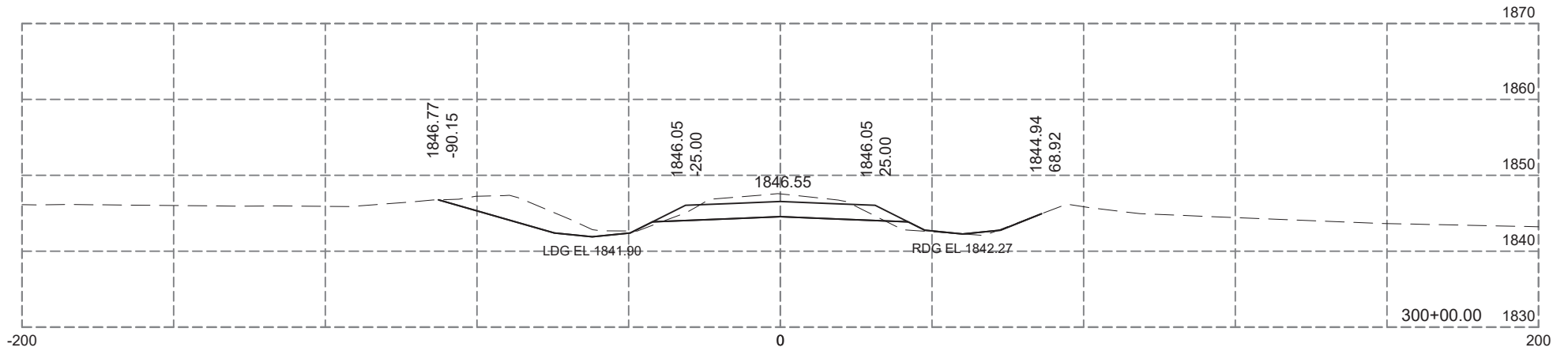
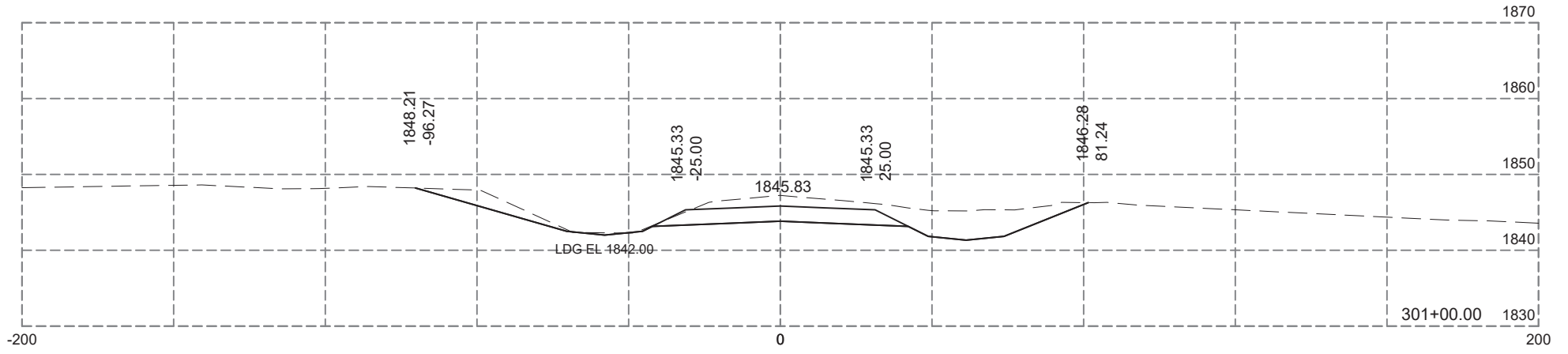

Plotting Date: 12-04-2024

STATE OF SOUTH DAKOTA	PROJECT P-PH-PT 0025(81)158	SHEET X44	TOTAL SHEETS X99
-----------------------	--------------------------------	--------------	---------------------





 Muck  
 Unstable

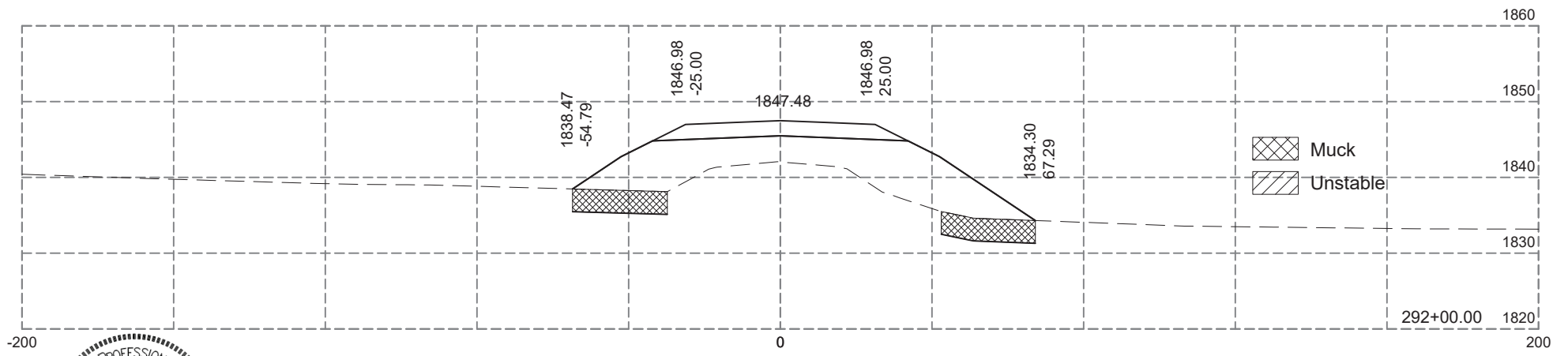
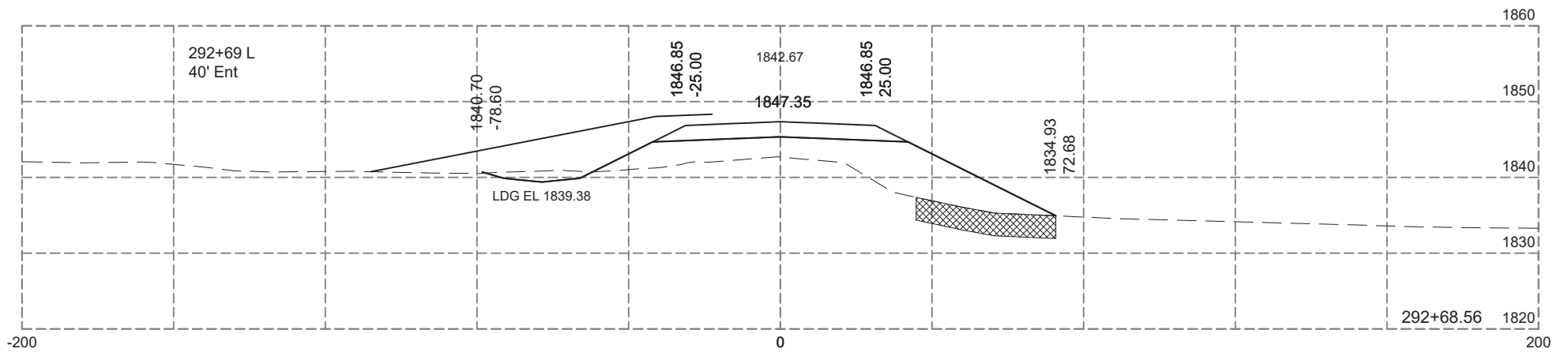
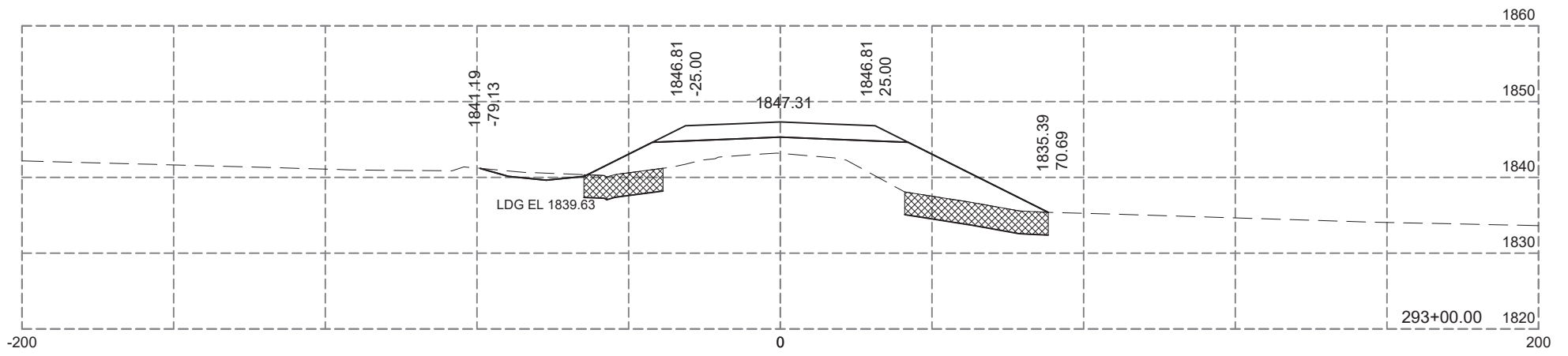
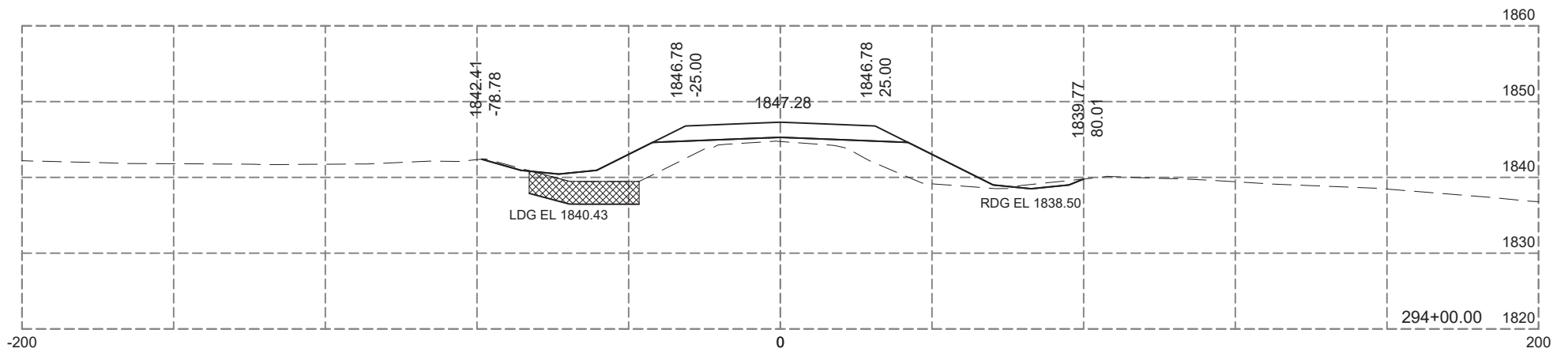
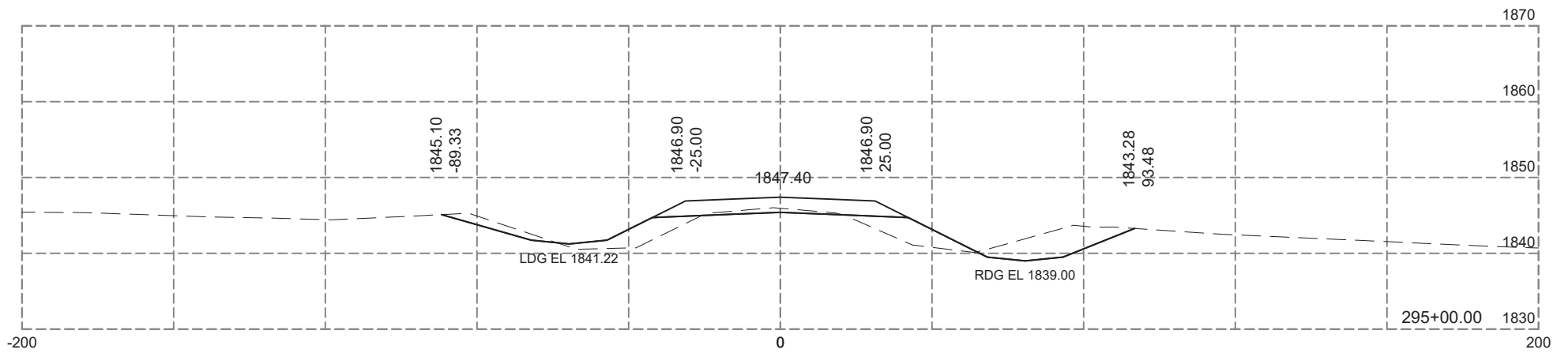
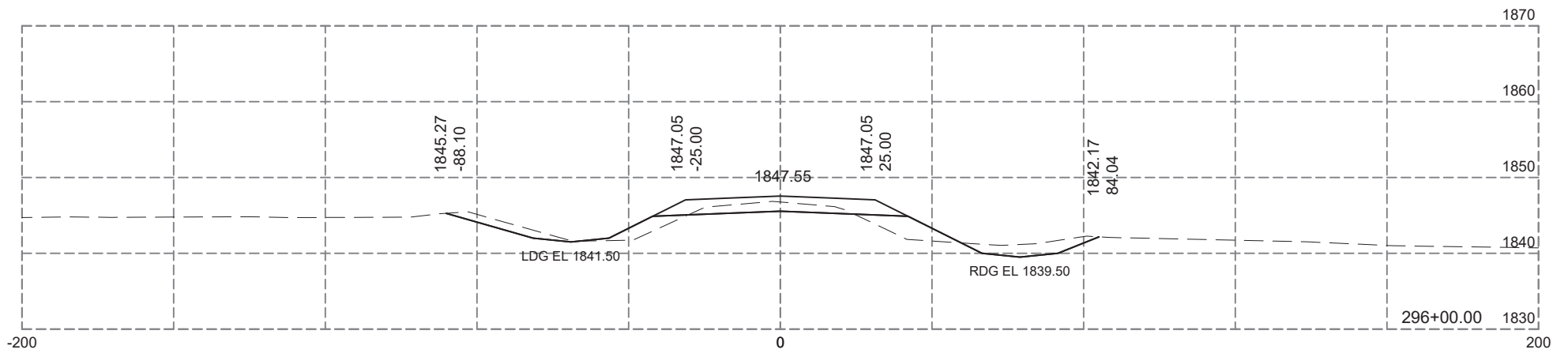

Plotting Date: 12-04-2024

STATE OF SOUTH DAKOTA	PROJECT P-PH-PT 0025(81)158	SHEET X45	TOTAL SHEETS X99
-----------------------	--------------------------------	--------------	---------------------



 Muck  
 Unstable



Plotting Date: 12-04-2024

STATE OF SOUTH DAKOTA	PROJECT P-PH-PT 0025(81)158	SHEET X46	TOTAL SHEETS X99
-----------------------	--------------------------------	--------------	---------------------

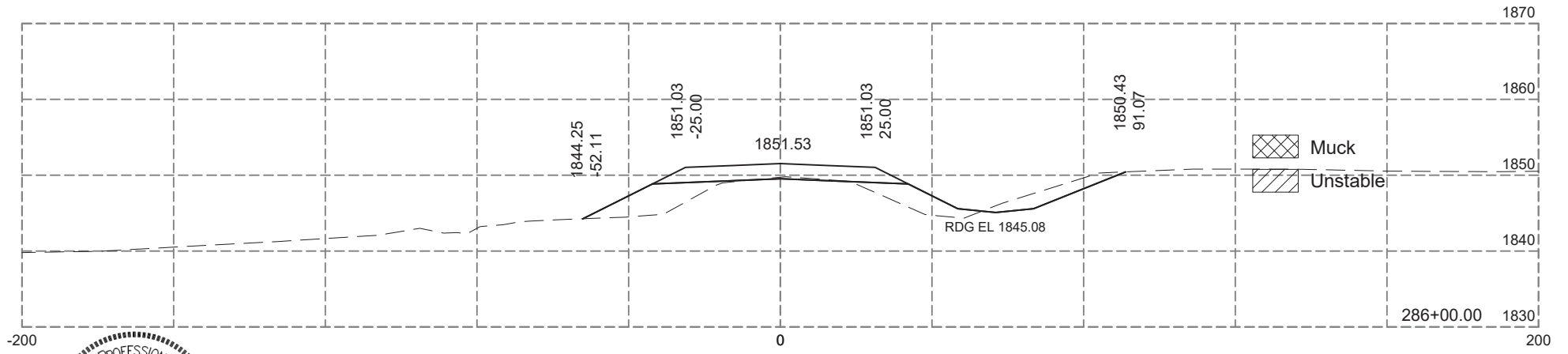
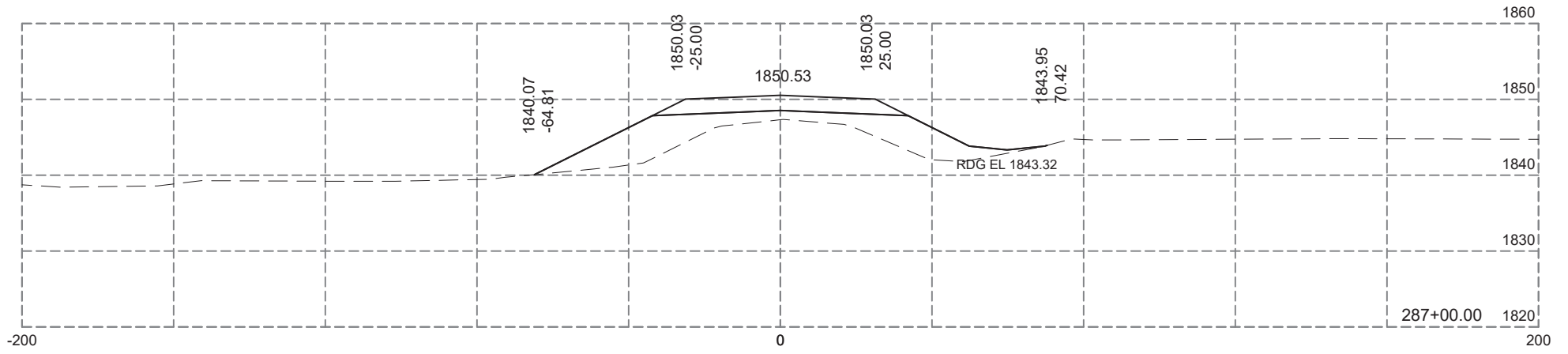
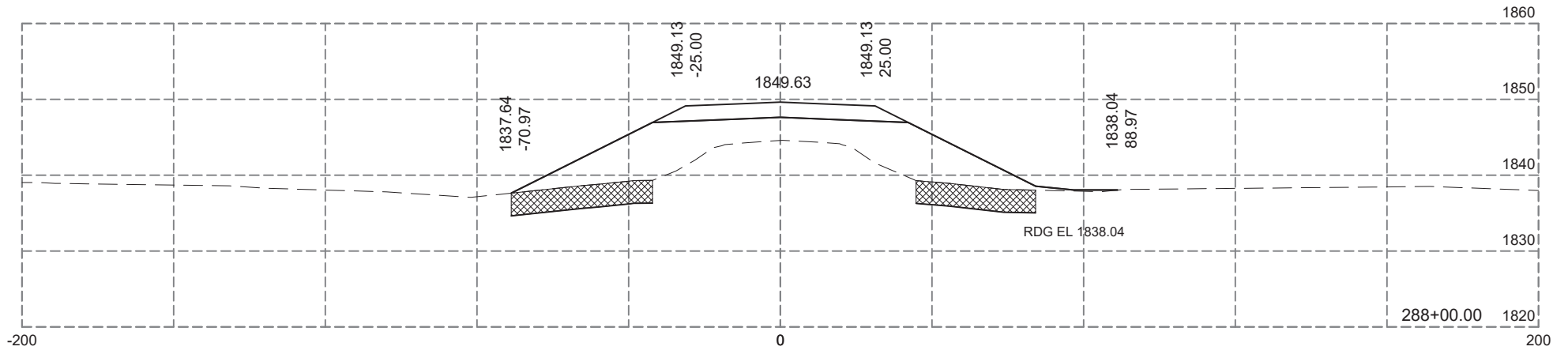
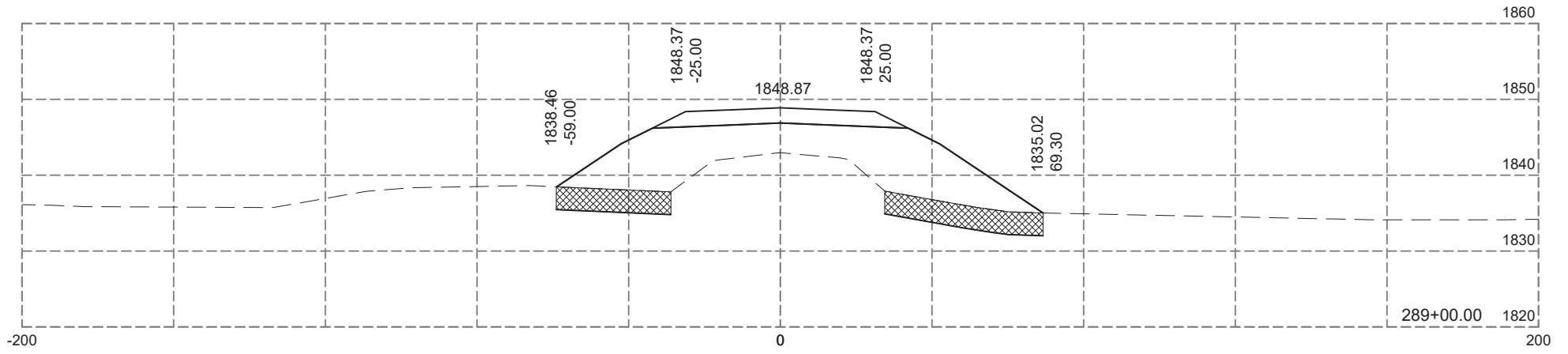
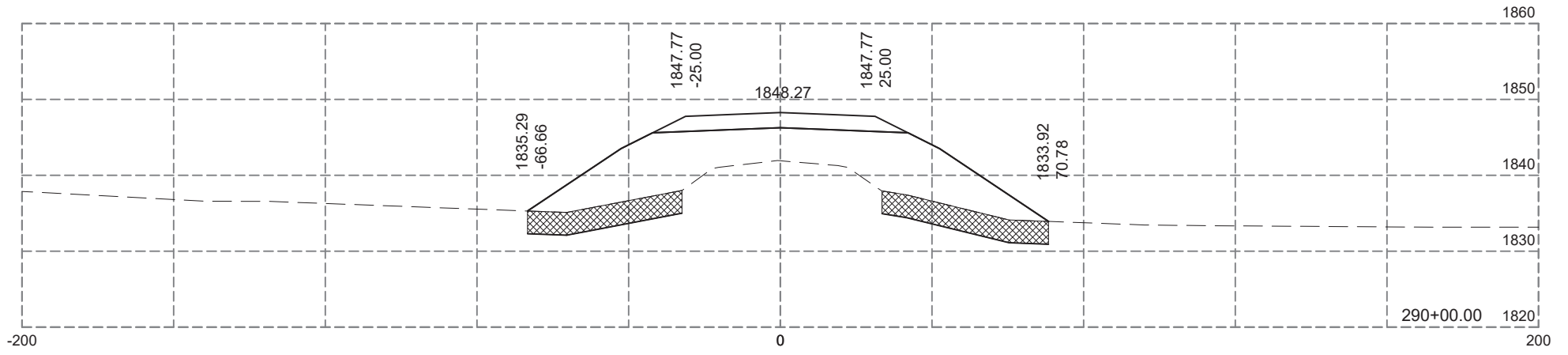
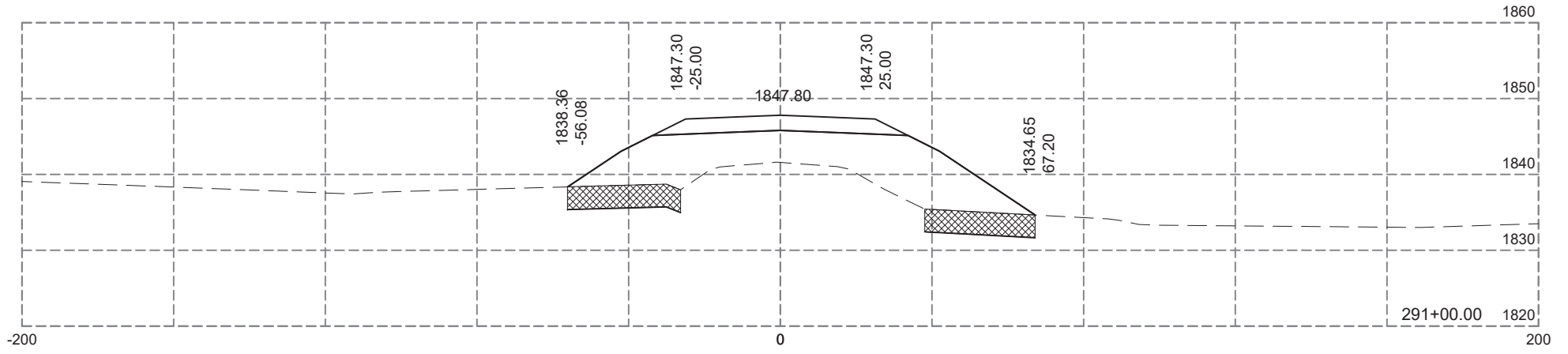

Muck  
 Unstable



Plotting Date: 12-04-2024

STATE OF SOUTH DAKOTA	PROJECT	SHEET	TOTAL SHEETS
	P-PH-PT 0025(81)158	X47	X99

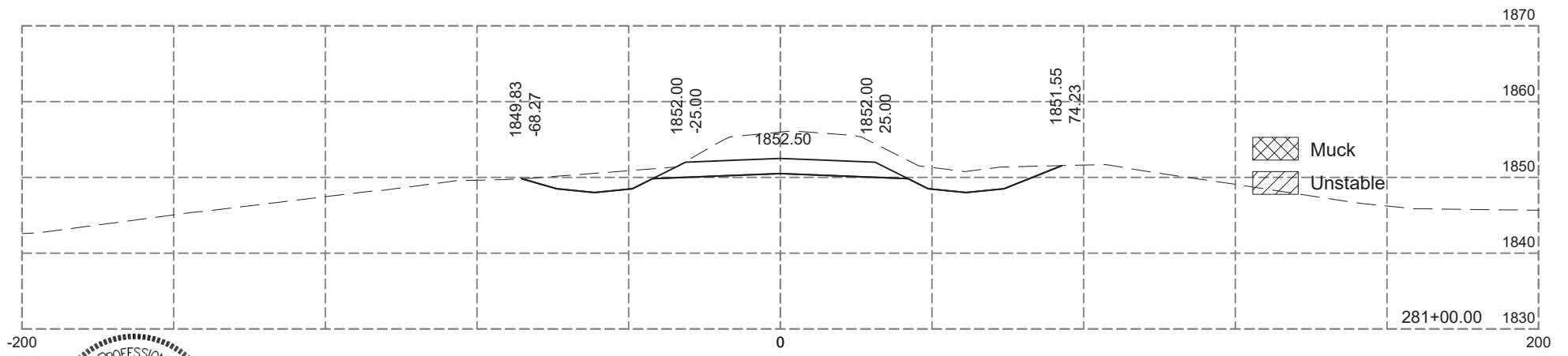
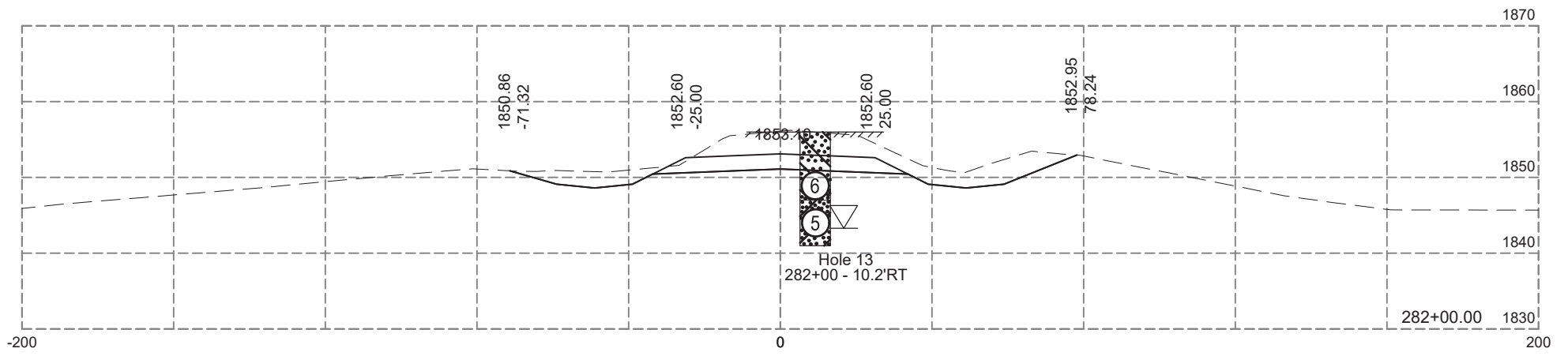
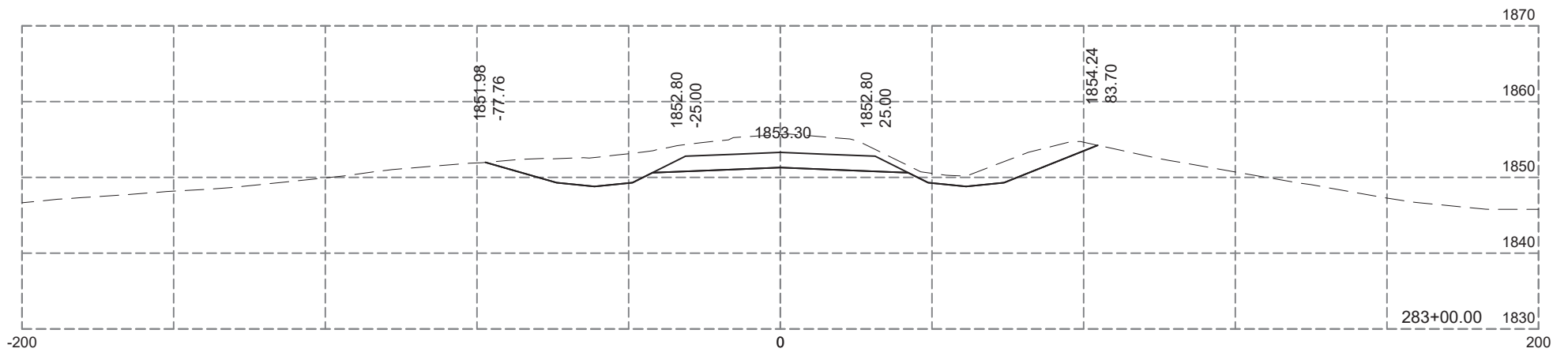
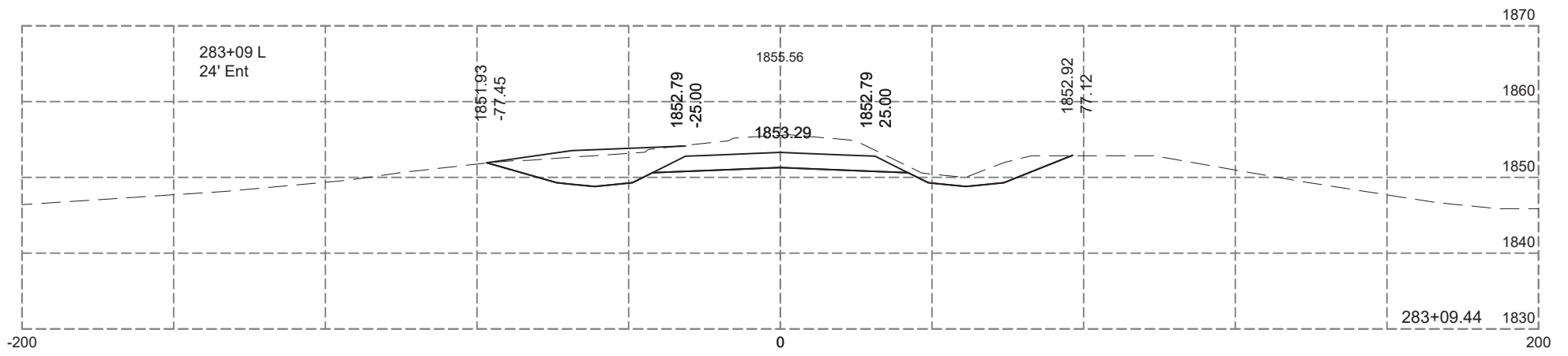
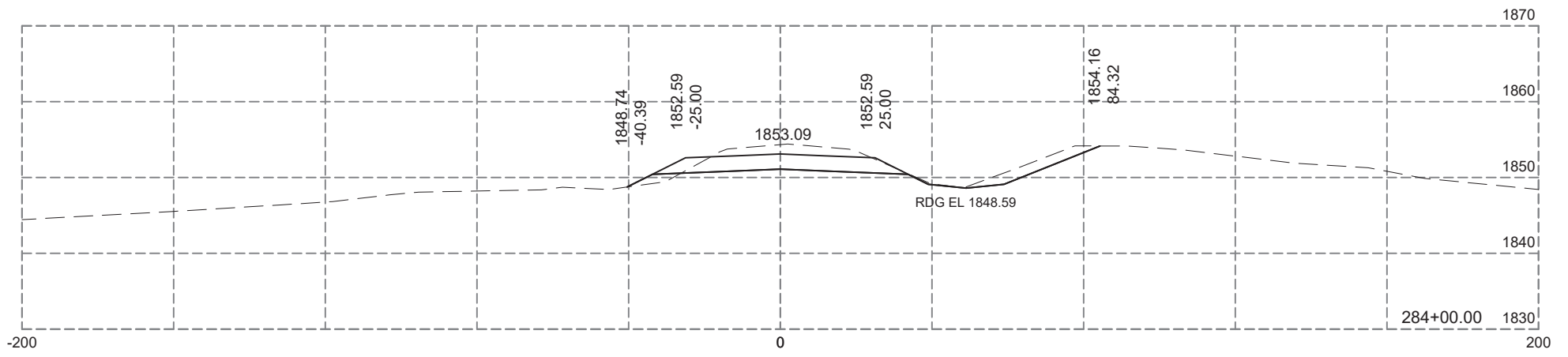
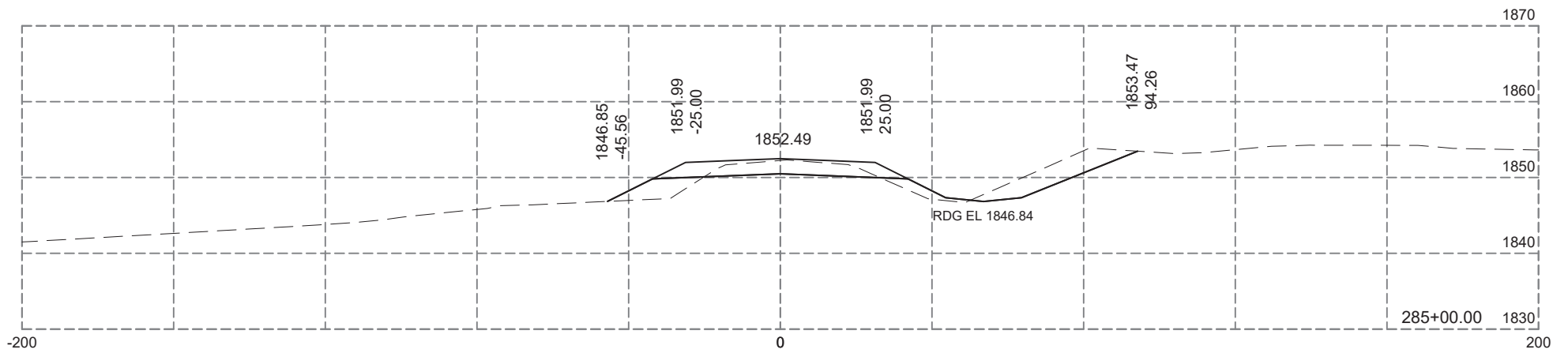

Muck  
 Unstable



Plotting Date: 12-04-2024

STATE OF SOUTH DAKOTA	PROJECT P-PH-PT 0025(81)158	SHEET X48	TOTAL SHEETS X99
-----------------------	--------------------------------	--------------	---------------------



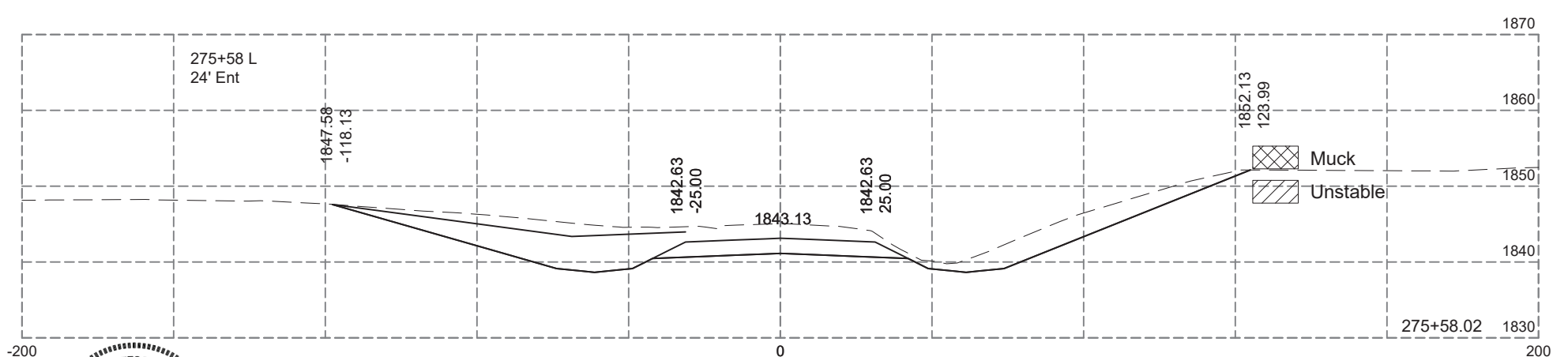
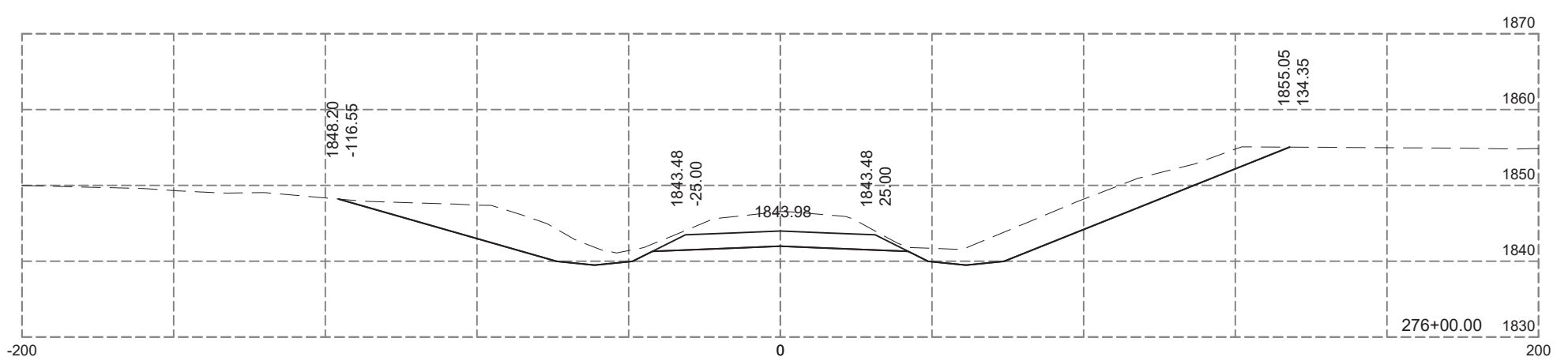
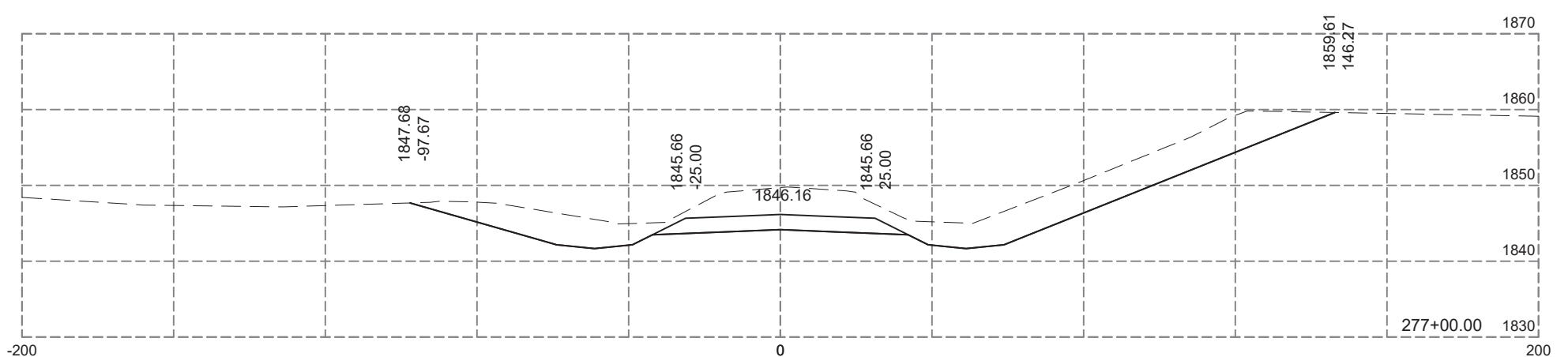
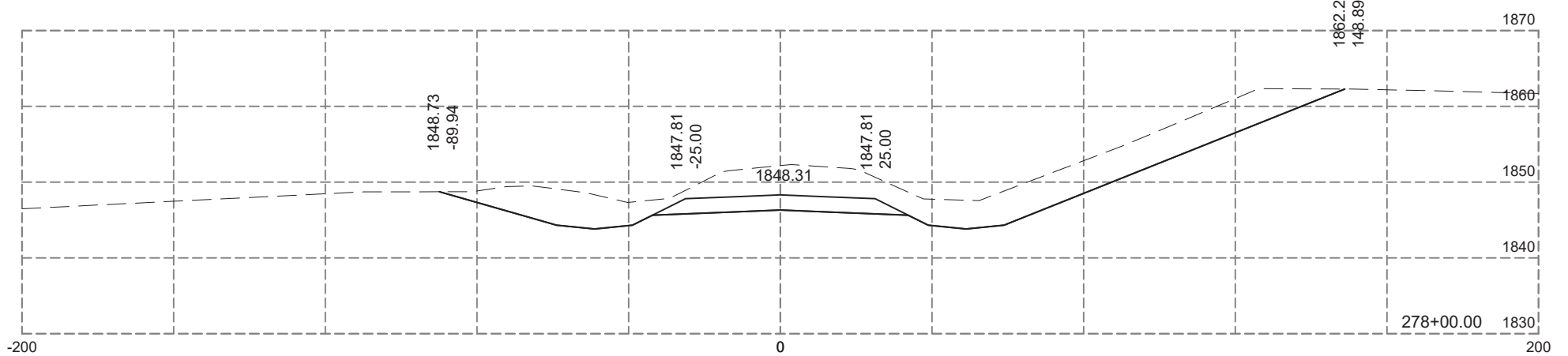
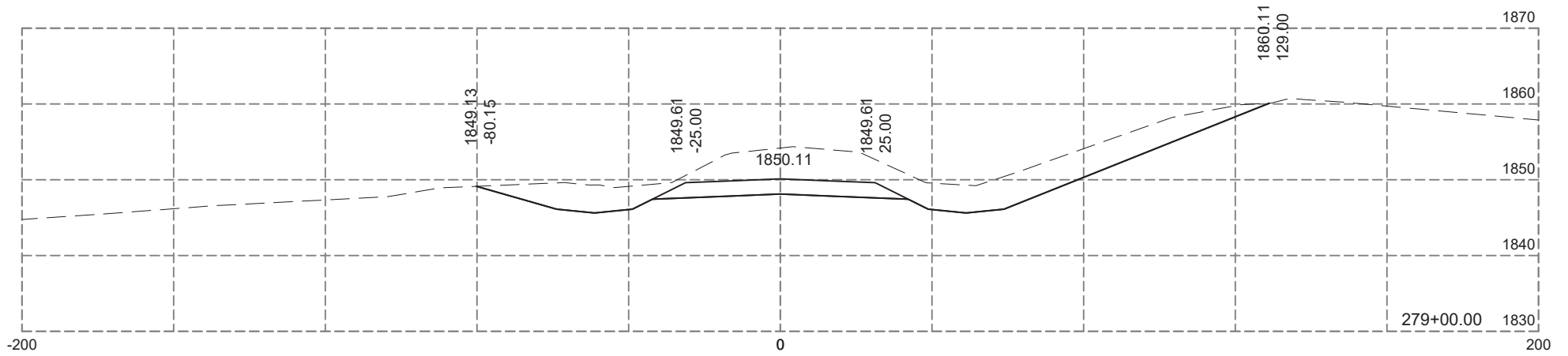
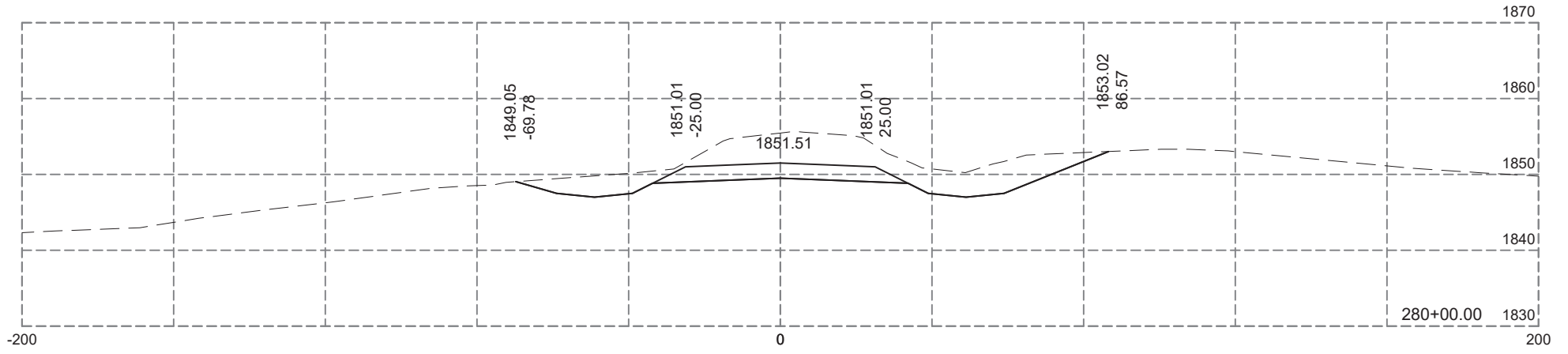

Plotting Date: 12-04-2024

STATE OF SOUTH DAKOTA	PROJECT P-PH-PT 0025(81)158	SHEET X49	TOTAL SHEETS X99
-----------------------	--------------------------------	--------------	---------------------

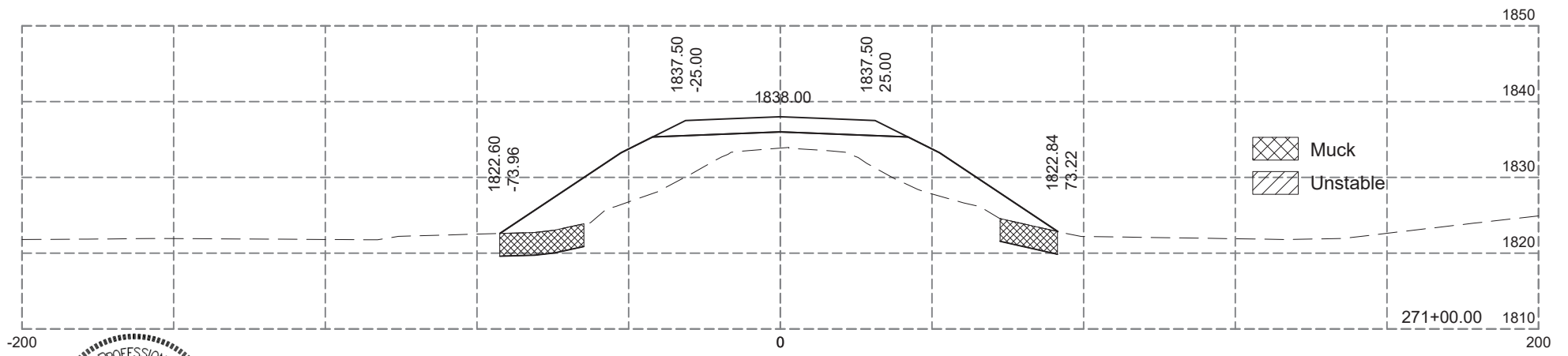
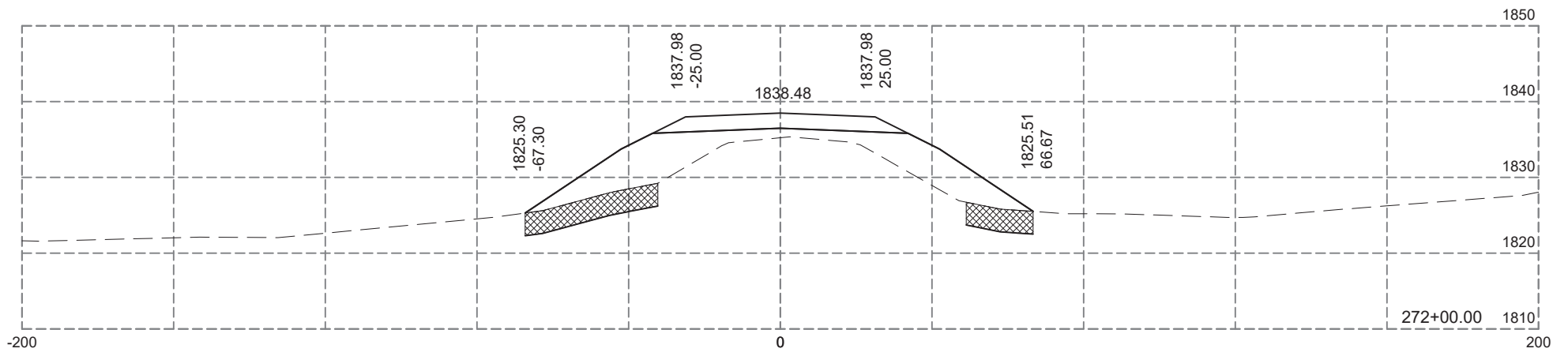
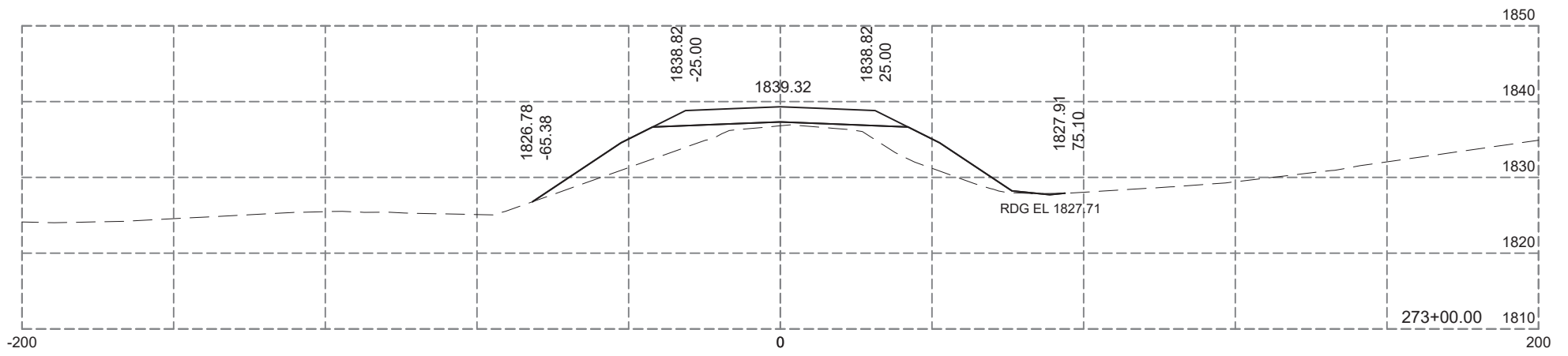
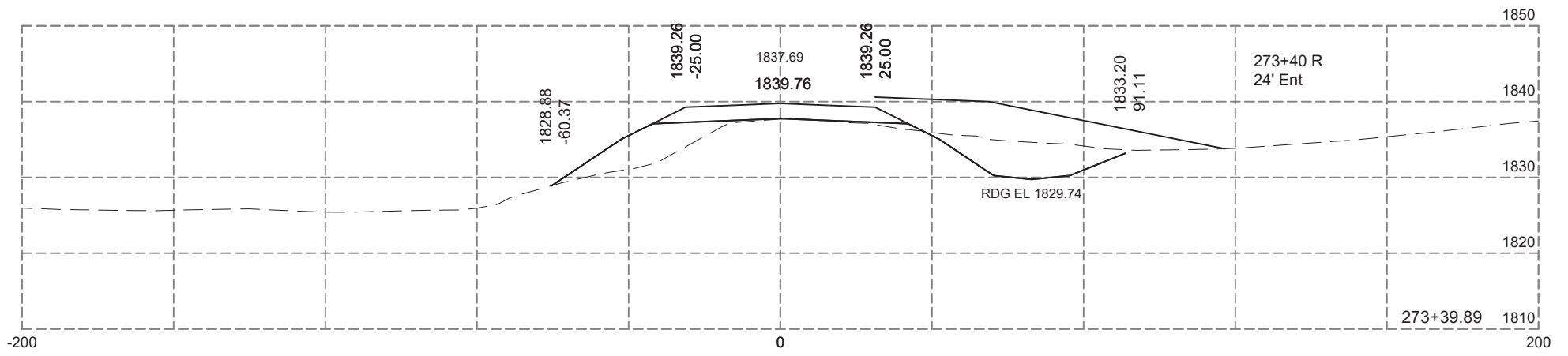
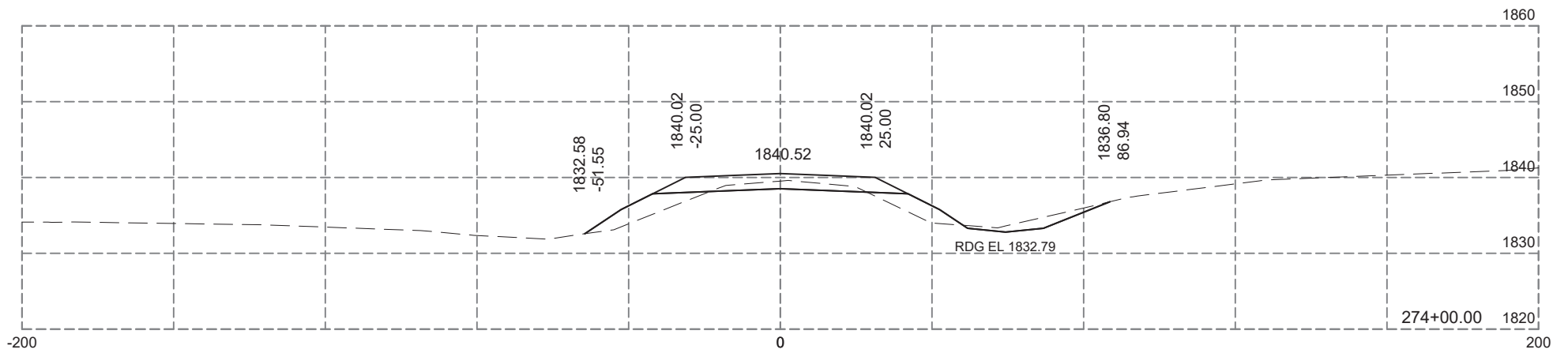
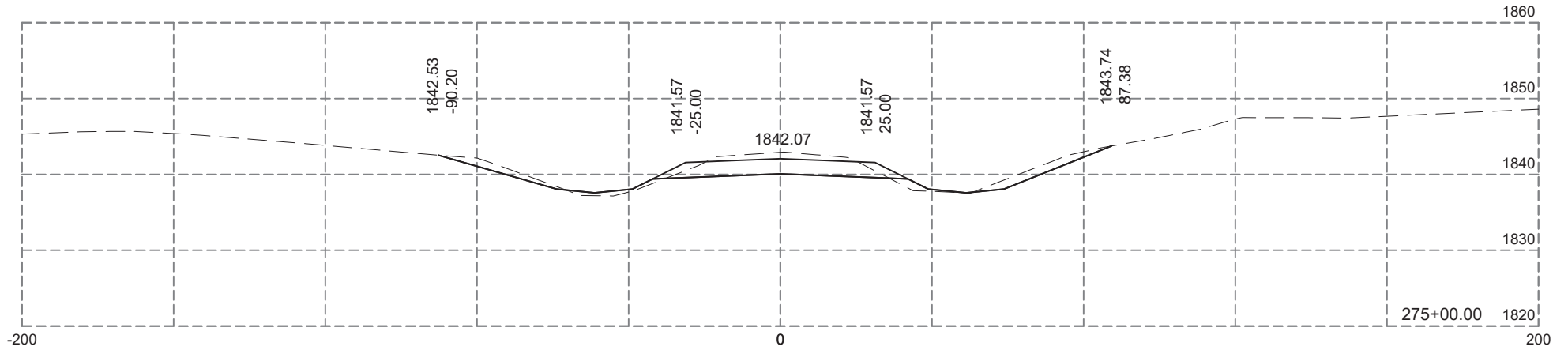

Plotting Date: 12-04-2024

STATE OF SOUTH DAKOTA	PROJECT P-PH-PT 0025(81)158	SHEET X50	TOTAL SHEETS X99
-----------------------	--------------------------------	--------------	---------------------

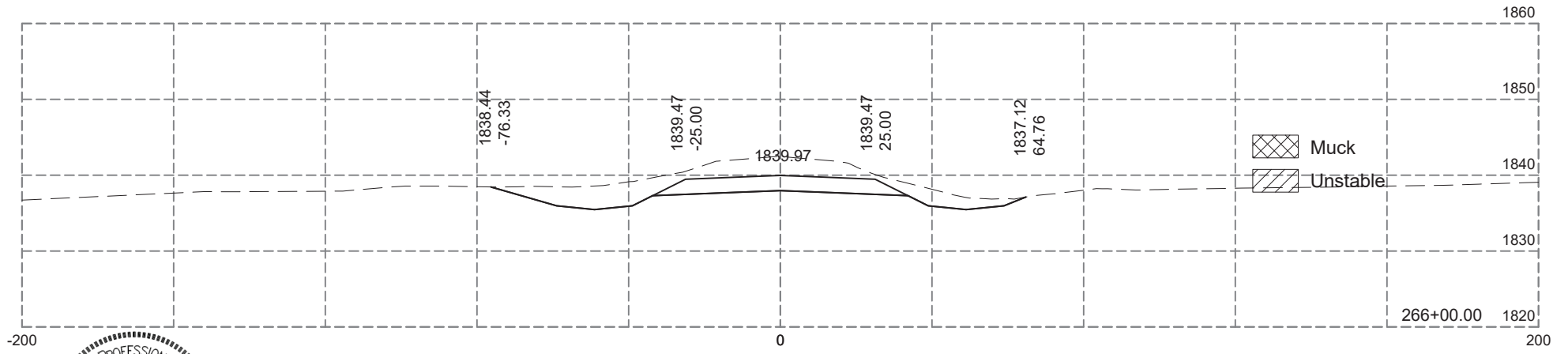
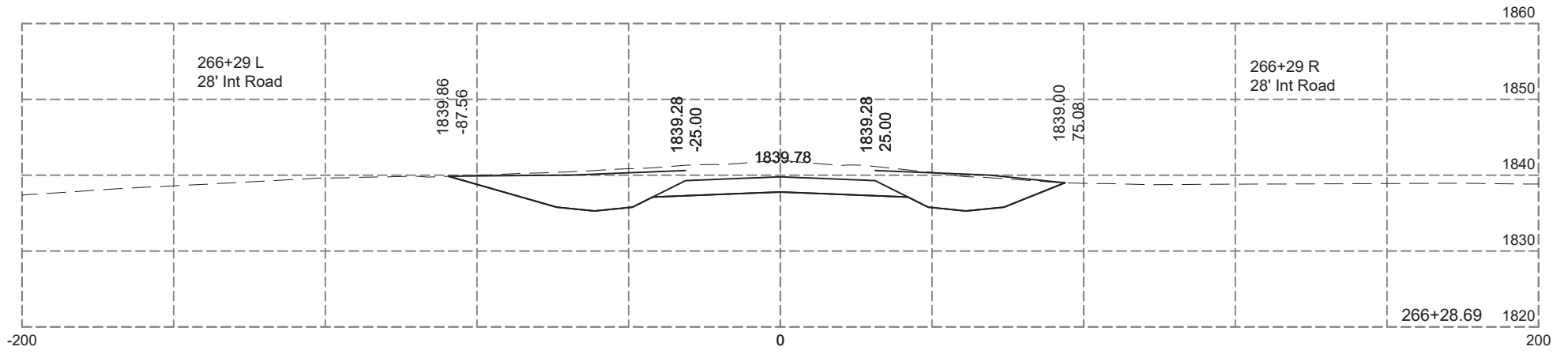
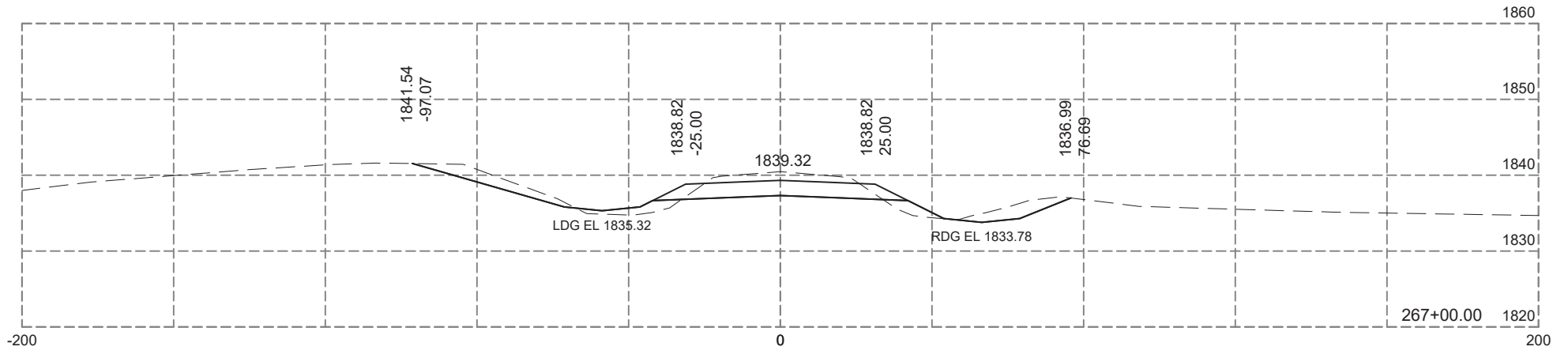
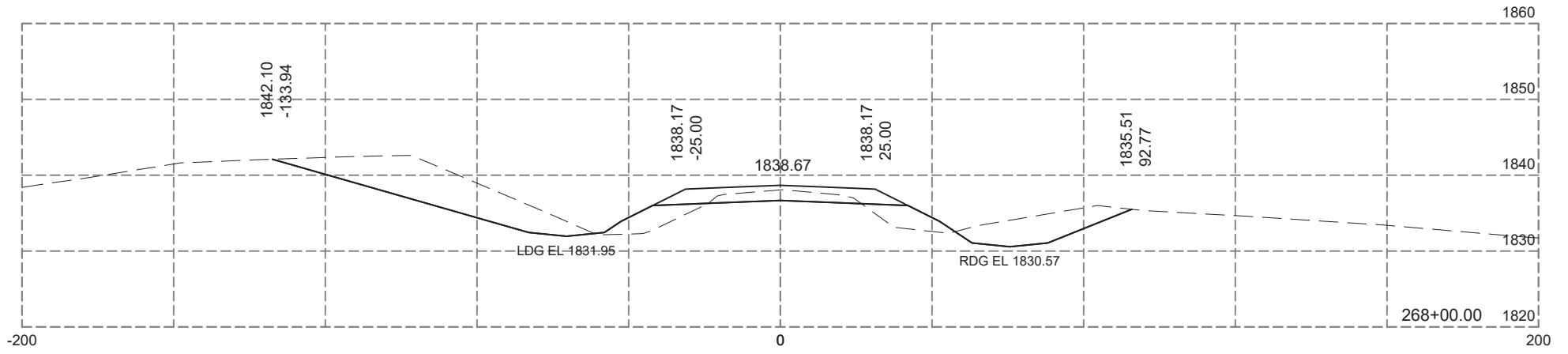
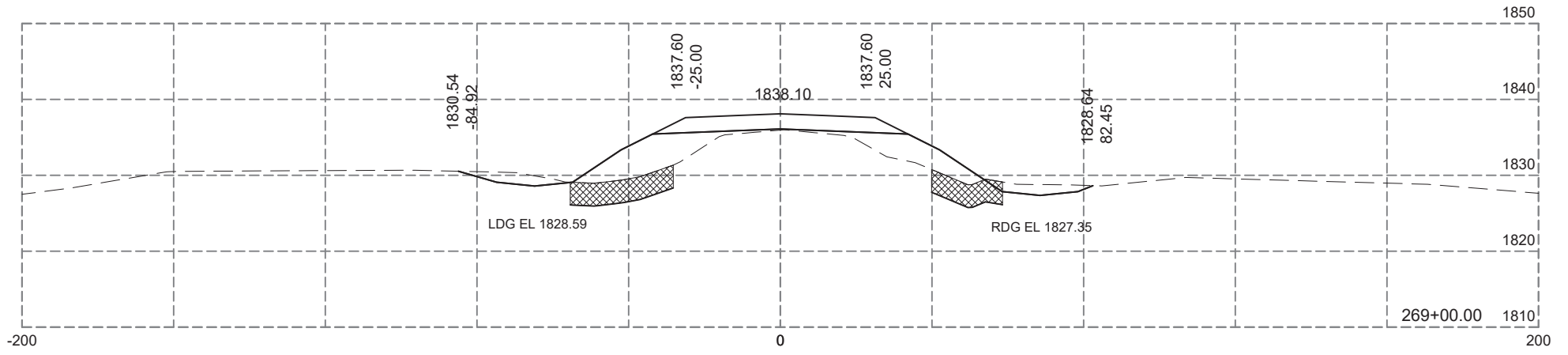
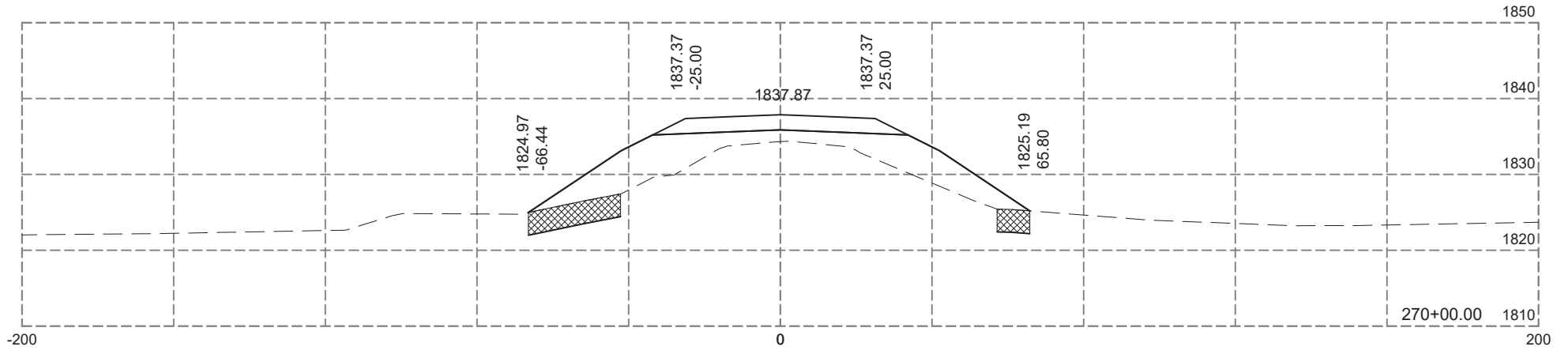

Plotting Date: 12-04-2024

STATE OF SOUTH DAKOTA	PROJECT P-PH-PT 0025(81)158	SHEET X51	TOTAL SHEETS X99
-----------------------	--------------------------------	--------------	---------------------

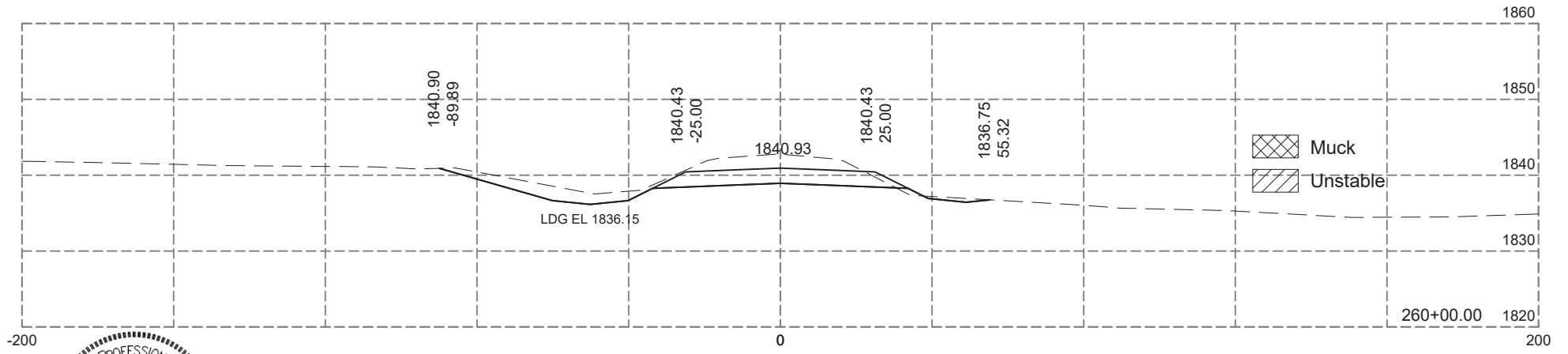
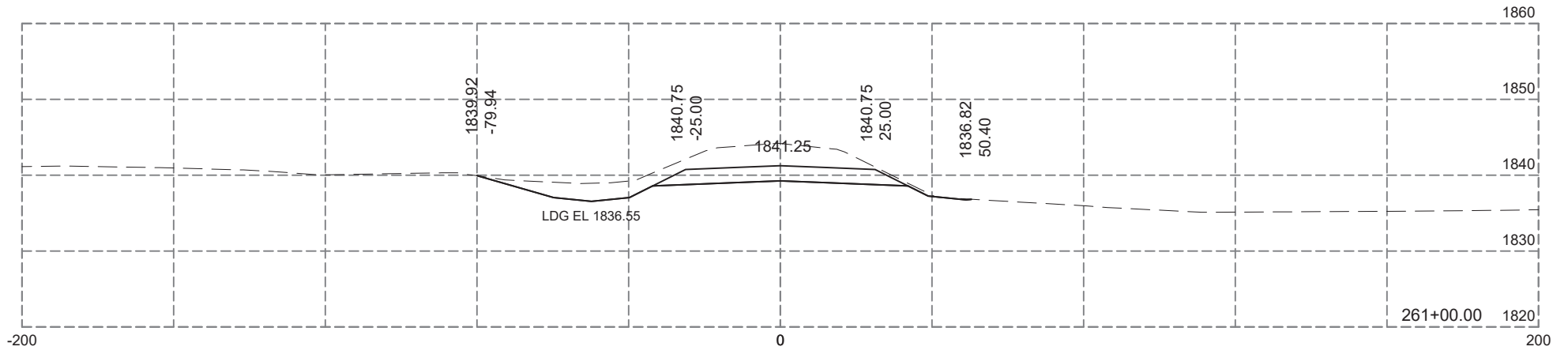
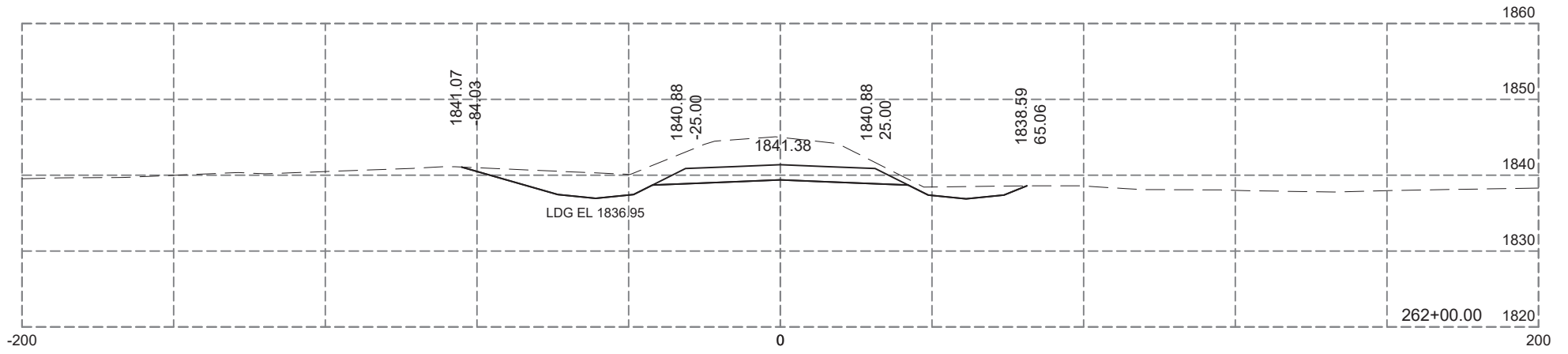
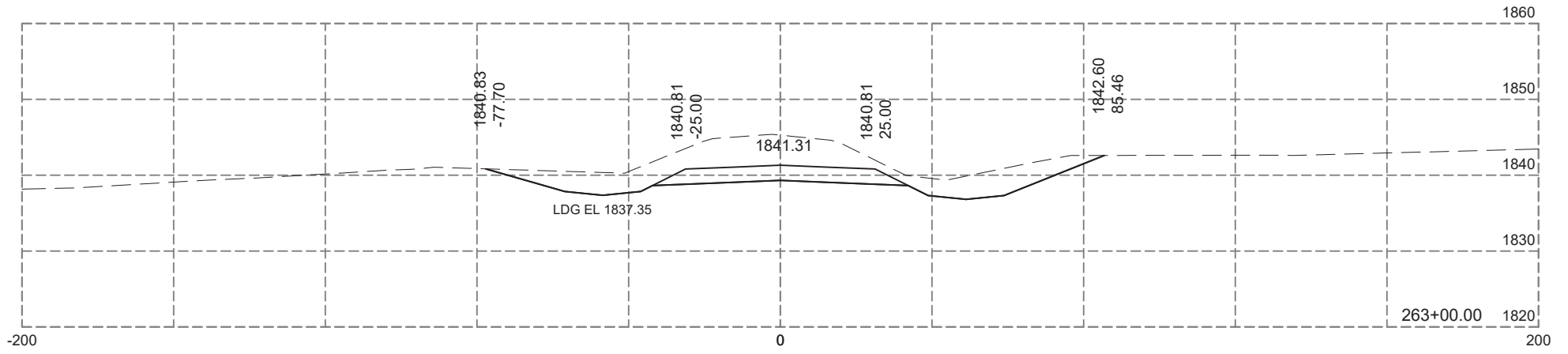
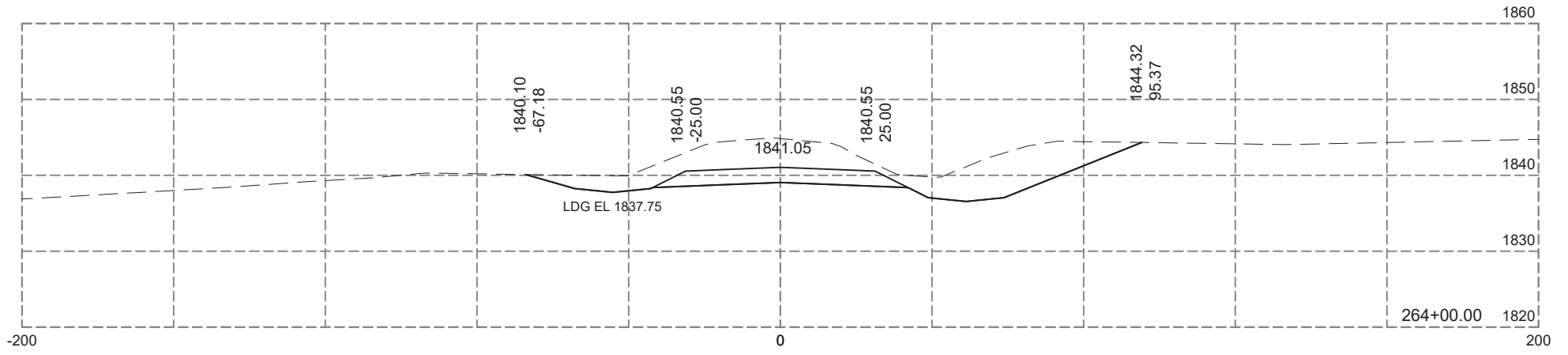
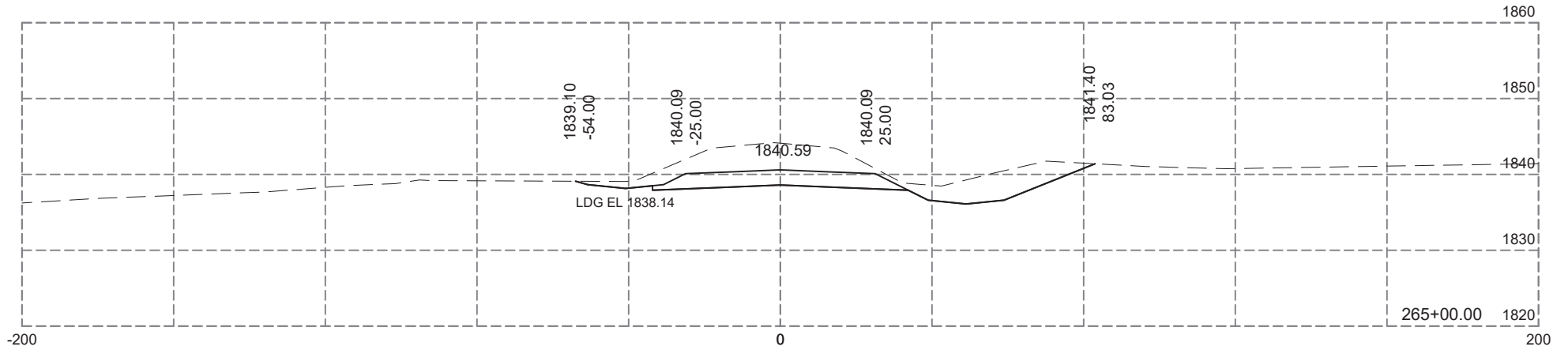

Plotting Date: 12-04-2024

STATE OF SOUTH DAKOTA	PROJECT P-PH-PT 0025(81)158	SHEET X52	TOTAL SHEETS X99
-----------------------	--------------------------------	--------------	---------------------

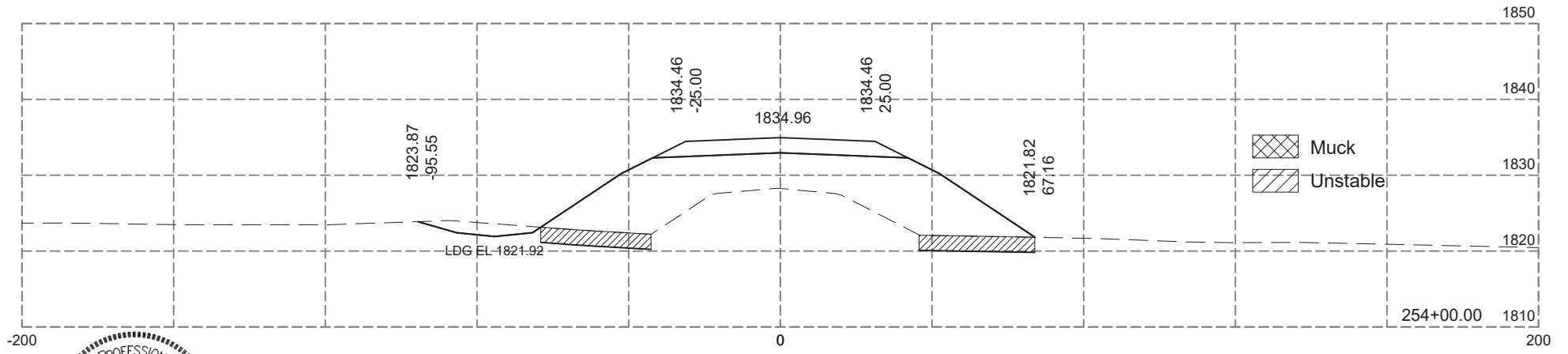
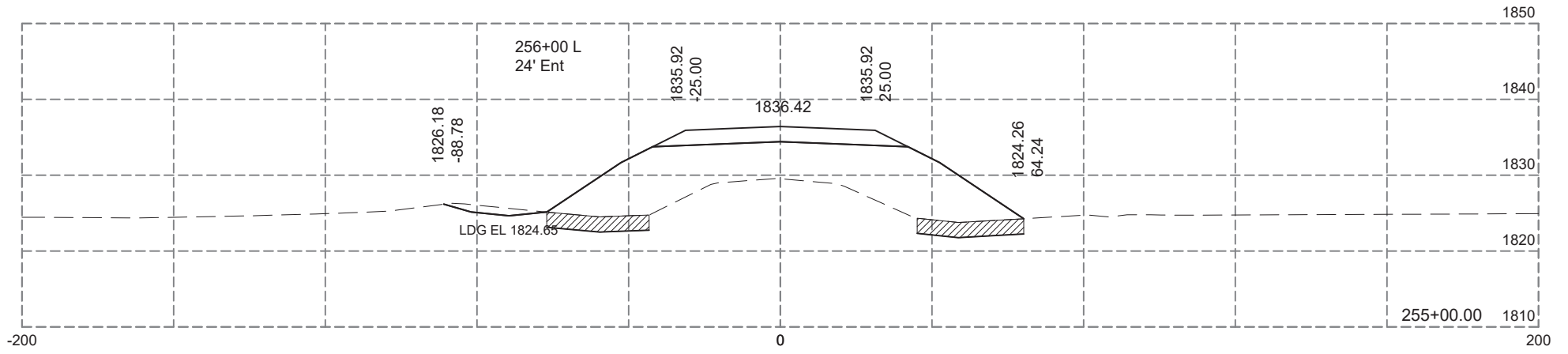
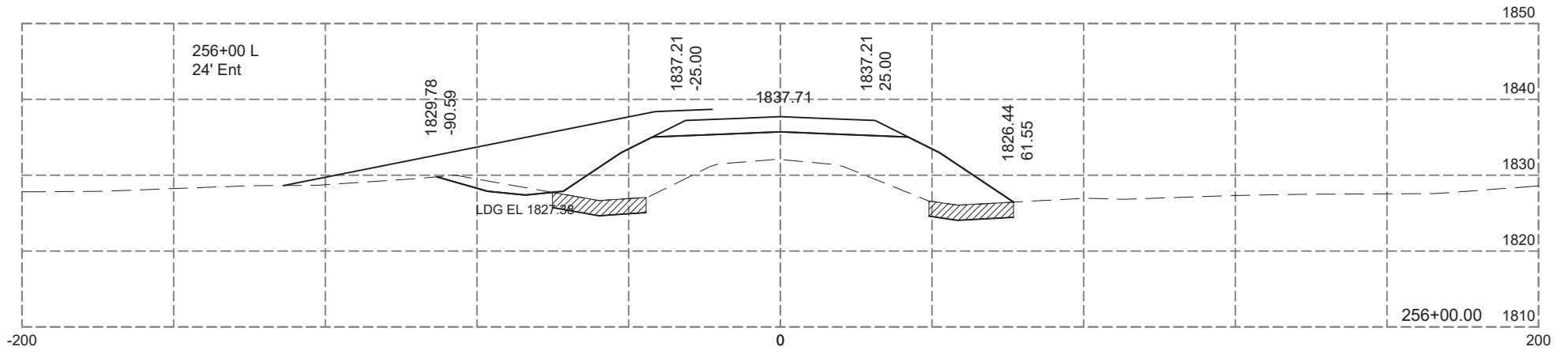
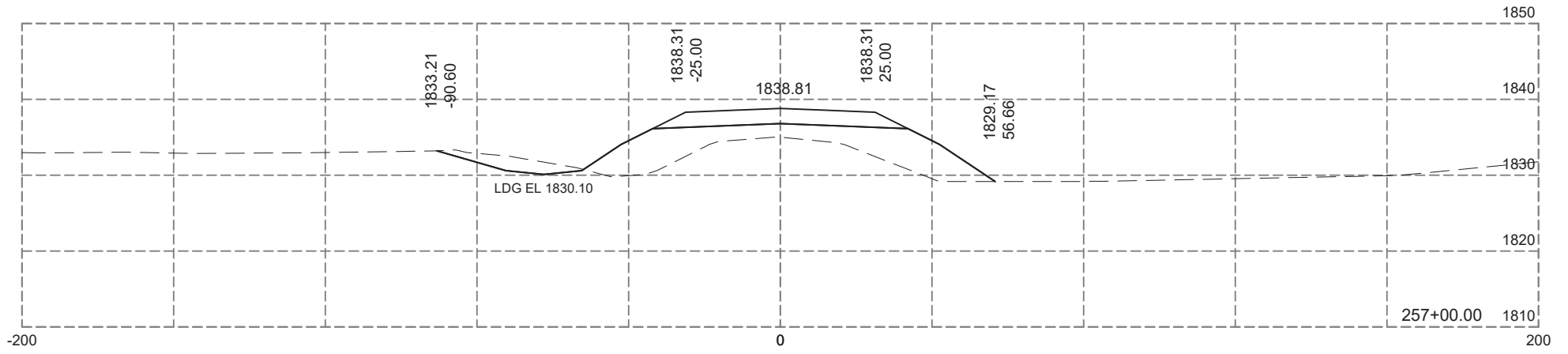
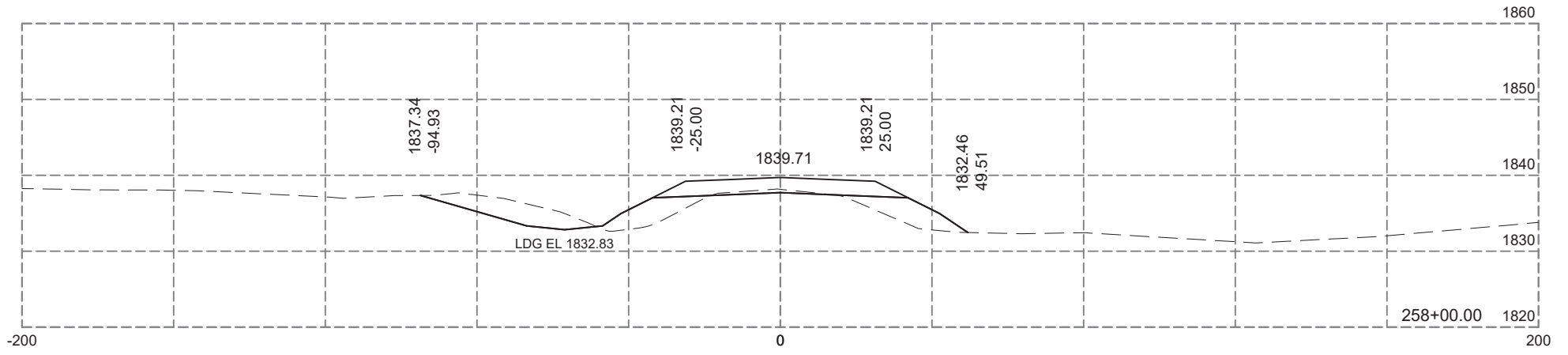
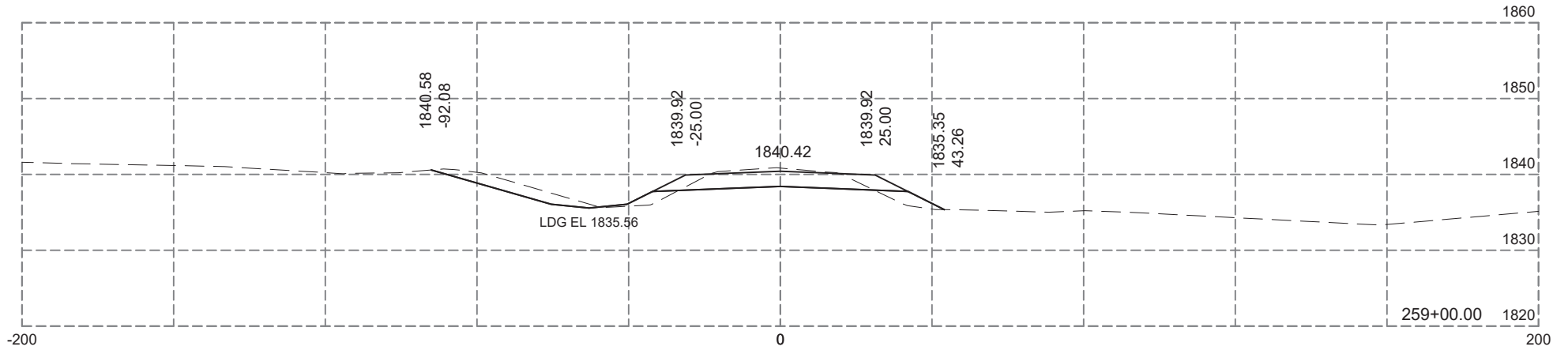

 Muck  
 Unstable



Plotting Date: 12-04-2024

STATE OF SOUTH DAKOTA	PROJECT	SHEET	TOTAL SHEETS
	P-PH-PT 0025(81)158	X53	X99

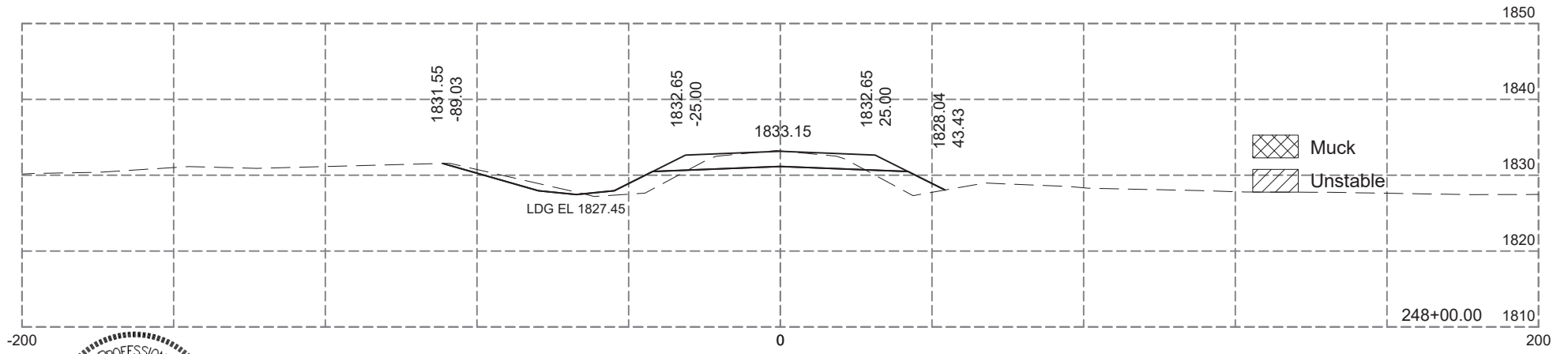
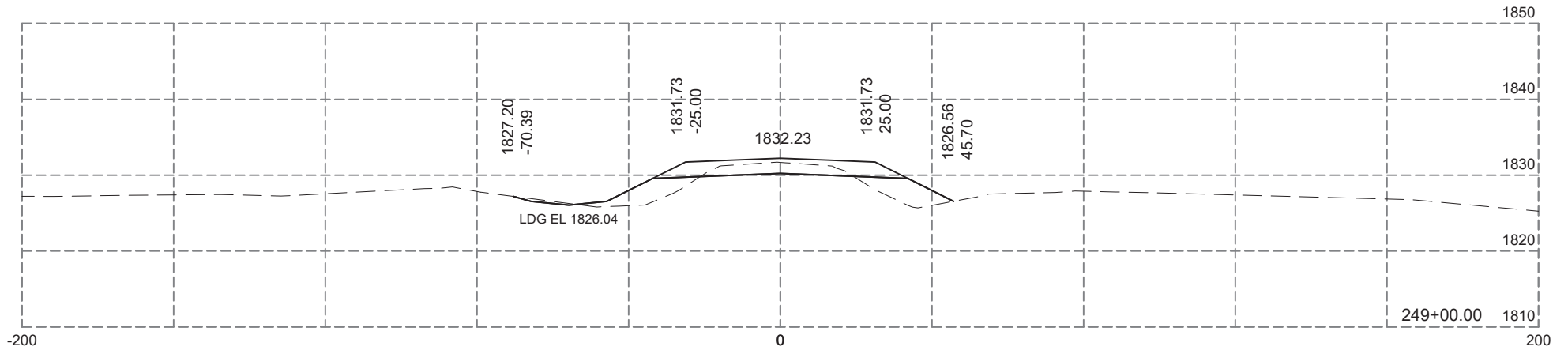
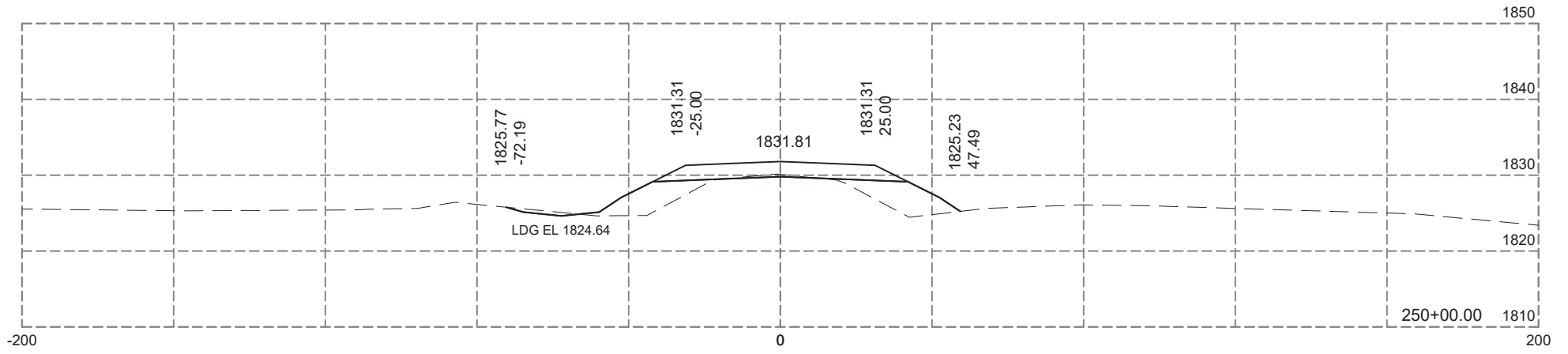
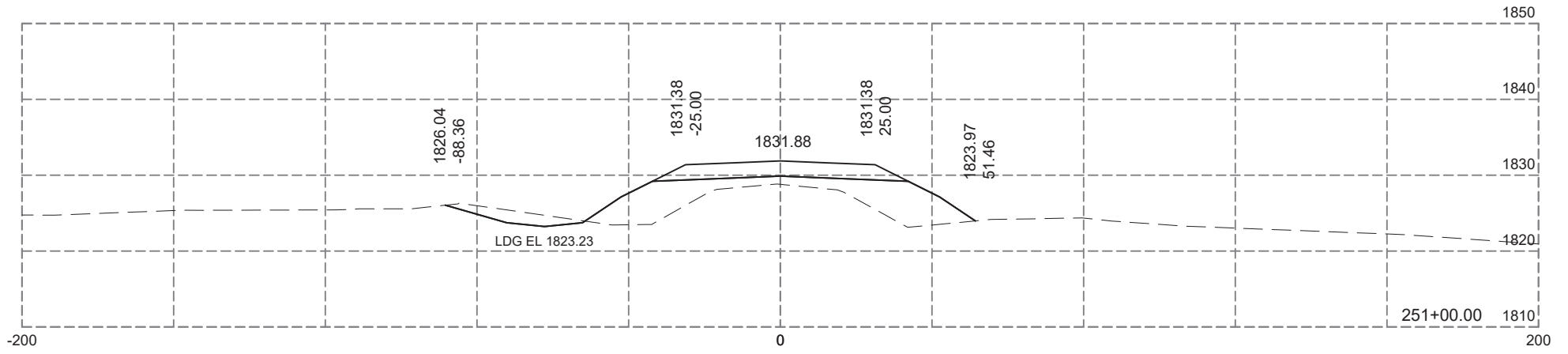
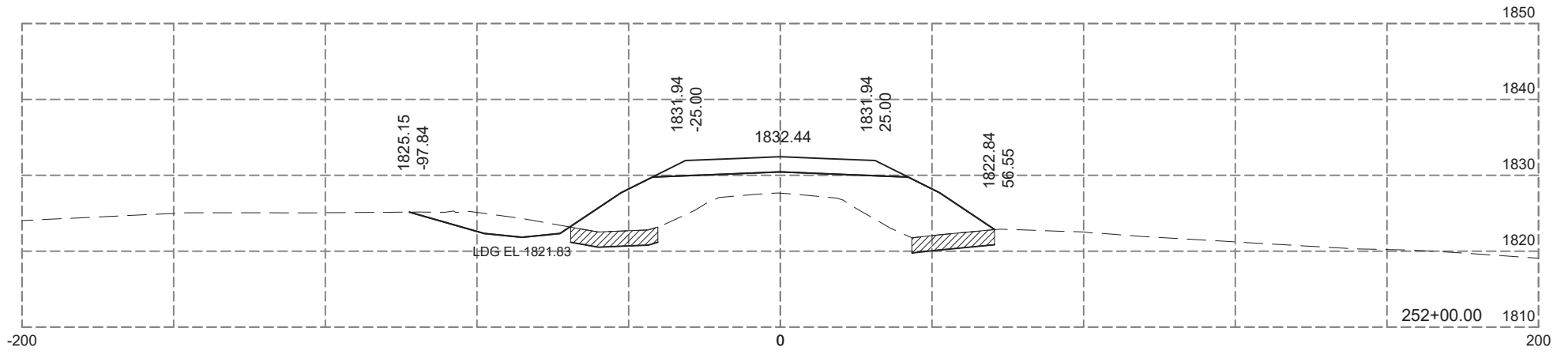
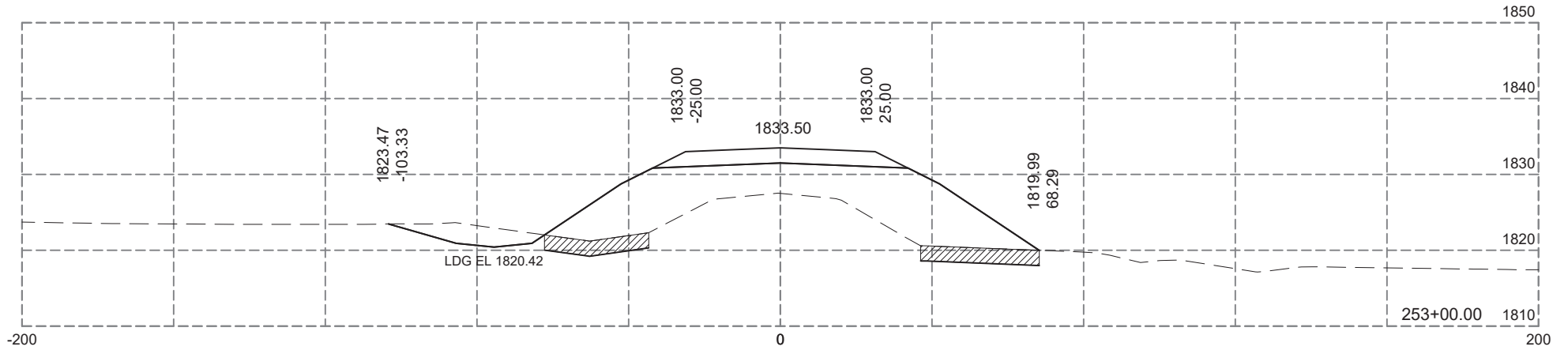



 Muck  
 Unstable

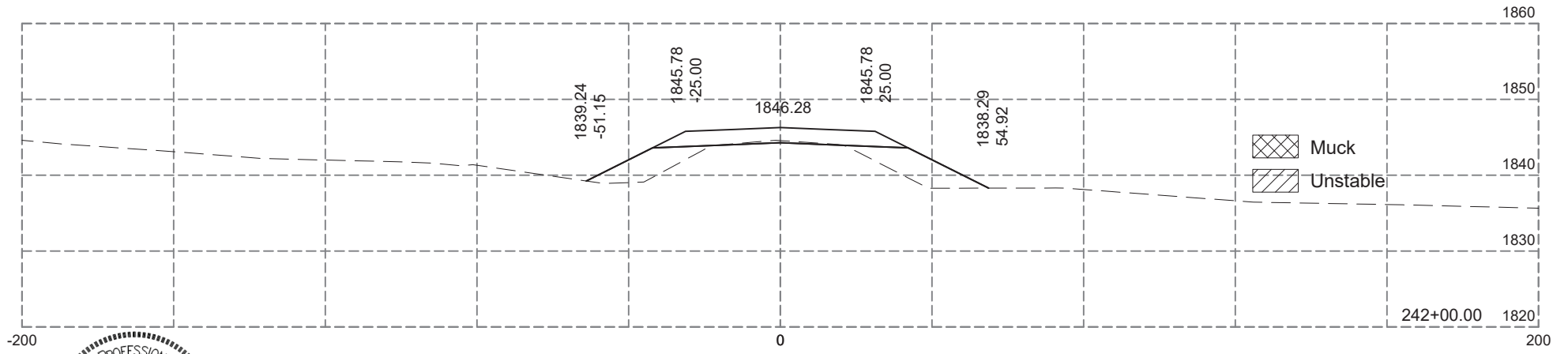
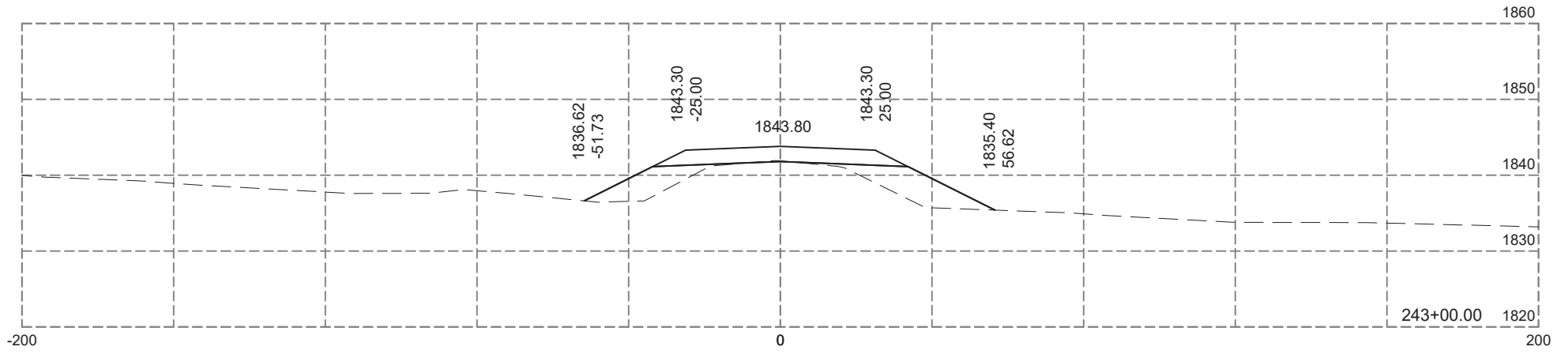
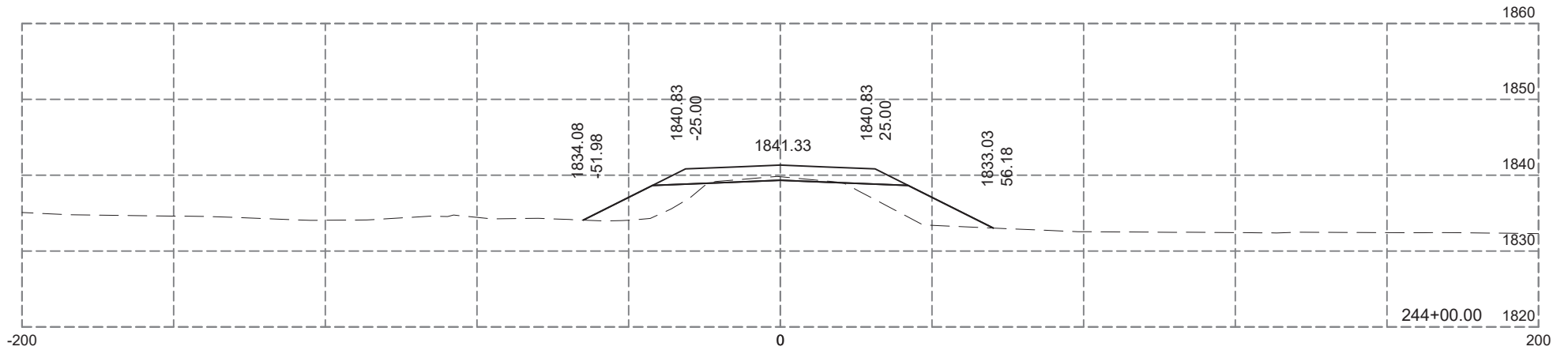
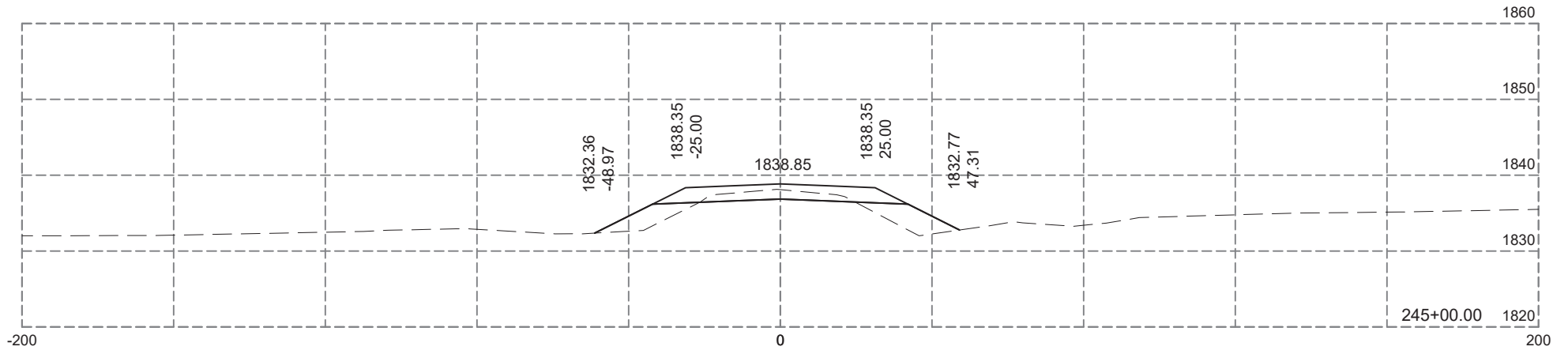
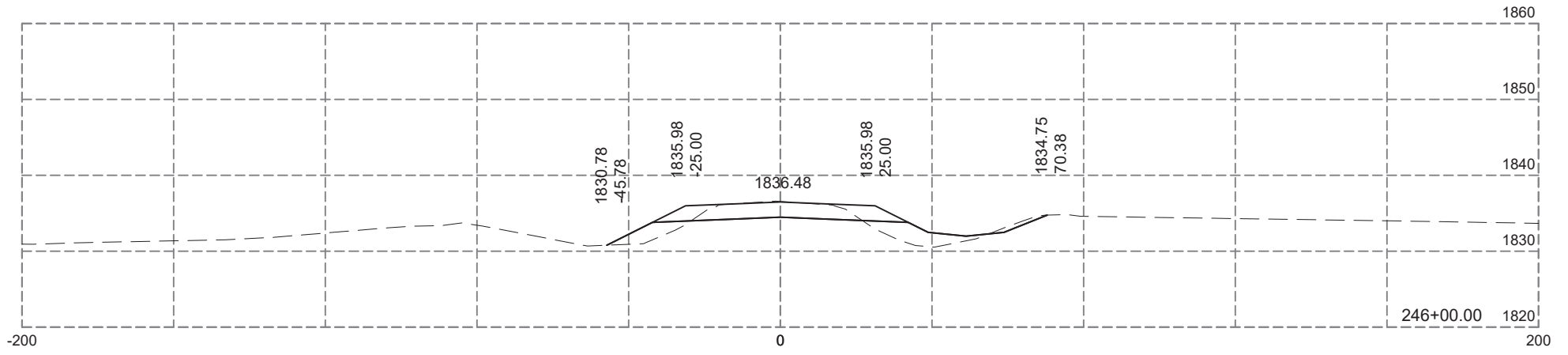
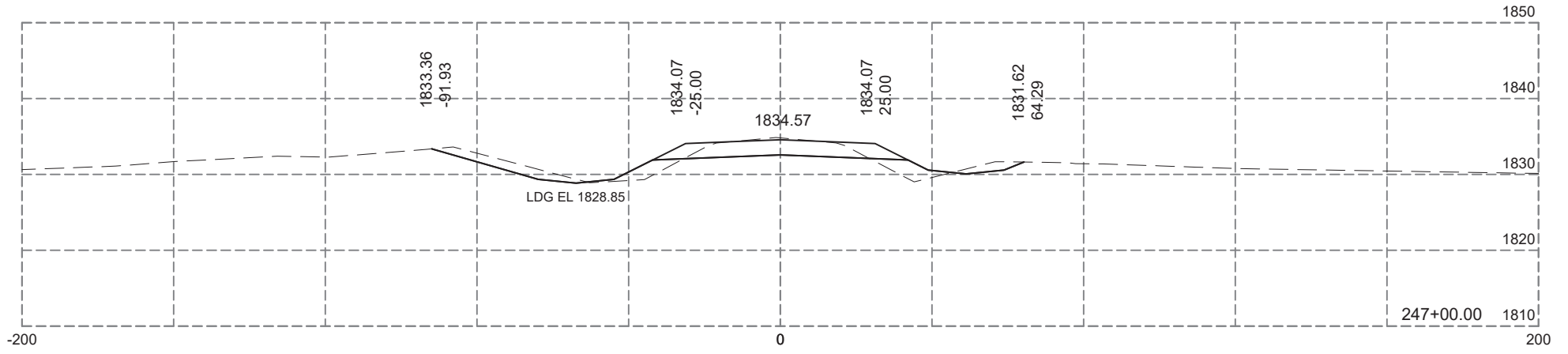

Plotting Date: 12-04-2024

STATE OF SOUTH DAKOTA	PROJECT	SHEET	TOTAL SHEETS
	P-PH-PT 0025(81)158	X54	X99



 Muck  
 Unstable



Plotting Date: 12-04-2024

STATE OF SOUTH DAKOTA	PROJECT	SHEET	TOTAL SHEETS
	P-PH-PT 0025(81)158	X55	X99

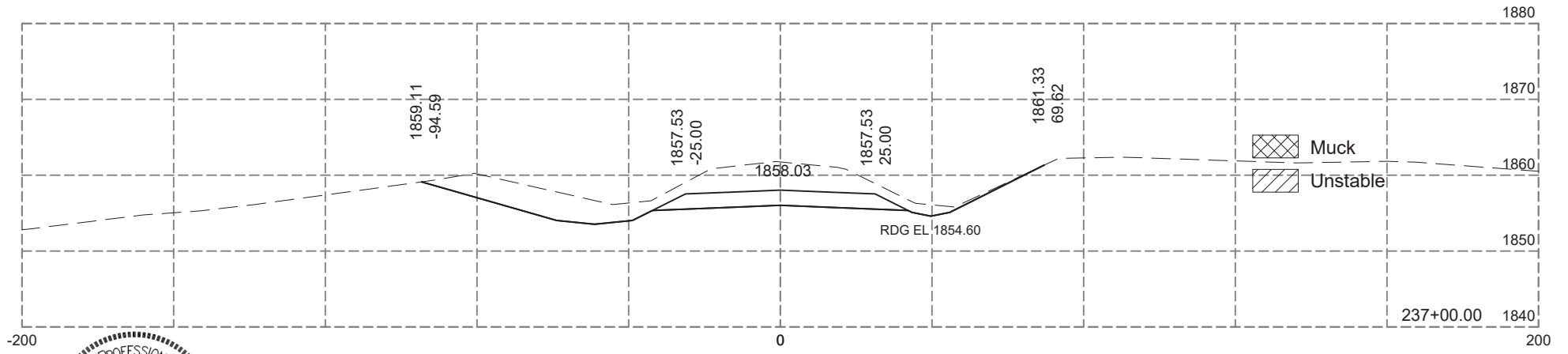
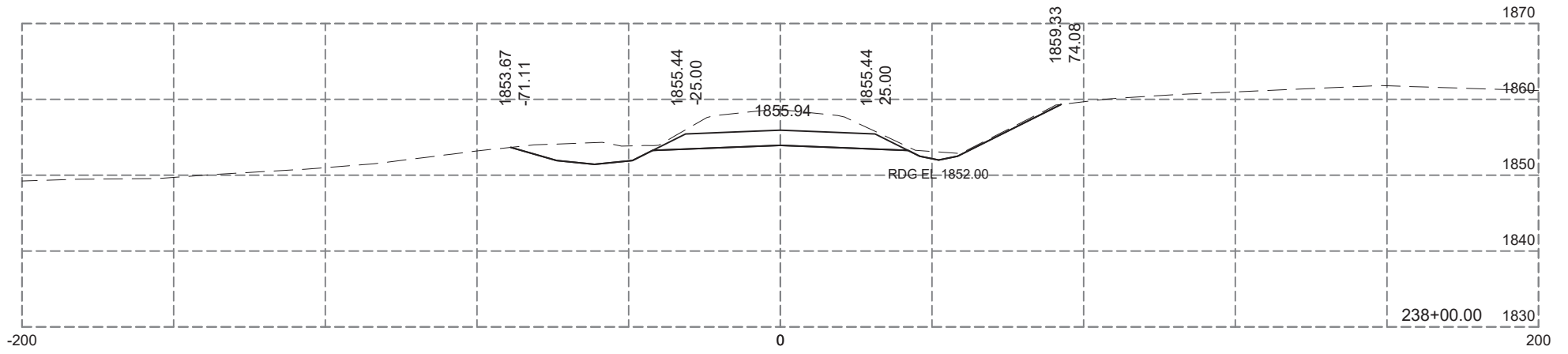
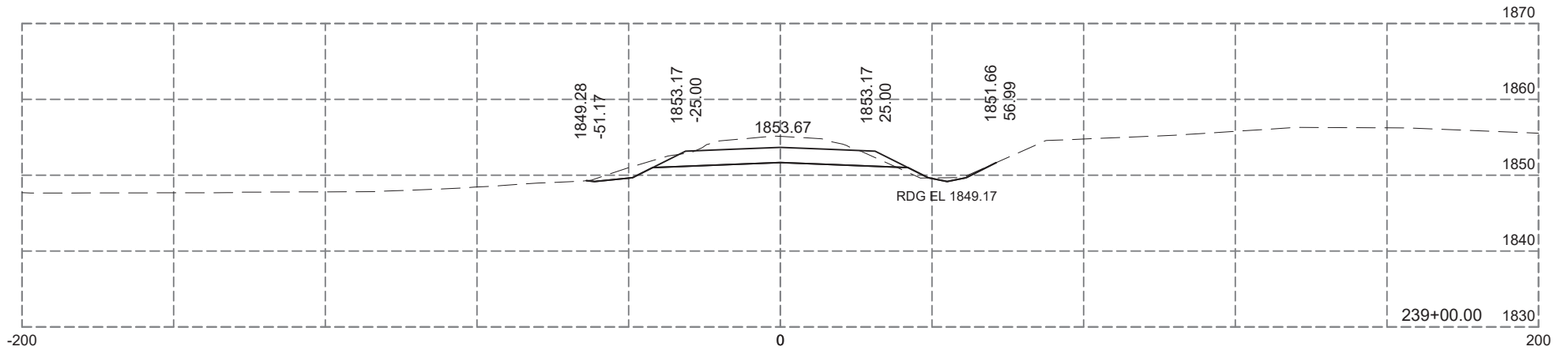
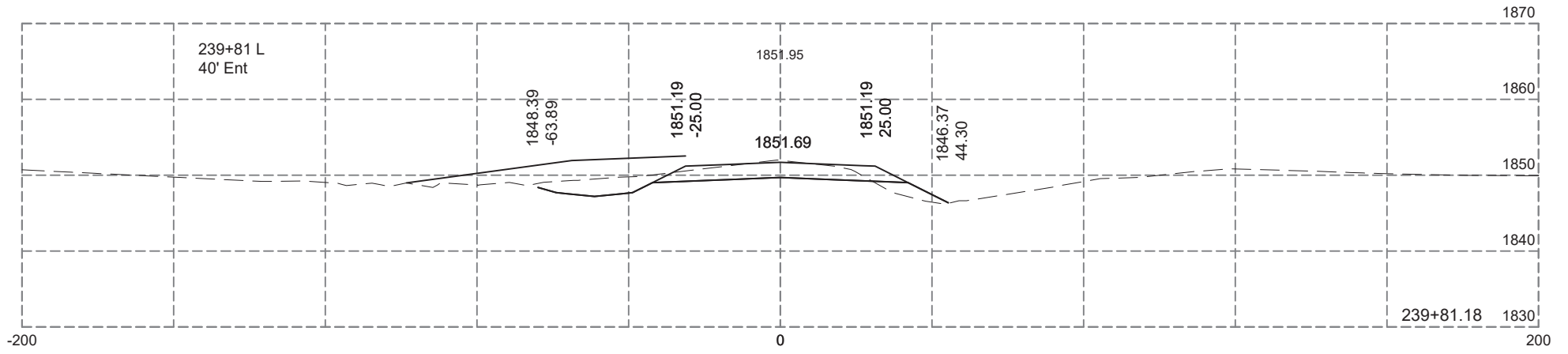
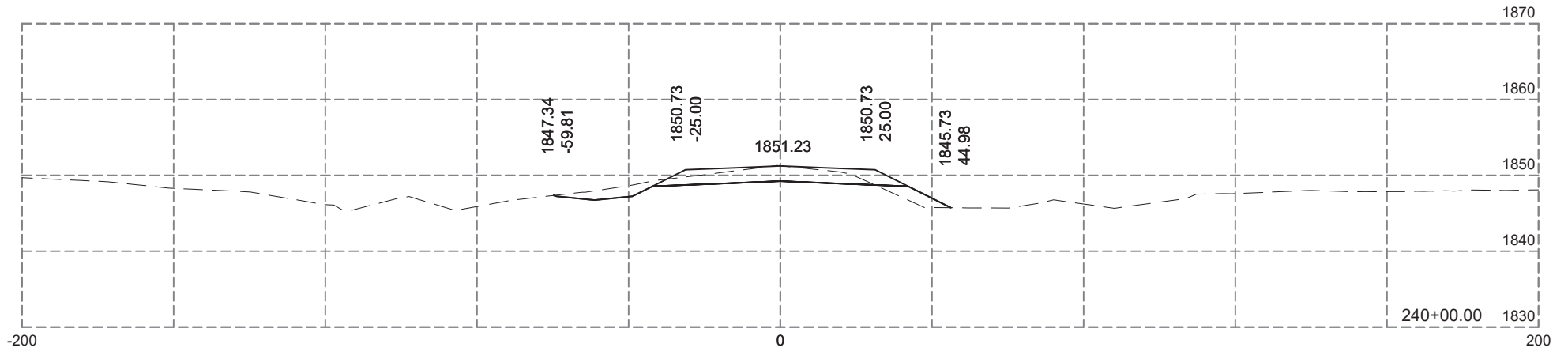
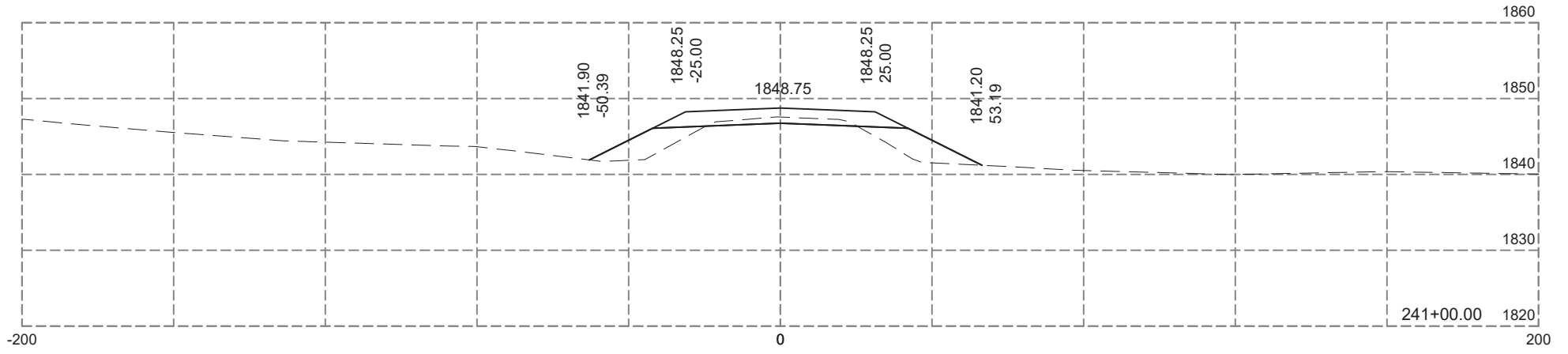

Plotting Date: 12-04-2024

STATE OF SOUTH DAKOTA	PROJECT P-PH-PT 0025(81)158	SHEET X56	TOTAL SHEETS X99
-----------------------	--------------------------------	--------------	---------------------



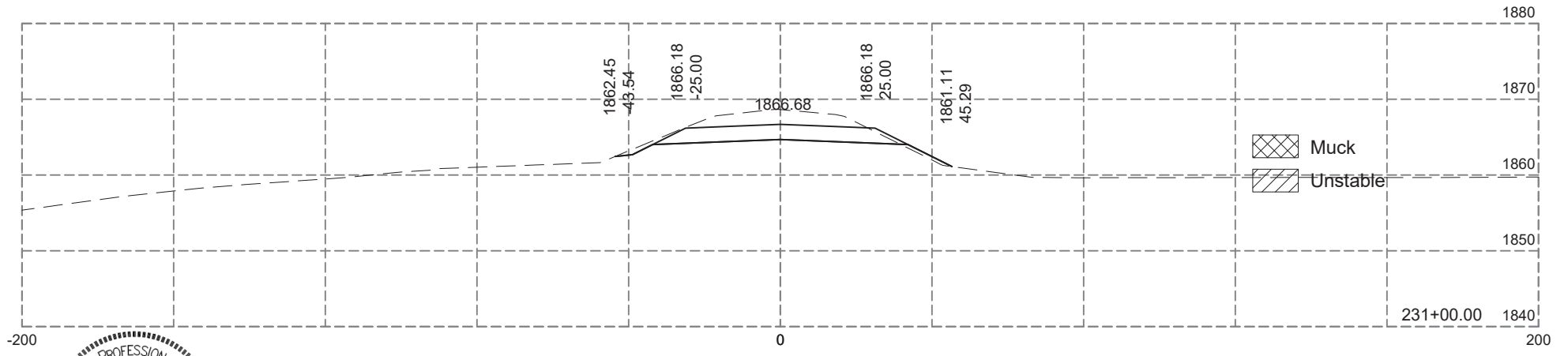
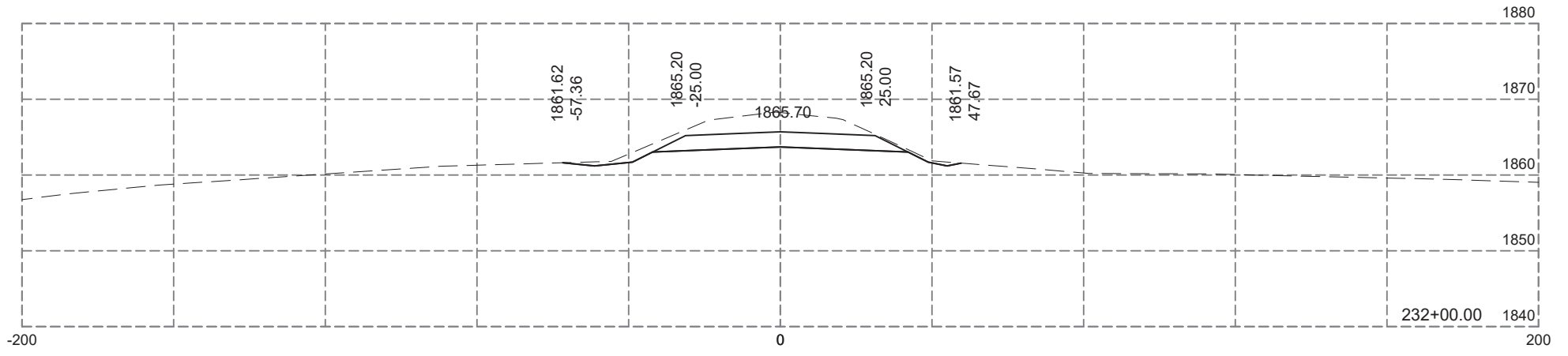
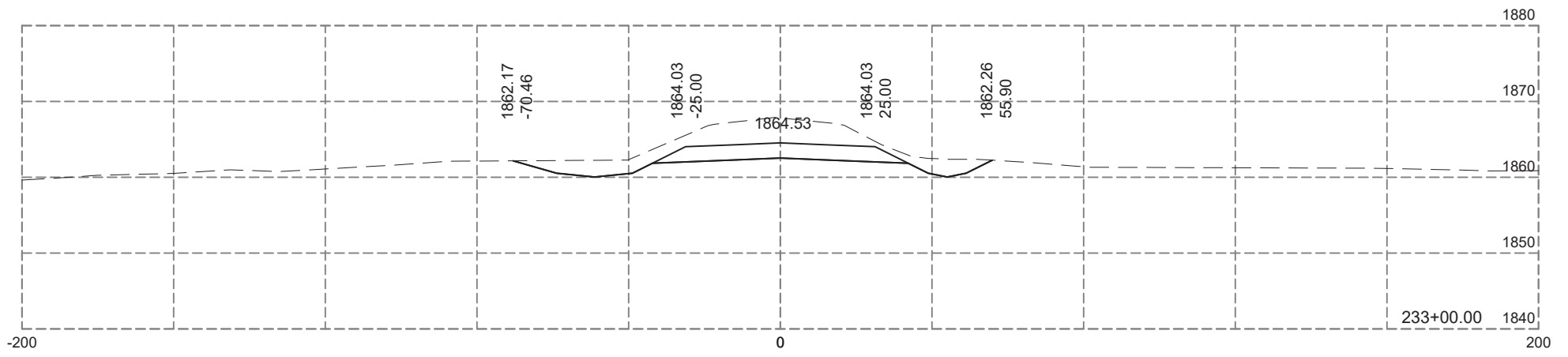
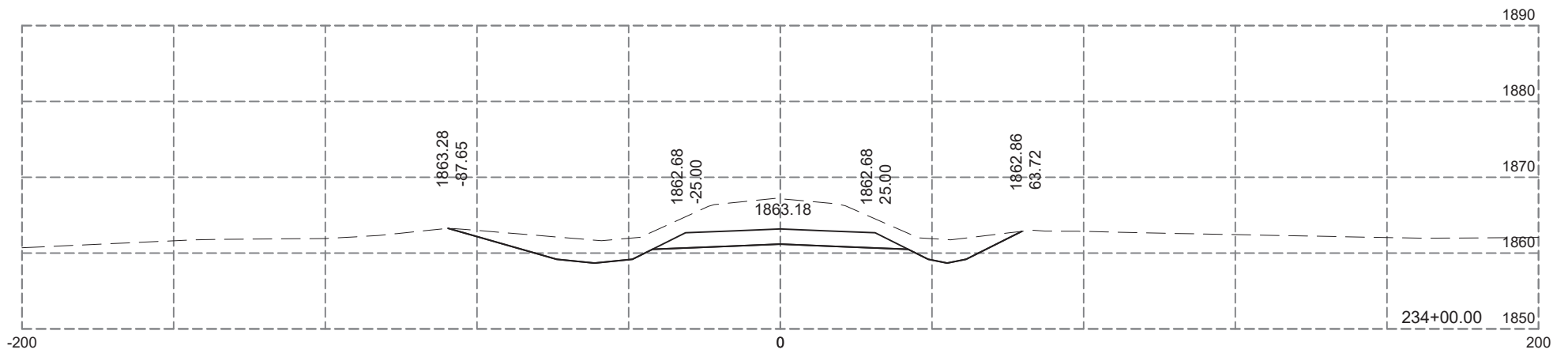
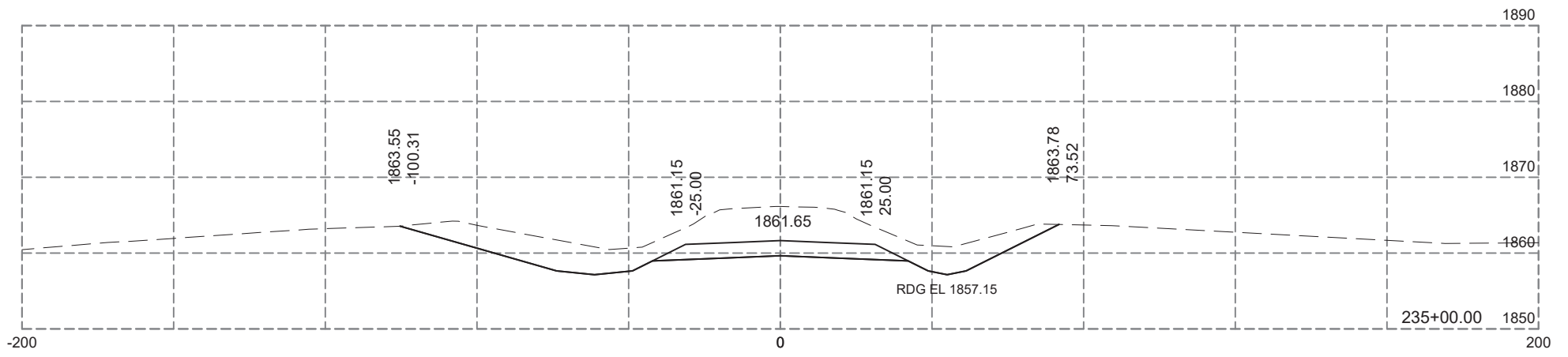
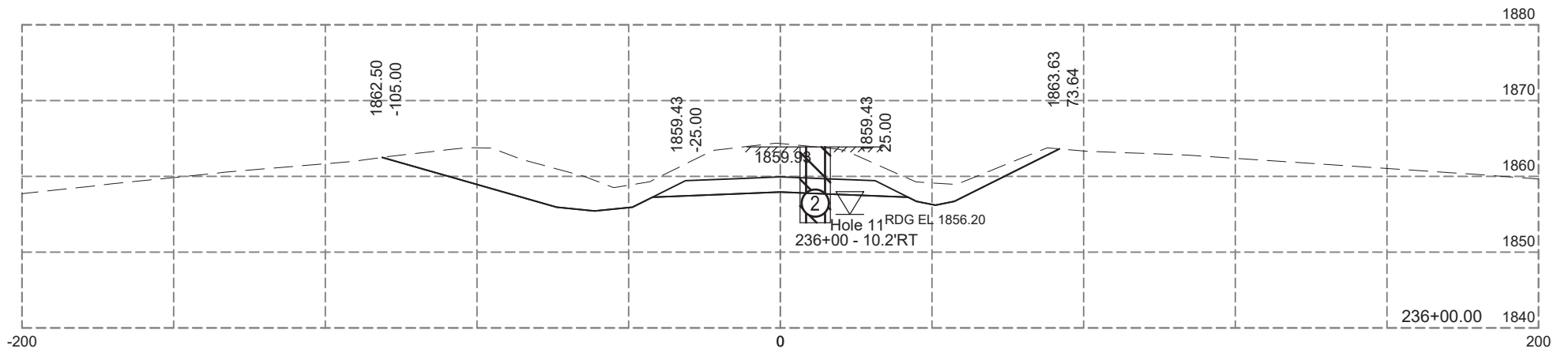

Plotting Date: 12-04-2024

STATE OF SOUTH DAKOTA	PROJECT P-PH-PT 0025(81)158	SHEET X57	TOTAL SHEETS X99
-----------------------	--------------------------------	--------------	---------------------

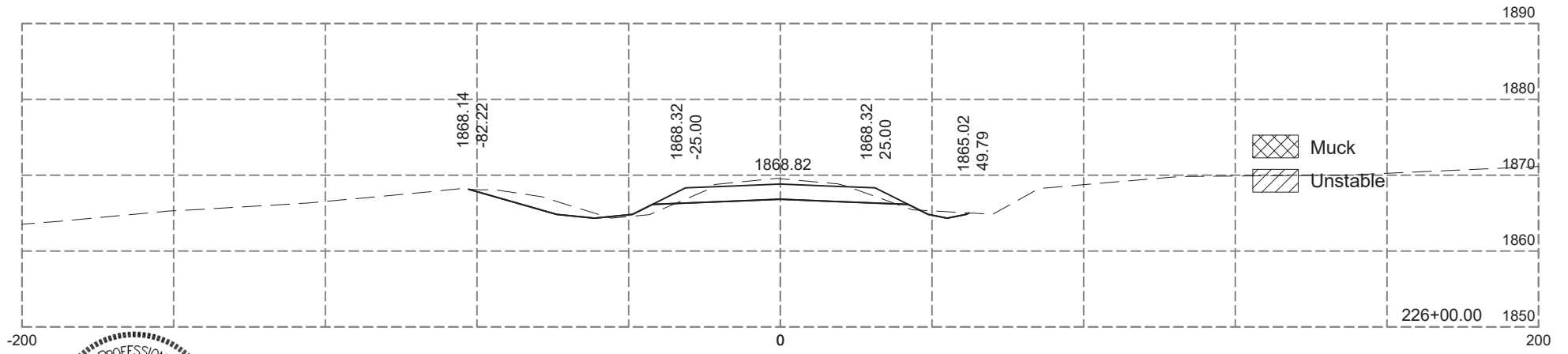
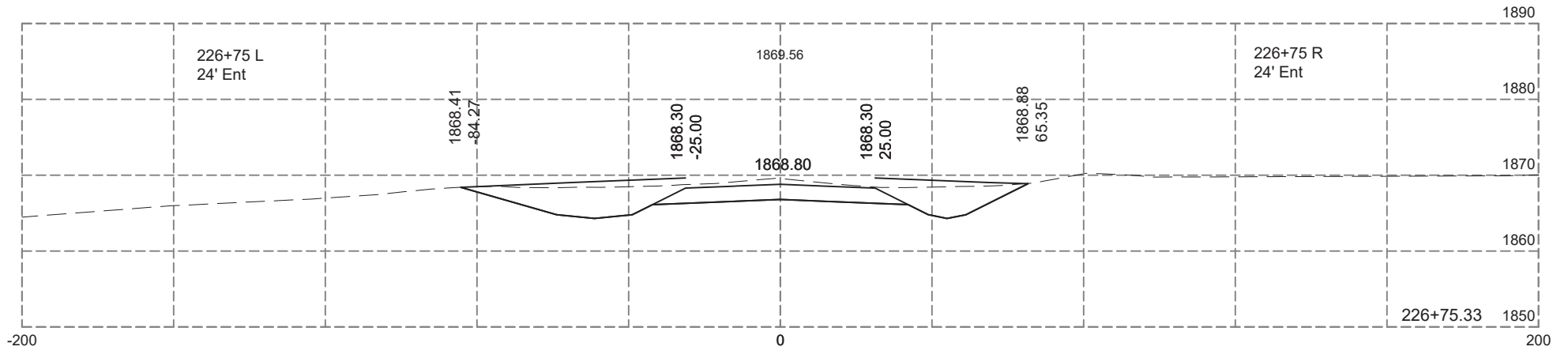
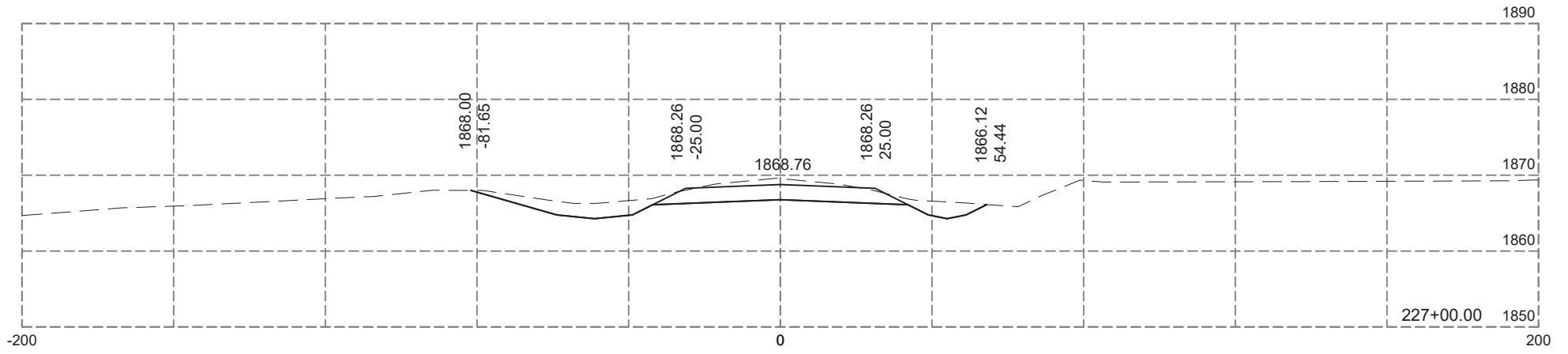
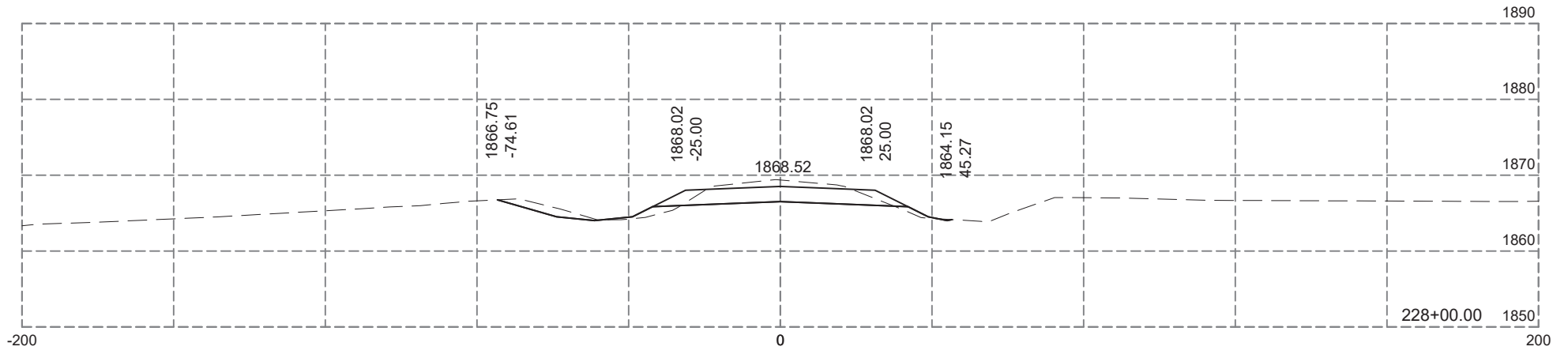
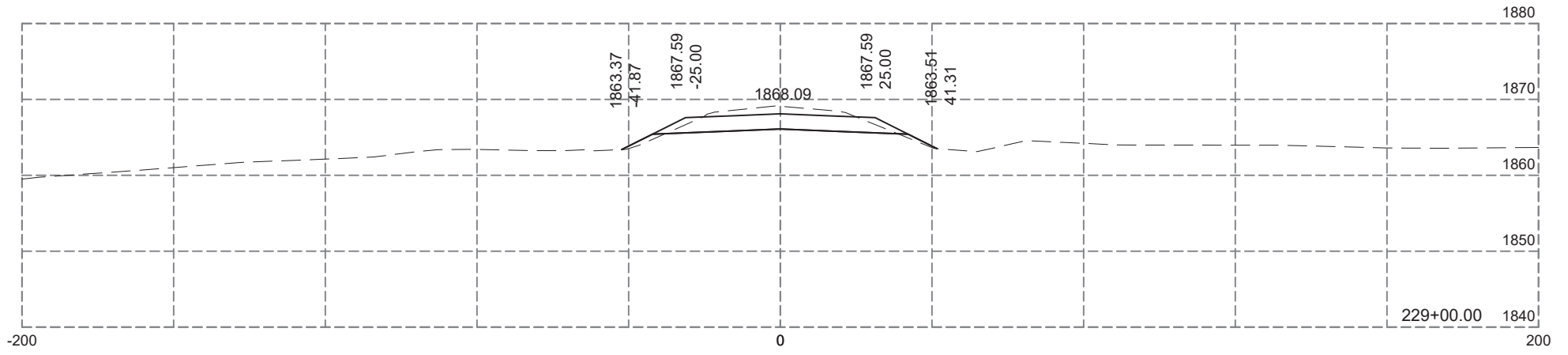
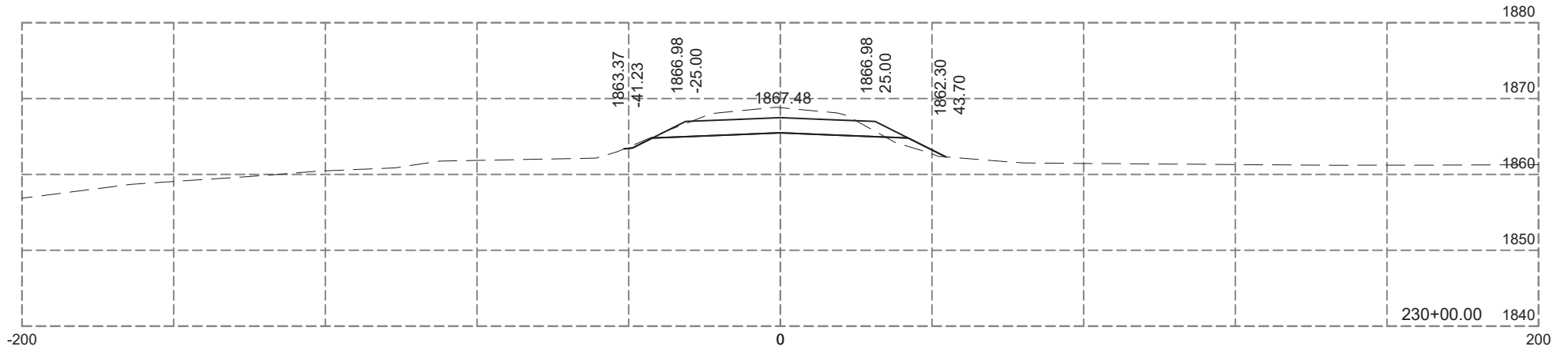

Plotting Date: 12-04-2024

STATE OF SOUTH DAKOTA	PROJECT	SHEET	TOTAL SHEETS
	P-PH-PT 0025(81)158	X58	X99

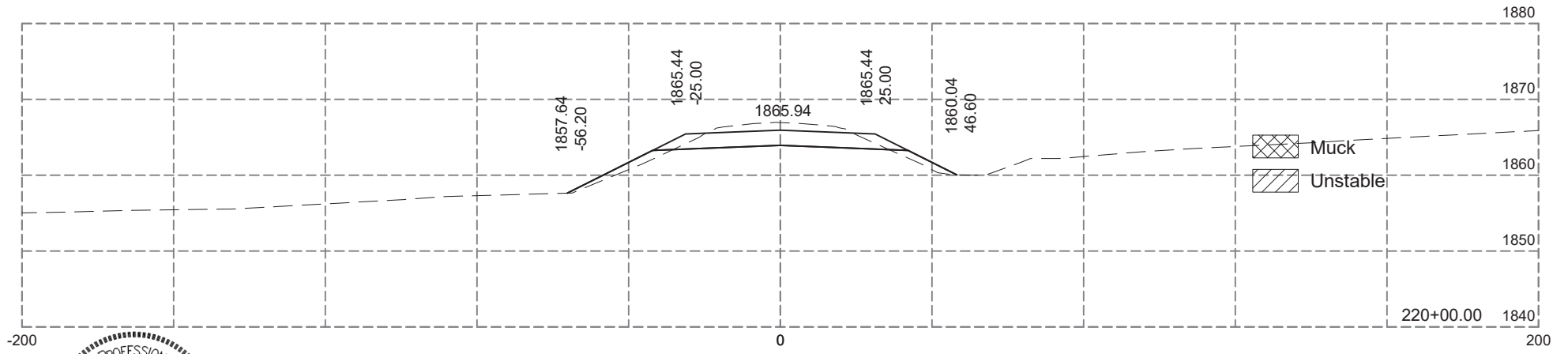
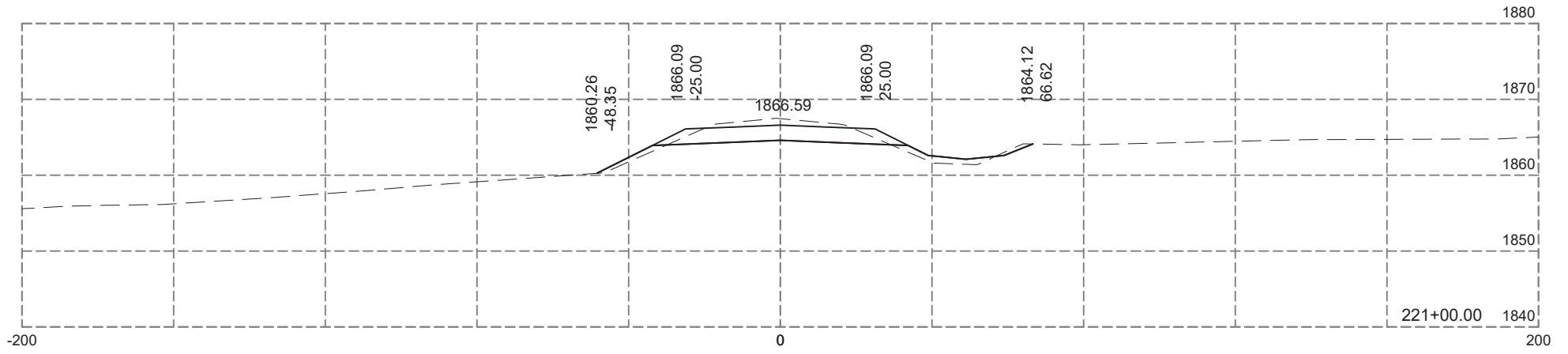
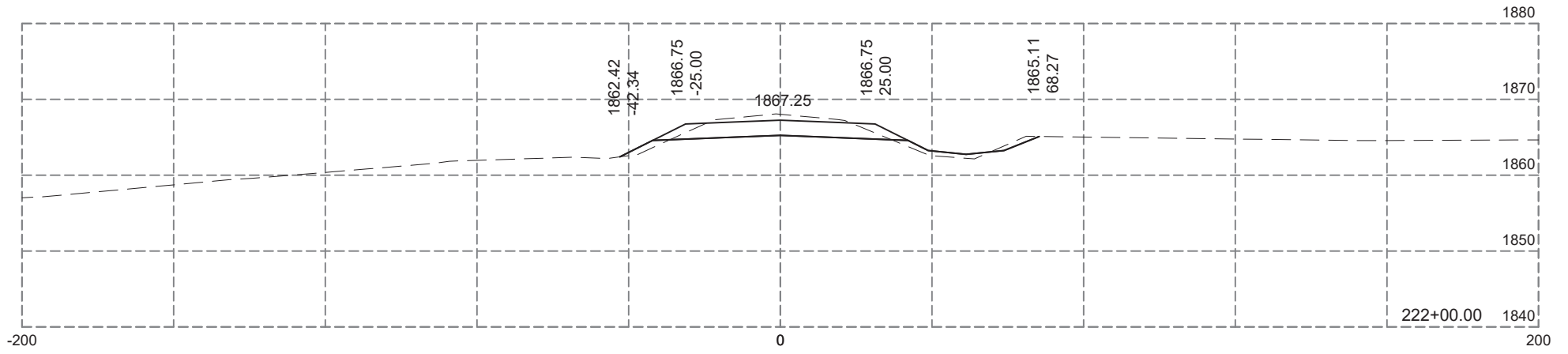
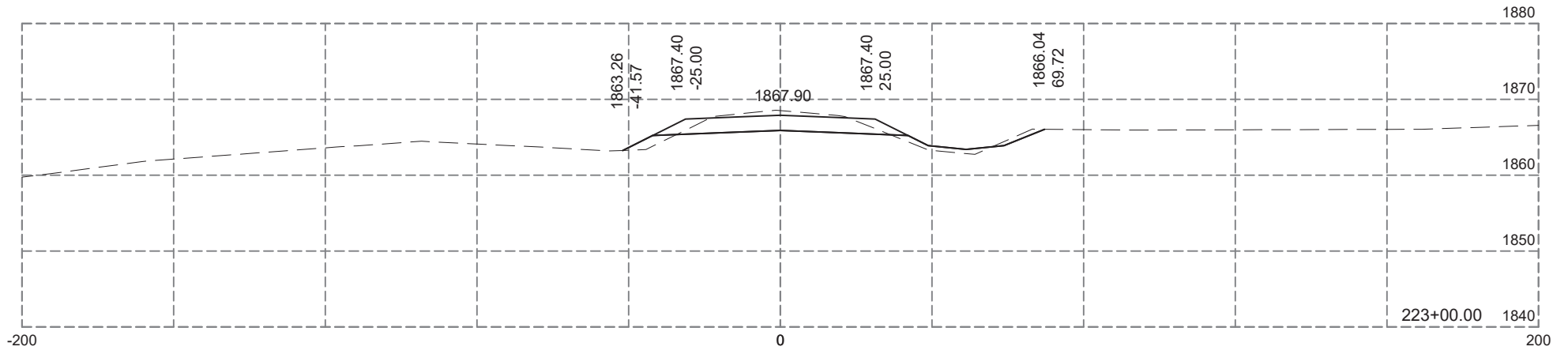
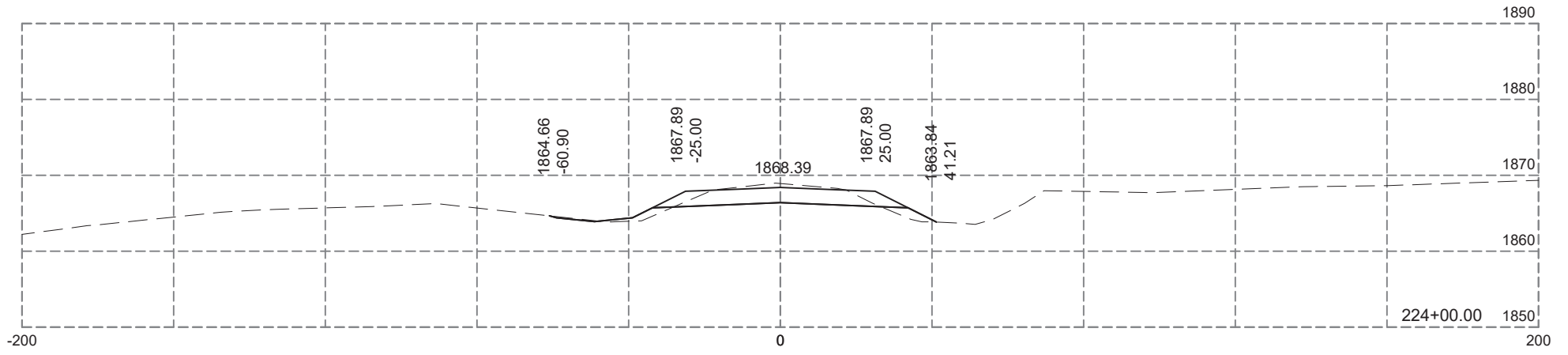
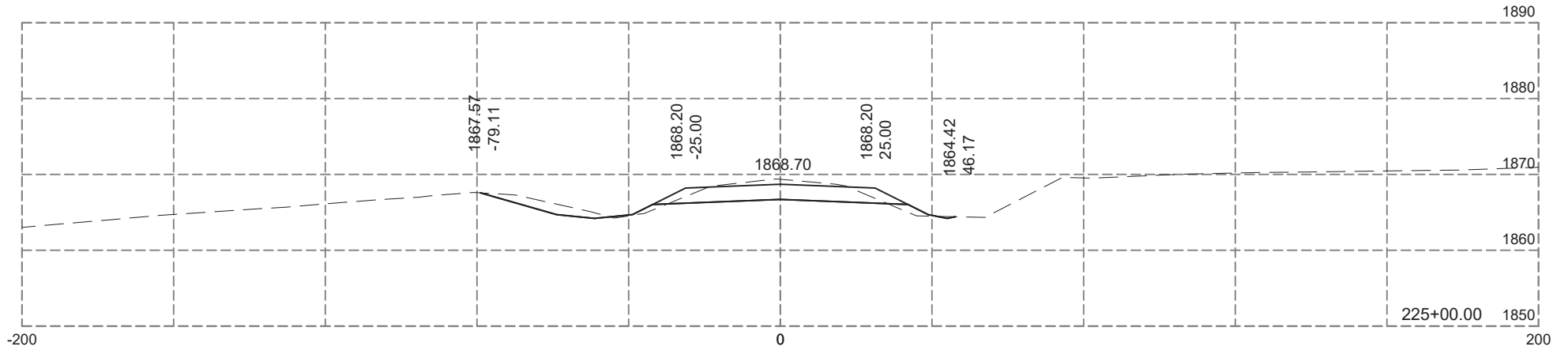

Plotting Date: 12-04-2024

STATE OF SOUTH DAKOTA	PROJECT P-PH-PT 0025(81)158	SHEET X59	TOTAL SHEETS X99
-----------------------	--------------------------------	--------------	---------------------

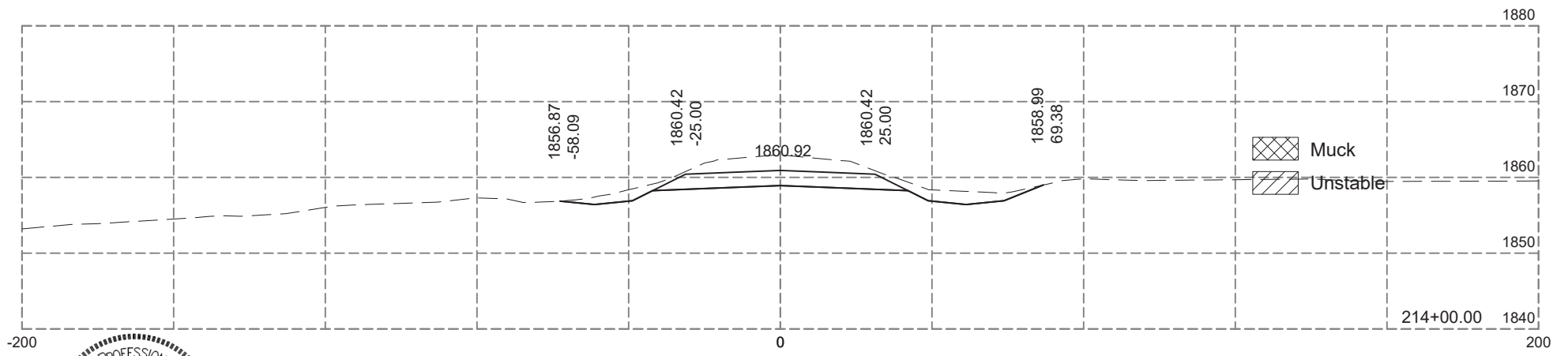
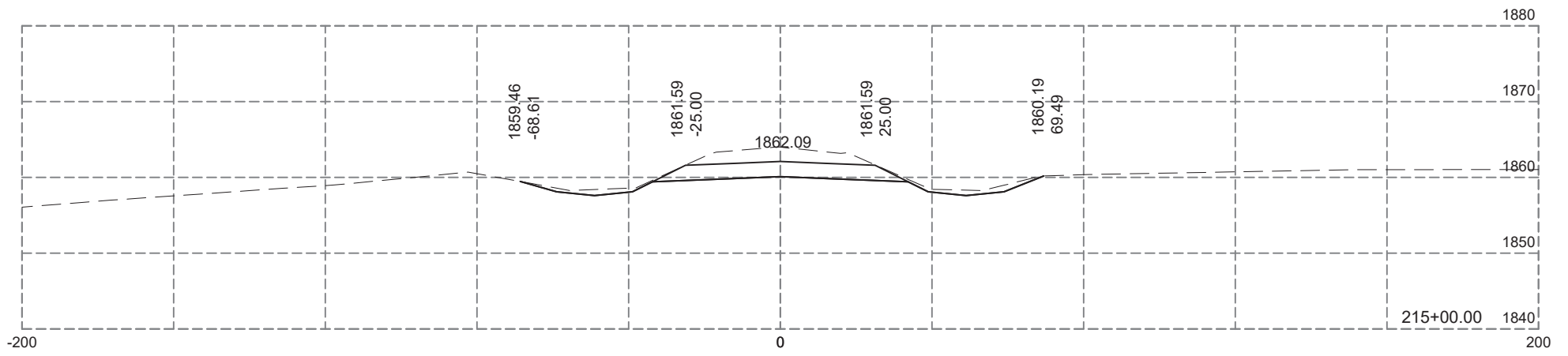
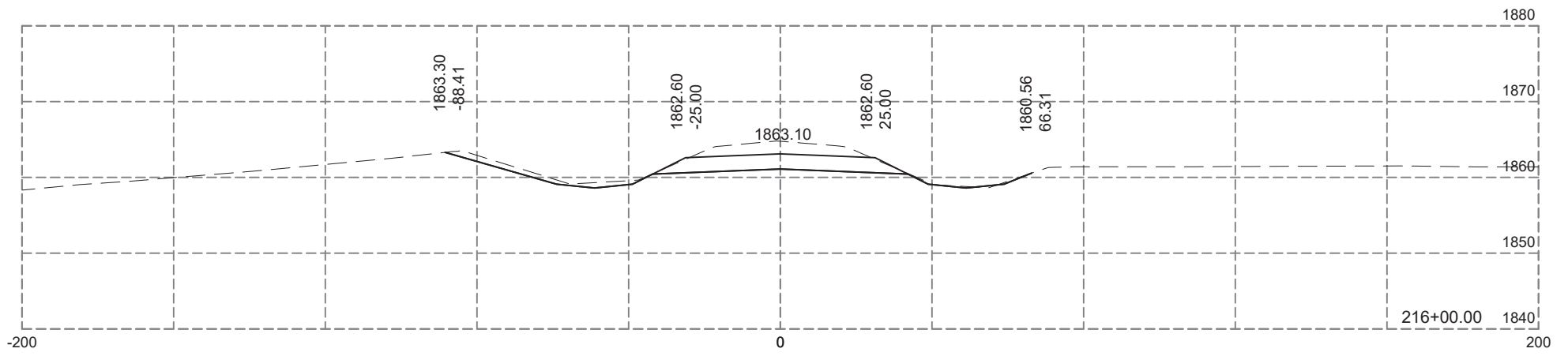
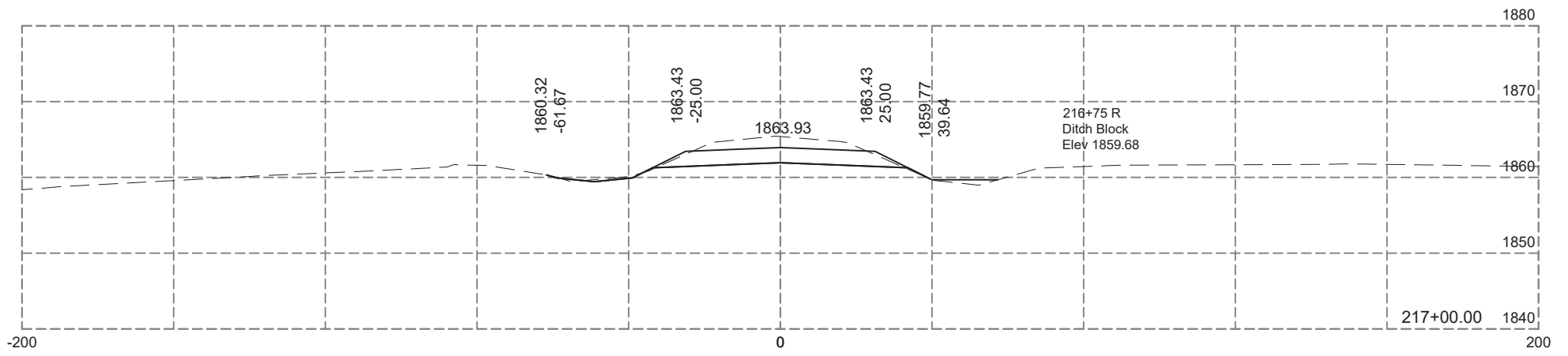
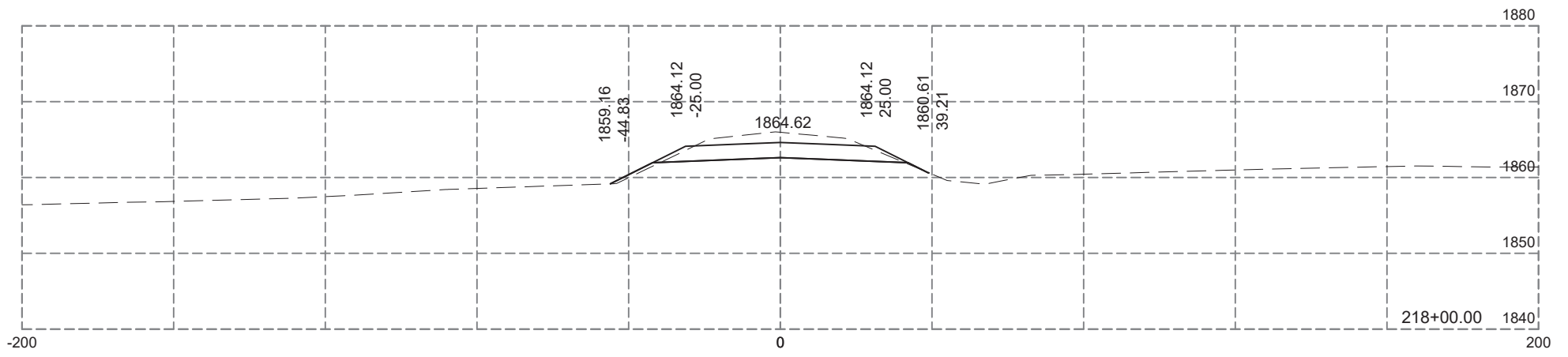
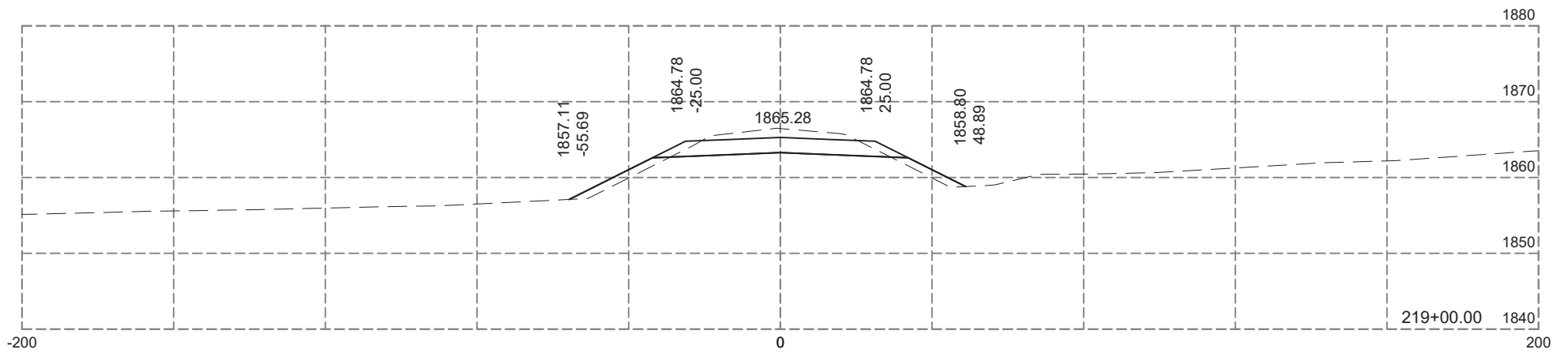

Plotting Date: 12-04-2024

STATE OF SOUTH DAKOTA	PROJECT	SHEET	TOTAL SHEETS
	P-PH-PT 0025(81)158	X60	X99

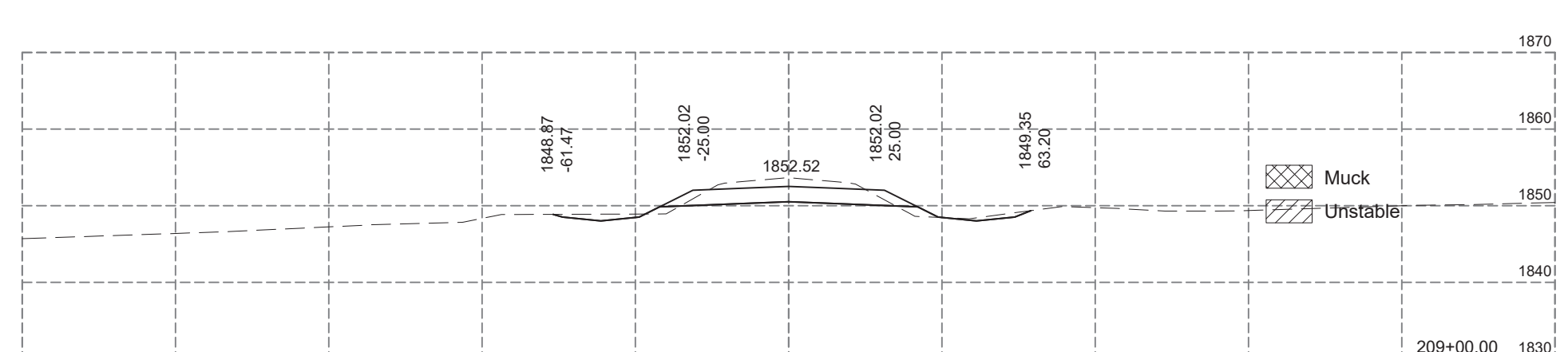
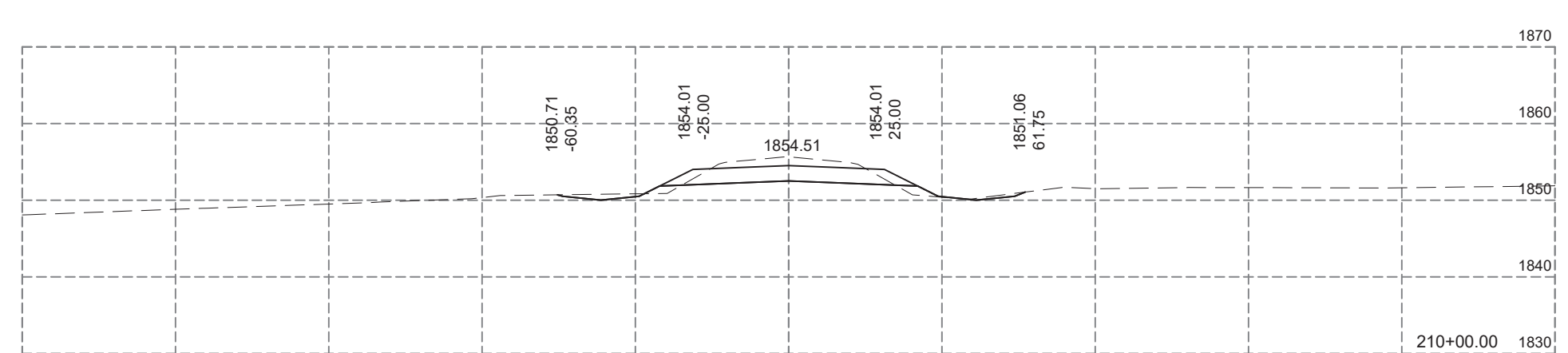
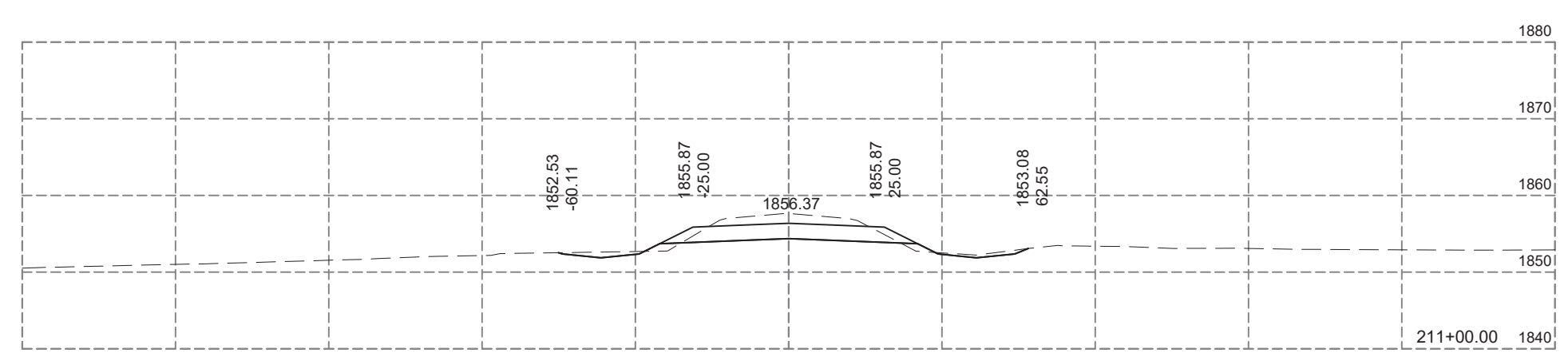
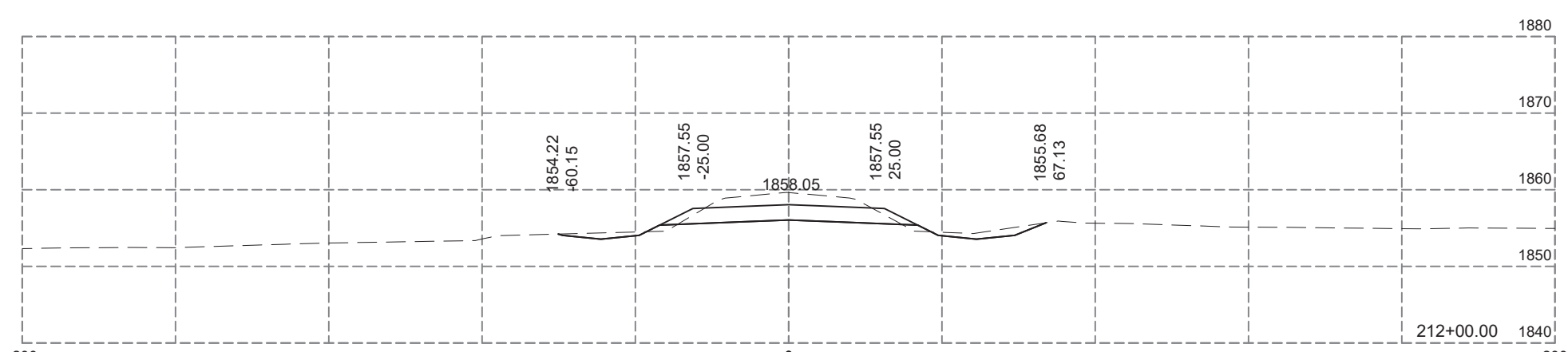
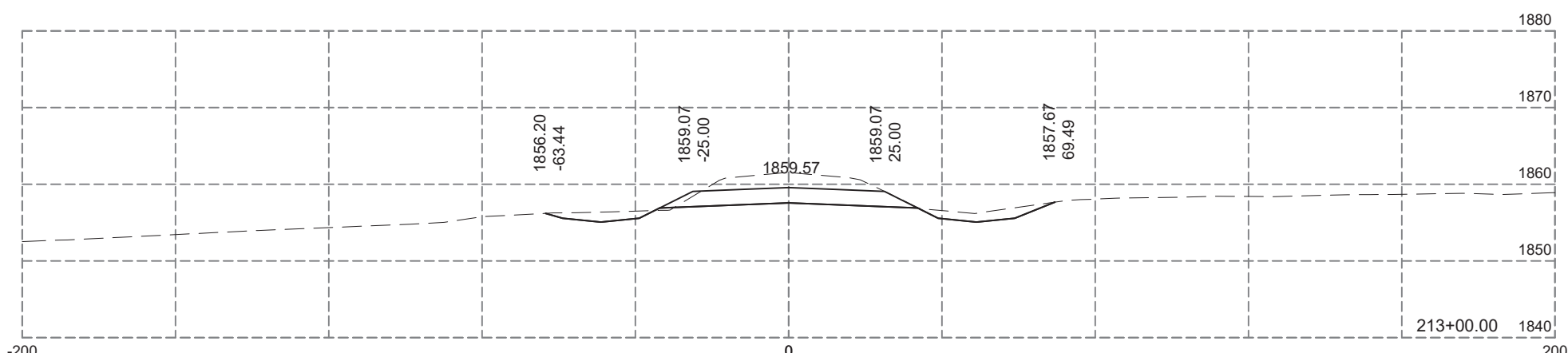
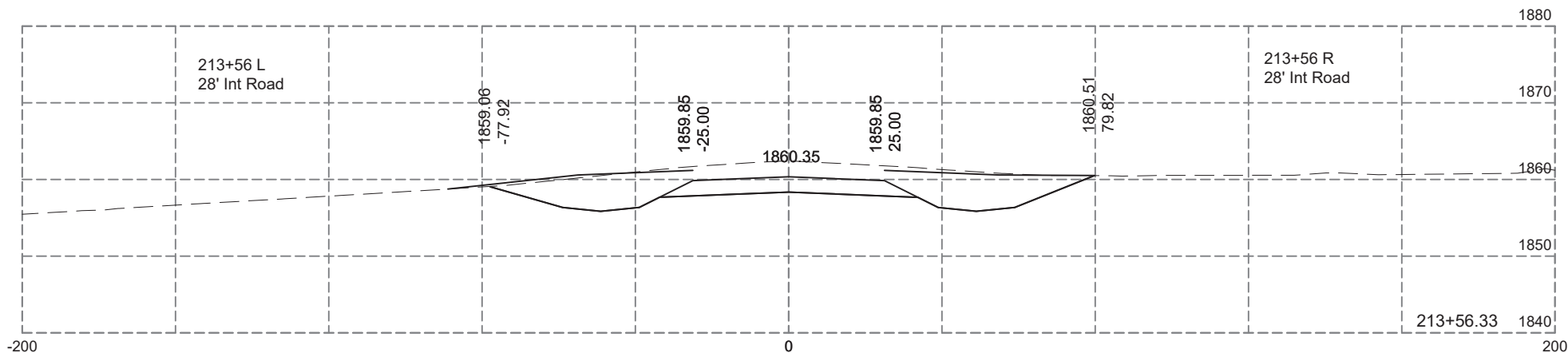

Plotting Date: 12-04-2024

STATE OF SOUTH DAKOTA	PROJECT	SHEET	TOTAL SHEETS
	P-PH-PT 0025(81)158	X61	X99

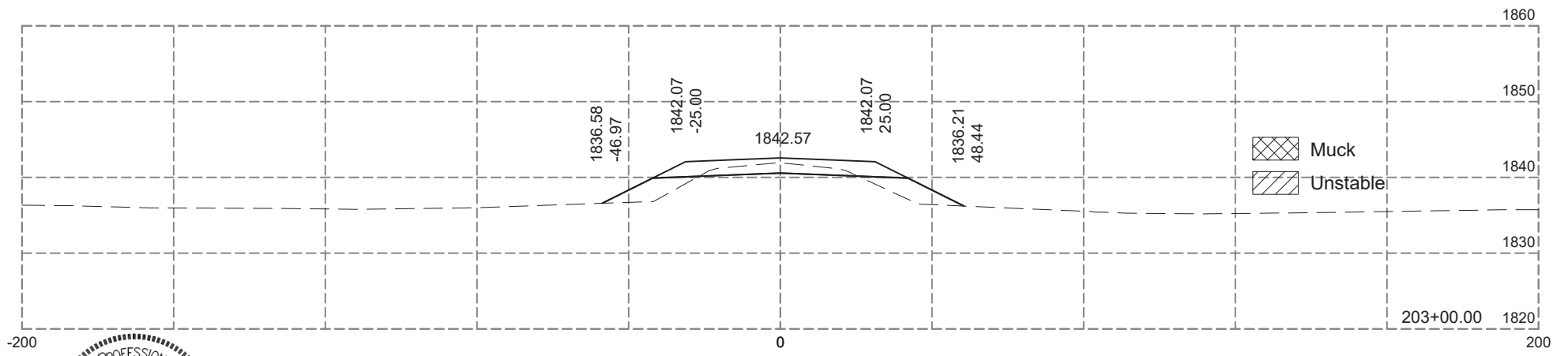
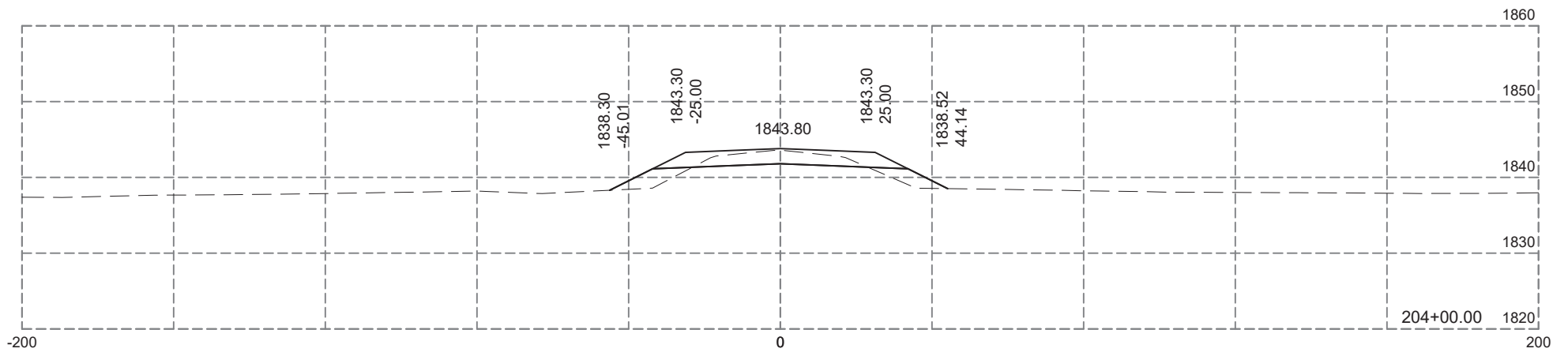
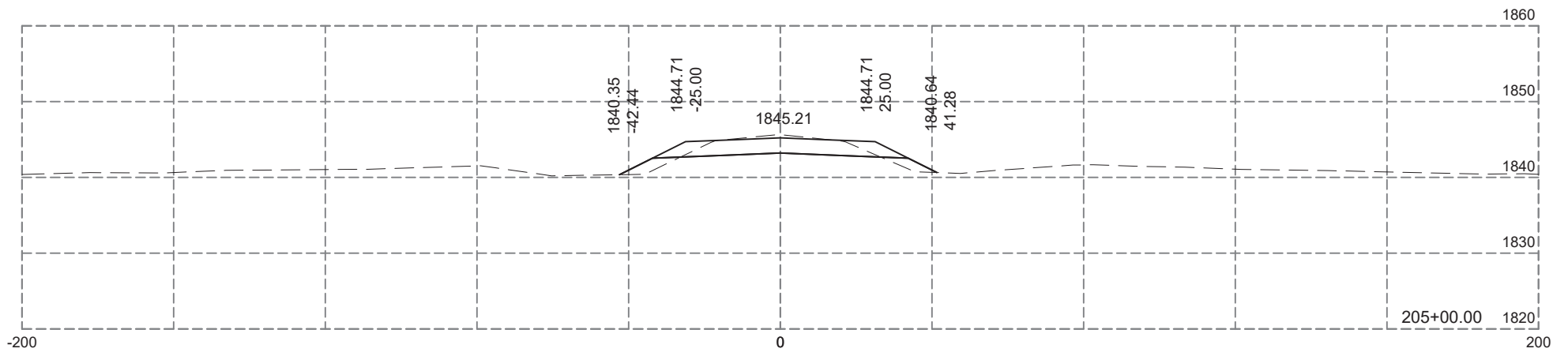
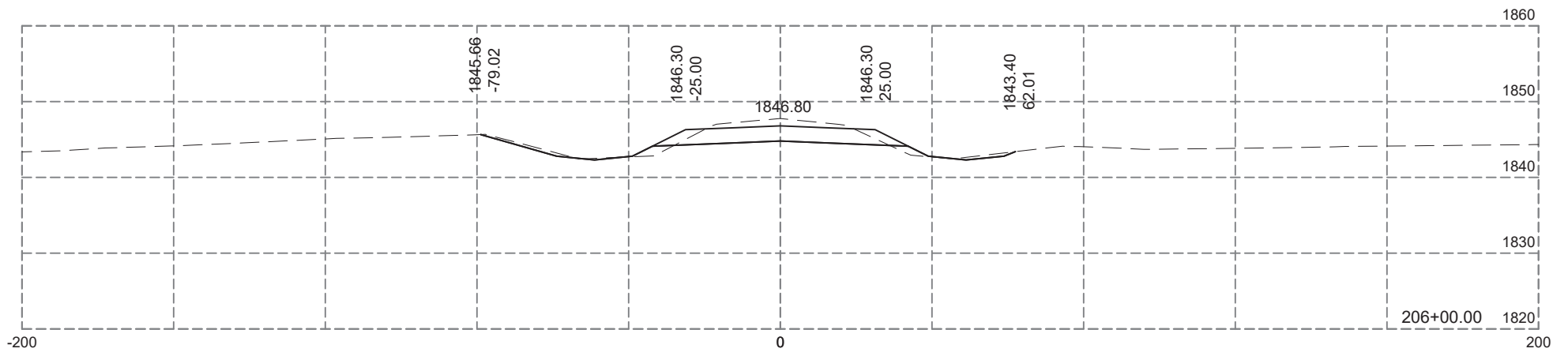
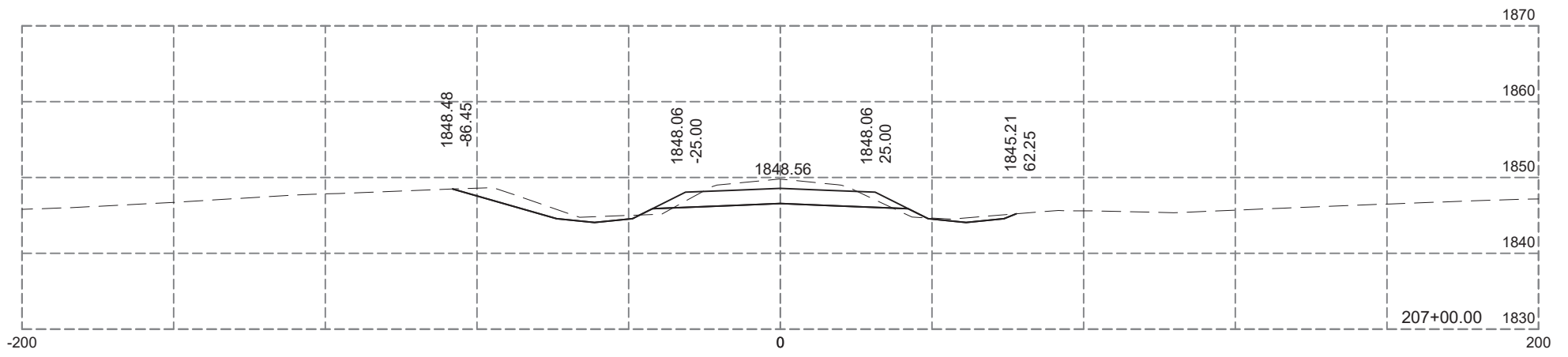
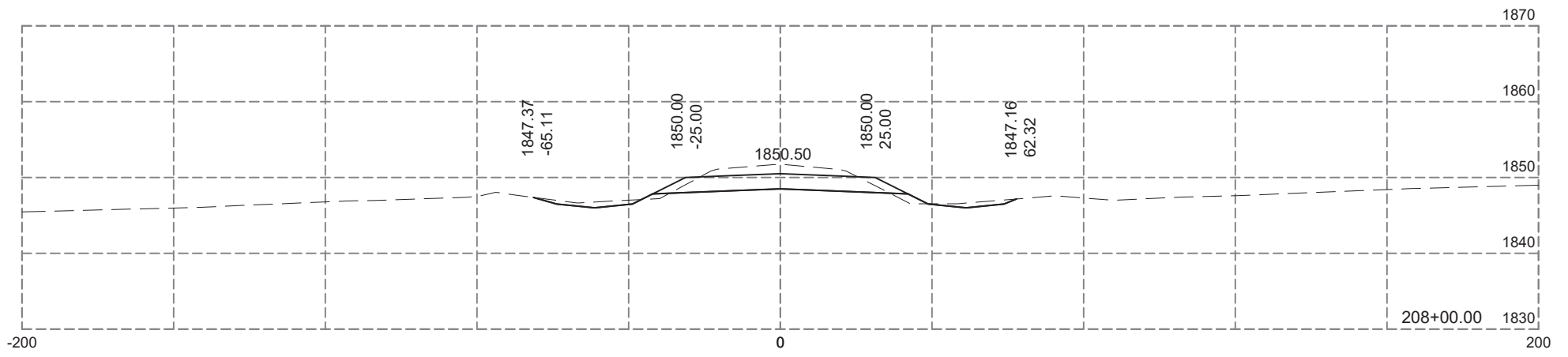

Plotting Date: 12-04-2024

STATE OF SOUTH DAKOTA	PROJECT	SHEET	TOTAL SHEETS
	P-PH-PT 0025(81)158	X62	X99

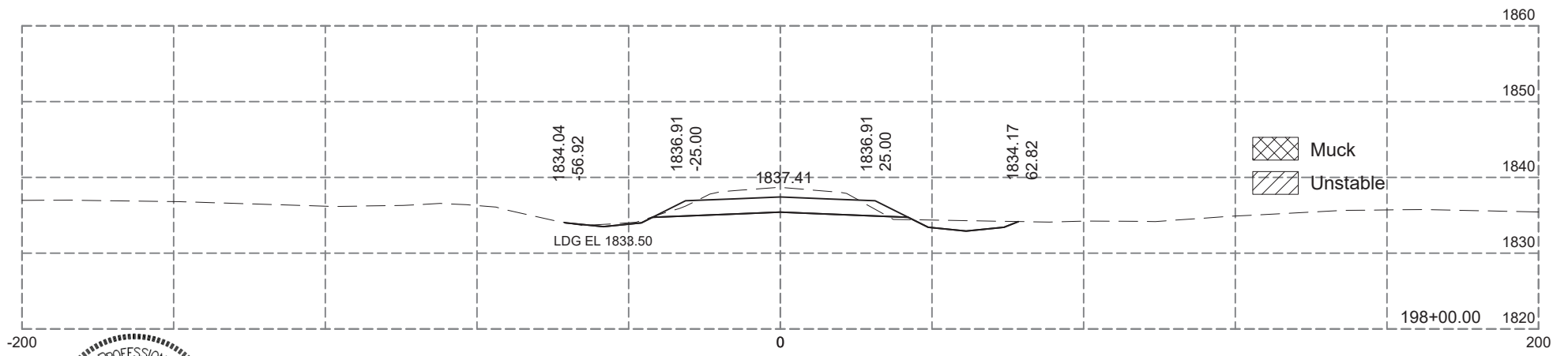
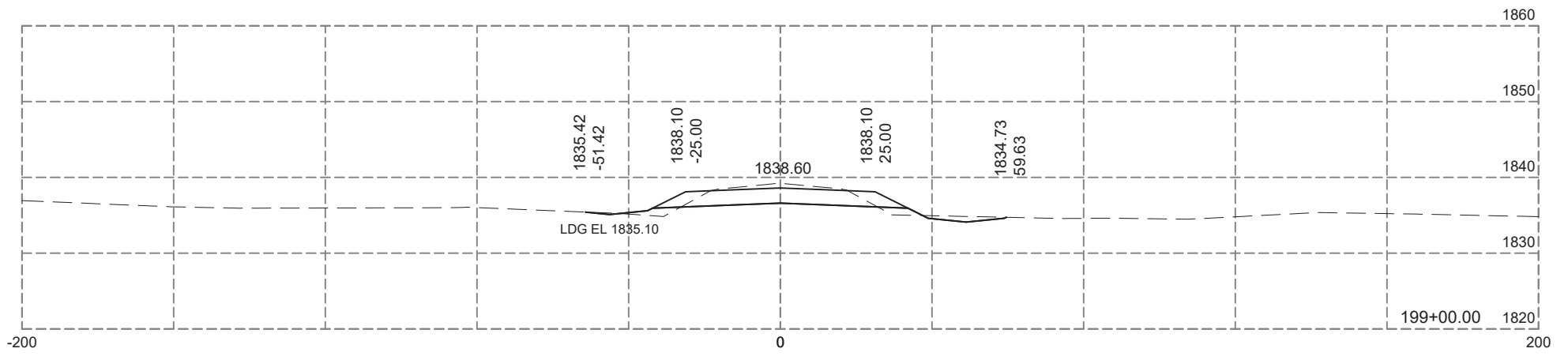
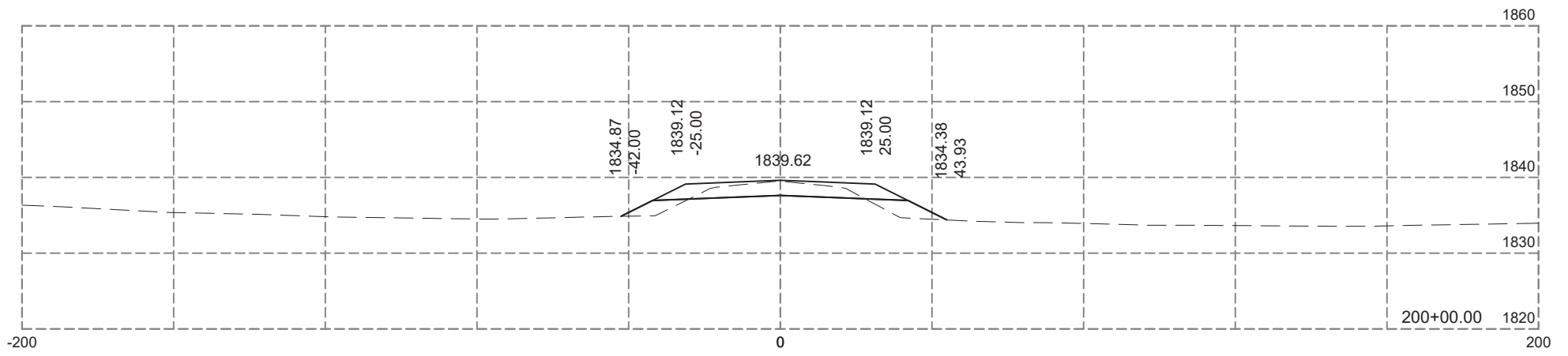
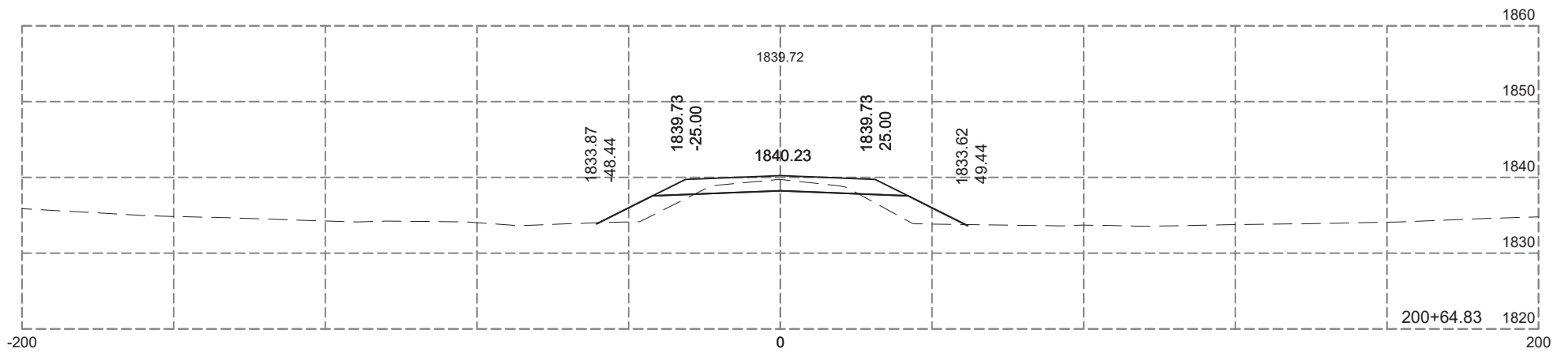
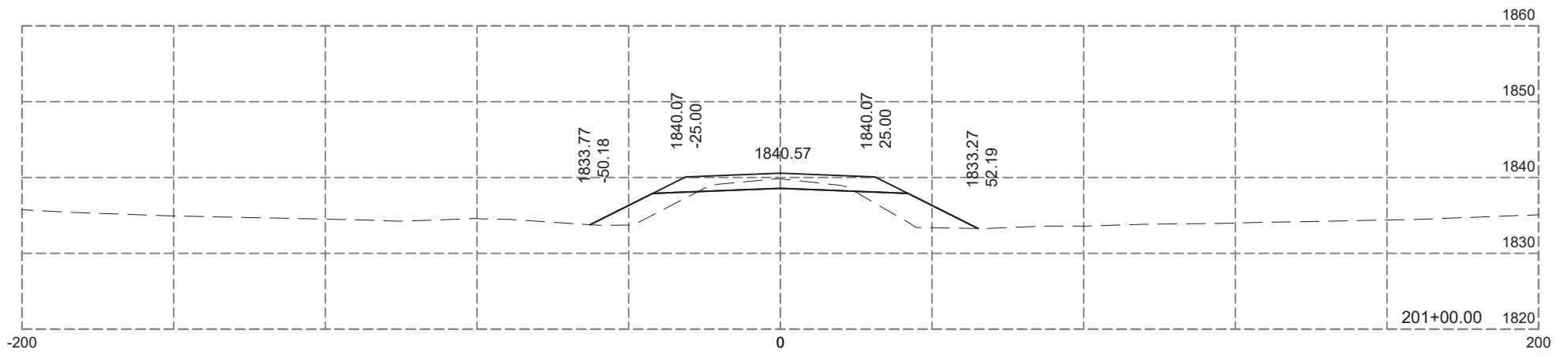
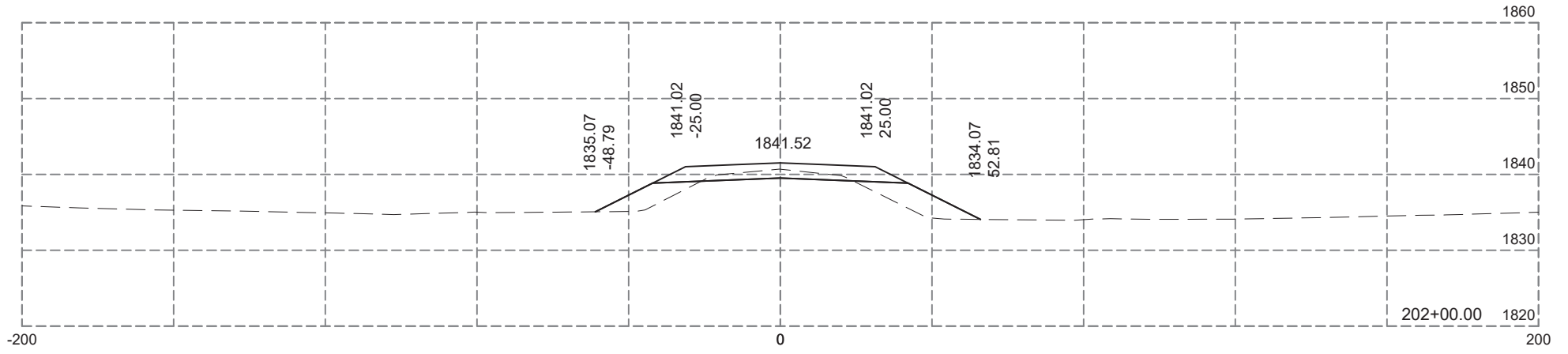

Plotting Date: 12-04-2024

STATE OF SOUTH DAKOTA	PROJECT	SHEET	TOTAL SHEETS
	P-PH-PT 0025(81)158	X63	X99

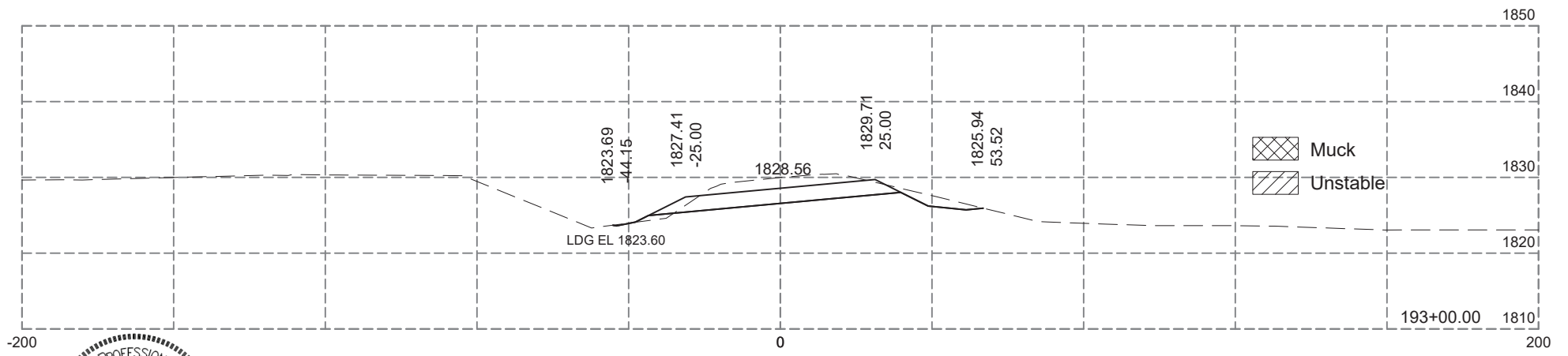
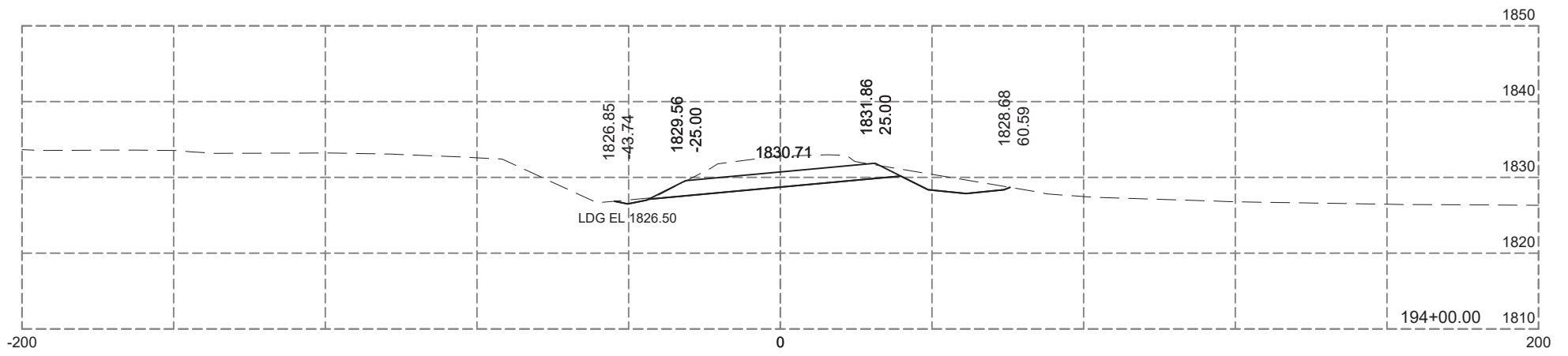
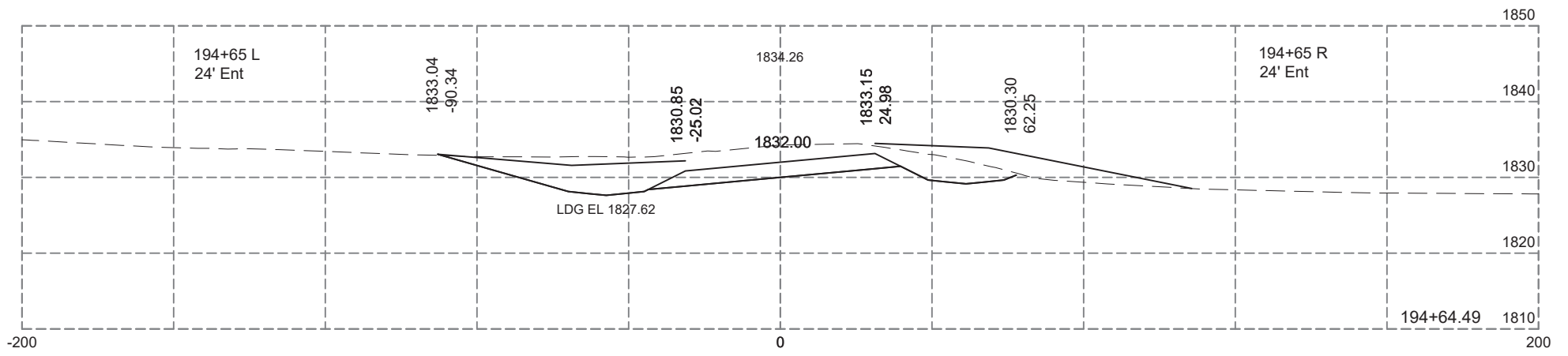
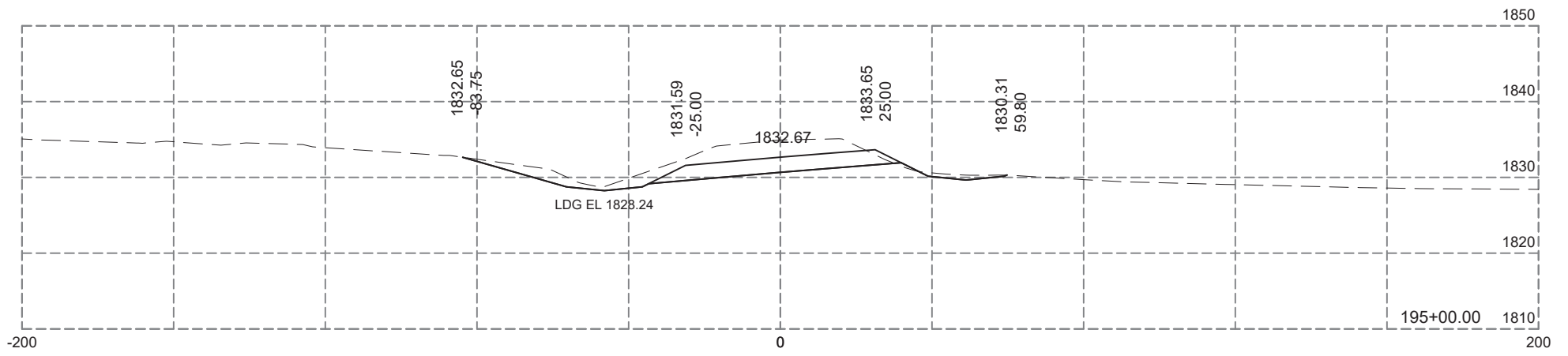
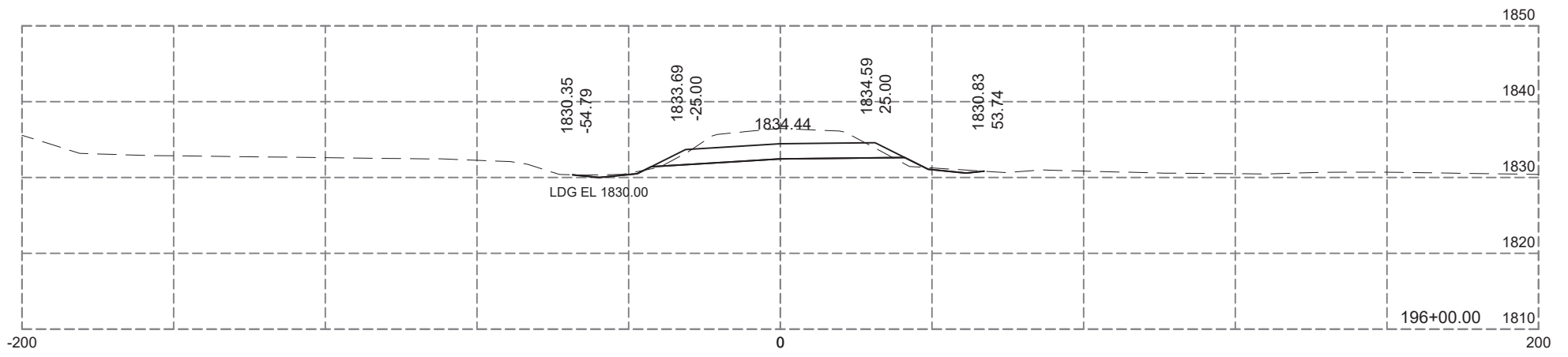
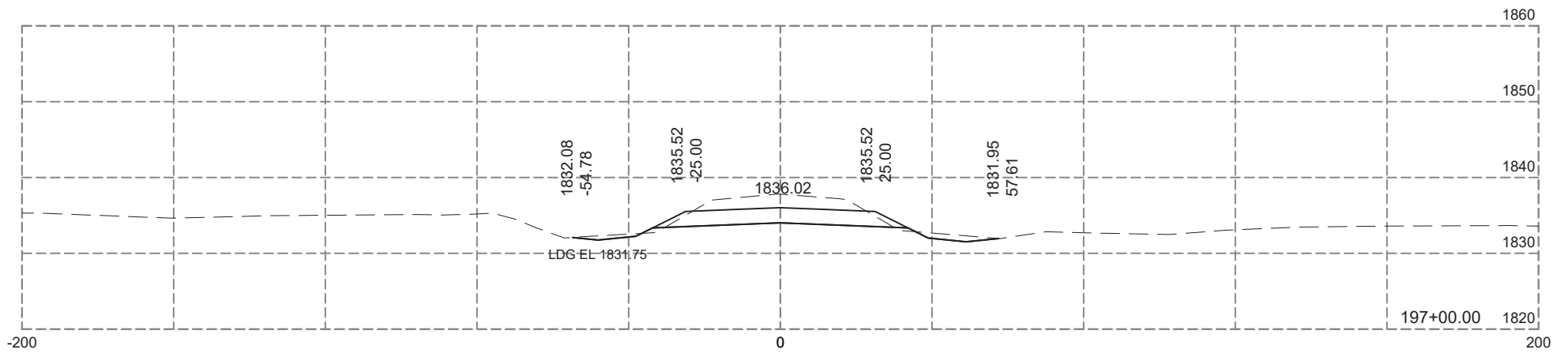

Plotting Date: 12-04-2024

STATE OF SOUTH DAKOTA	PROJECT P-PH-PT 0025(81)158	SHEET X64	TOTAL SHEETS X99
-----------------------	--------------------------------	--------------	---------------------



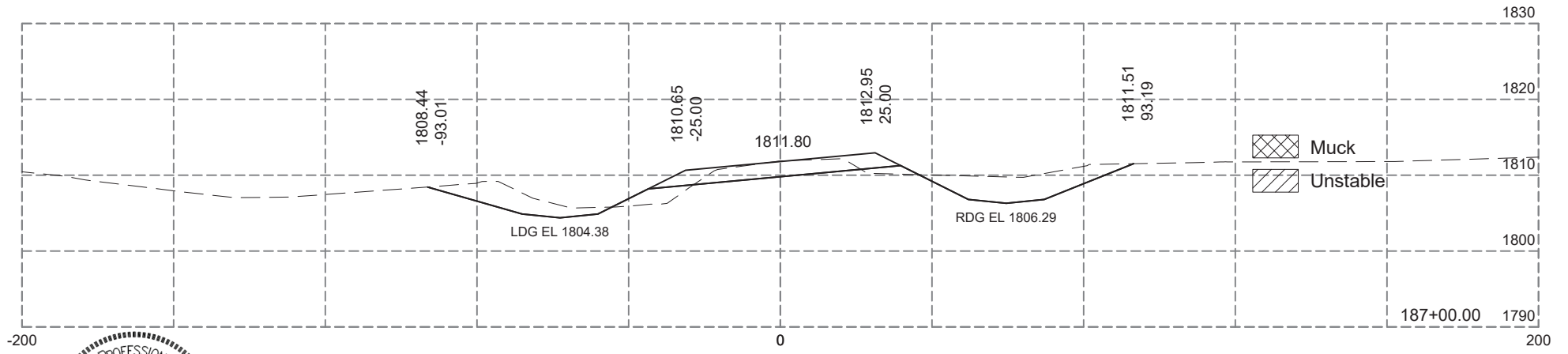
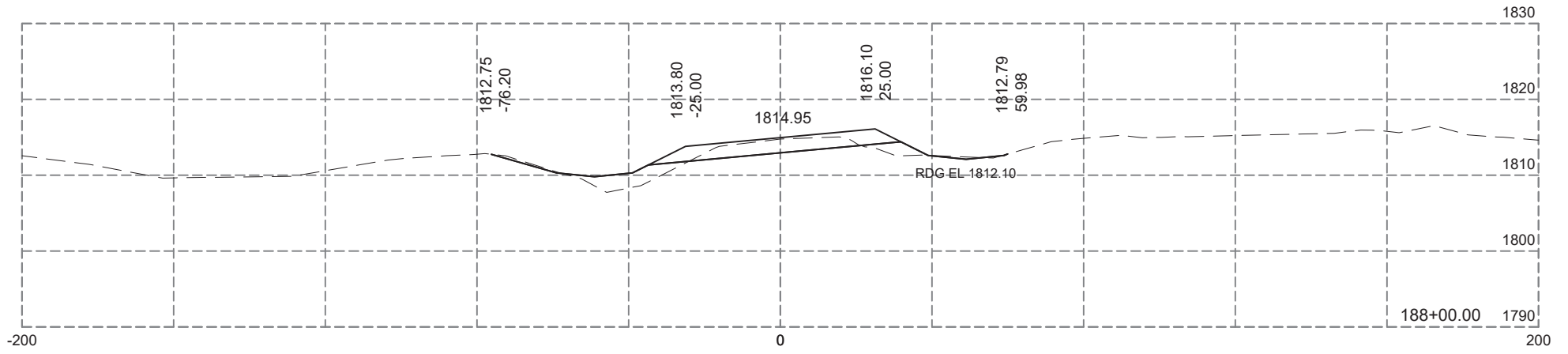
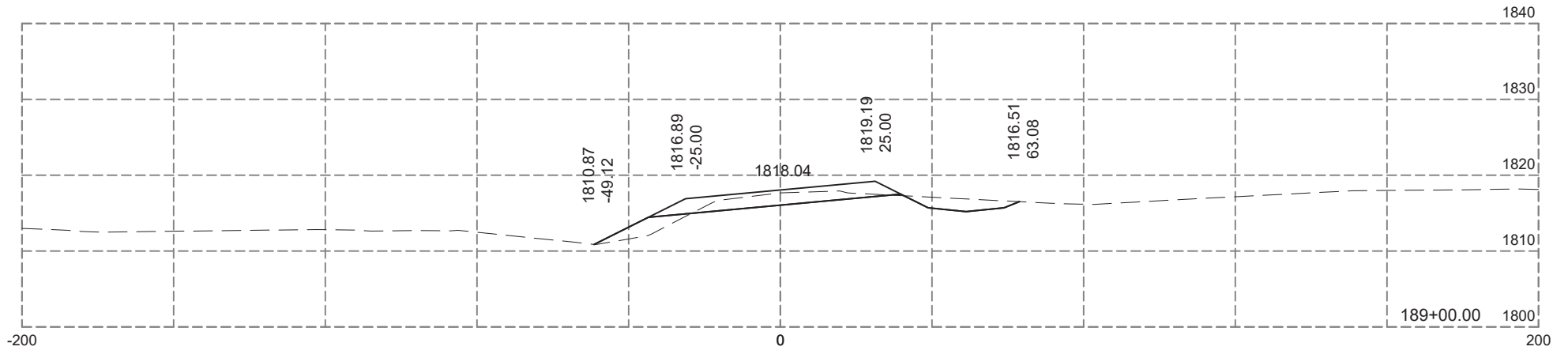
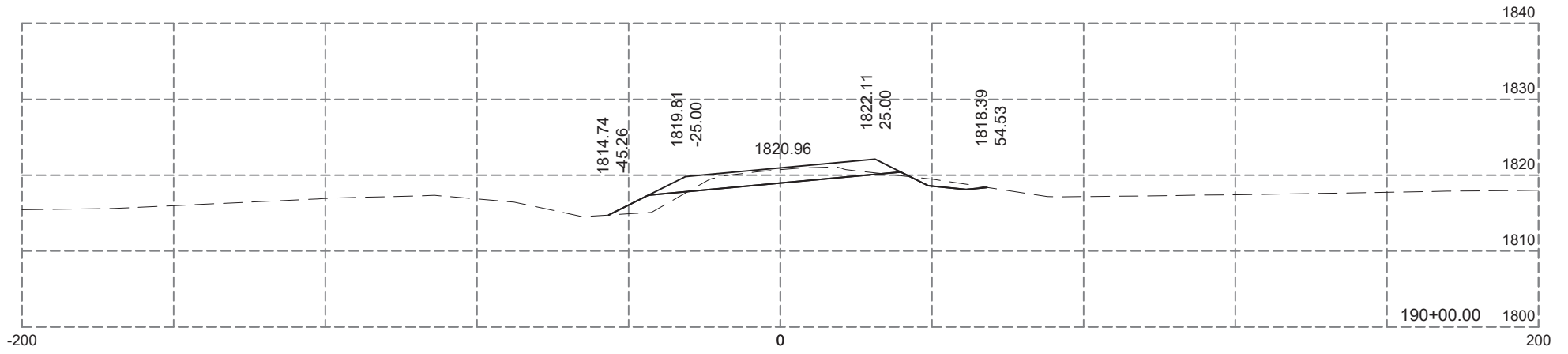
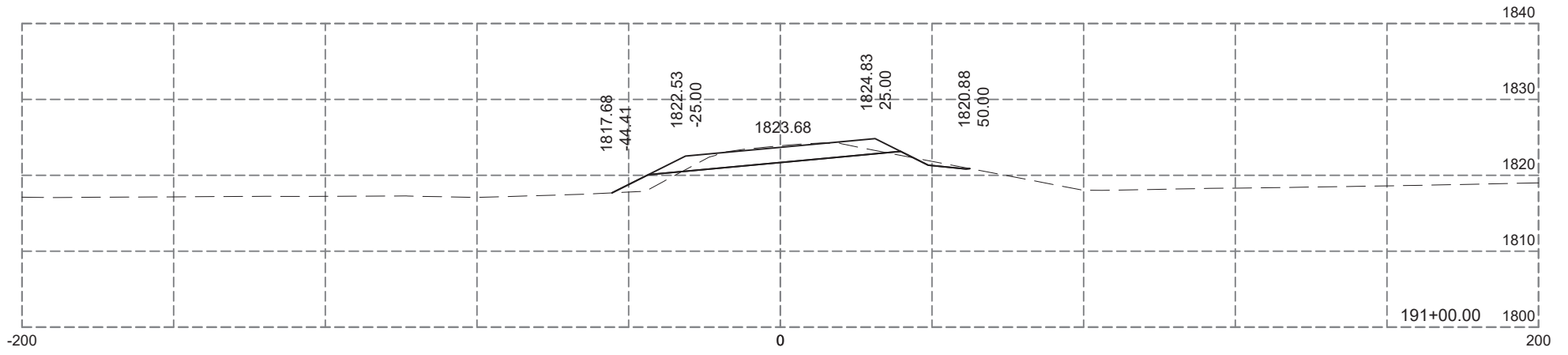
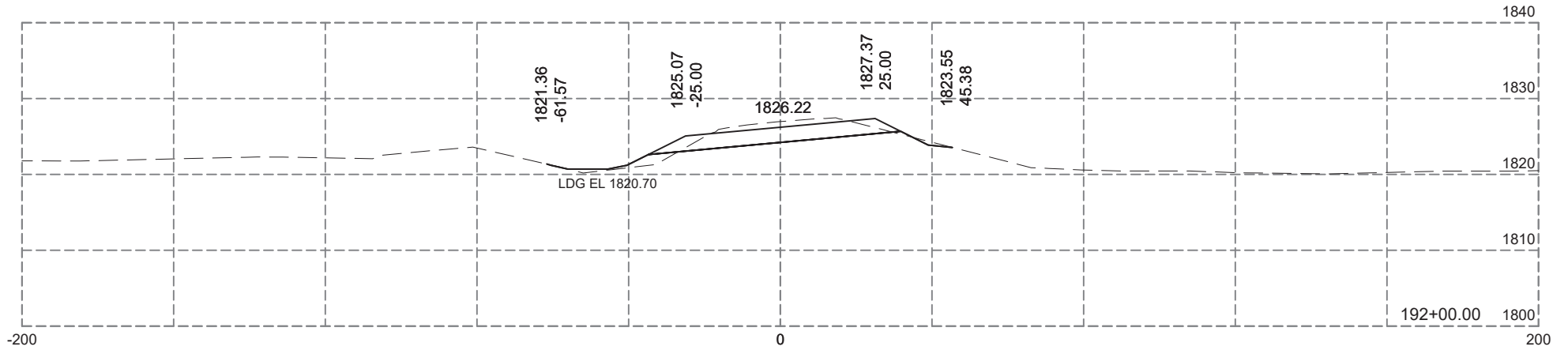

Plotting Date: 12-04-2024

STATE OF SOUTH DAKOTA	PROJECT P-PH-PT 0025(81)158	SHEET X65	TOTAL SHEETS X99
-----------------------	--------------------------------	--------------	---------------------

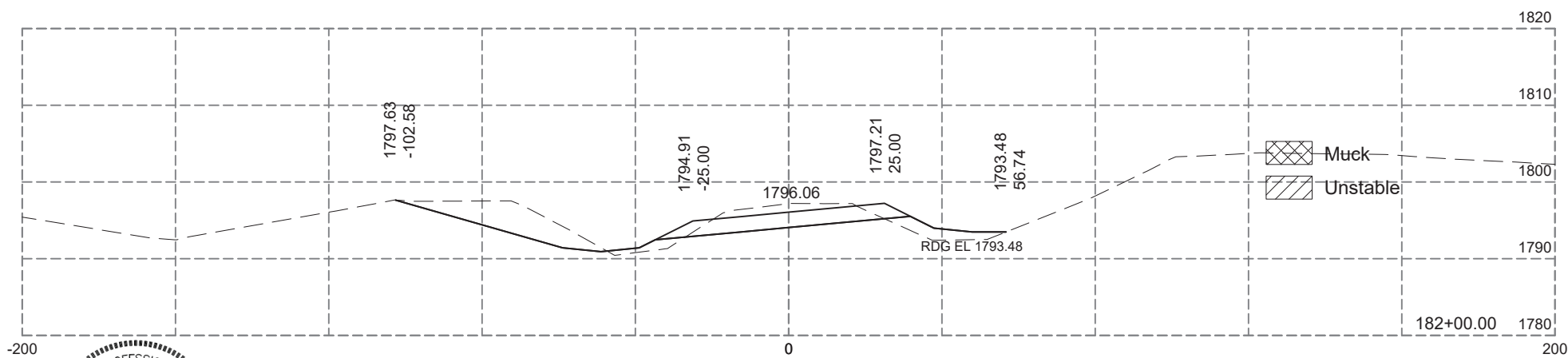
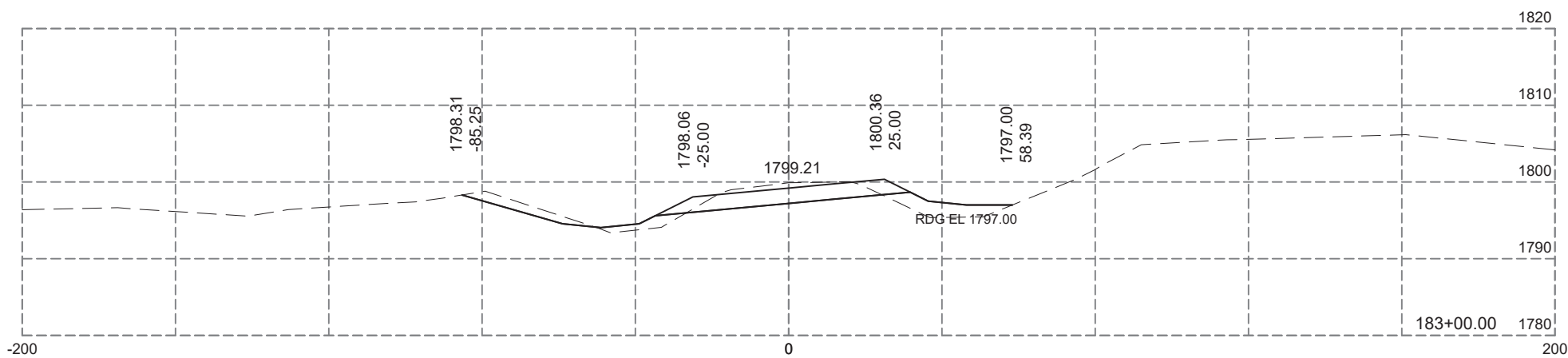
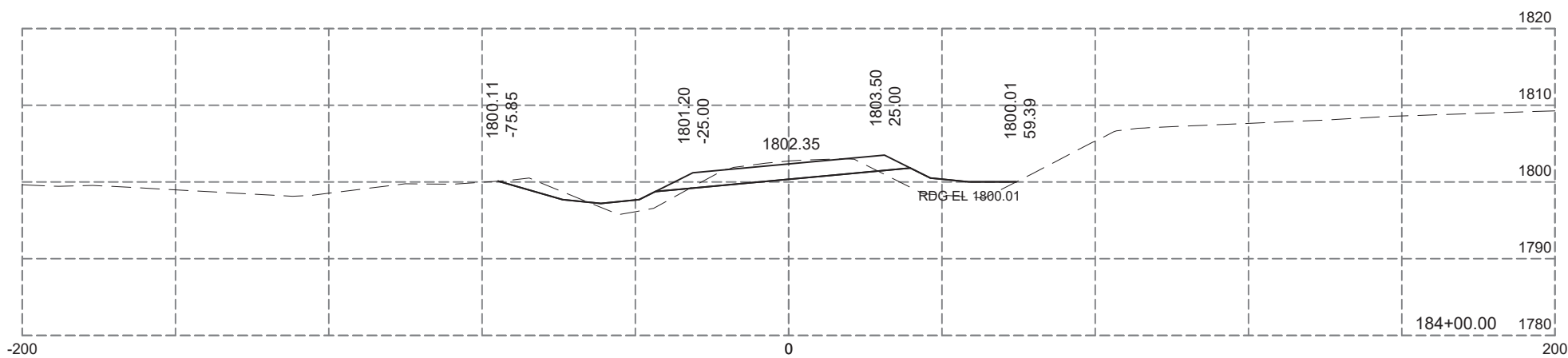
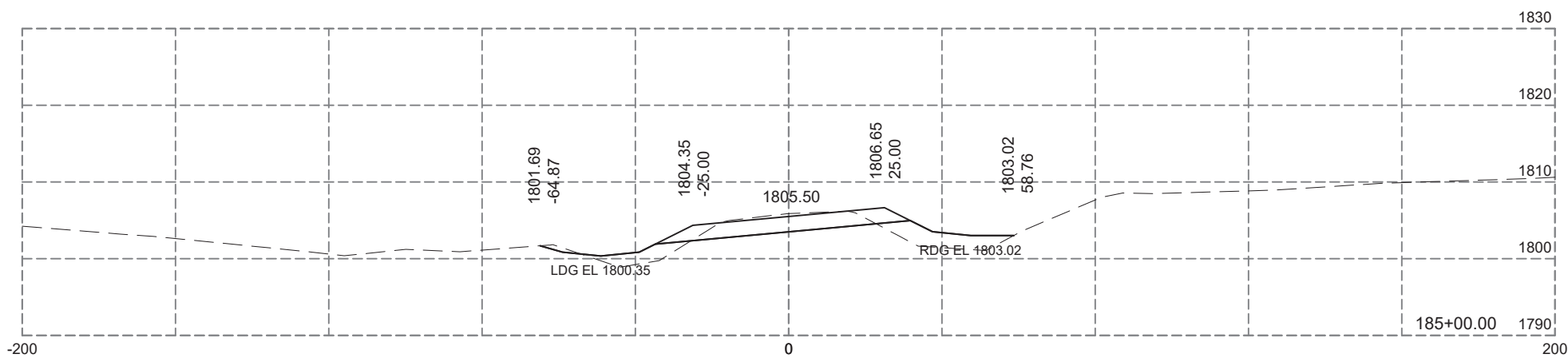
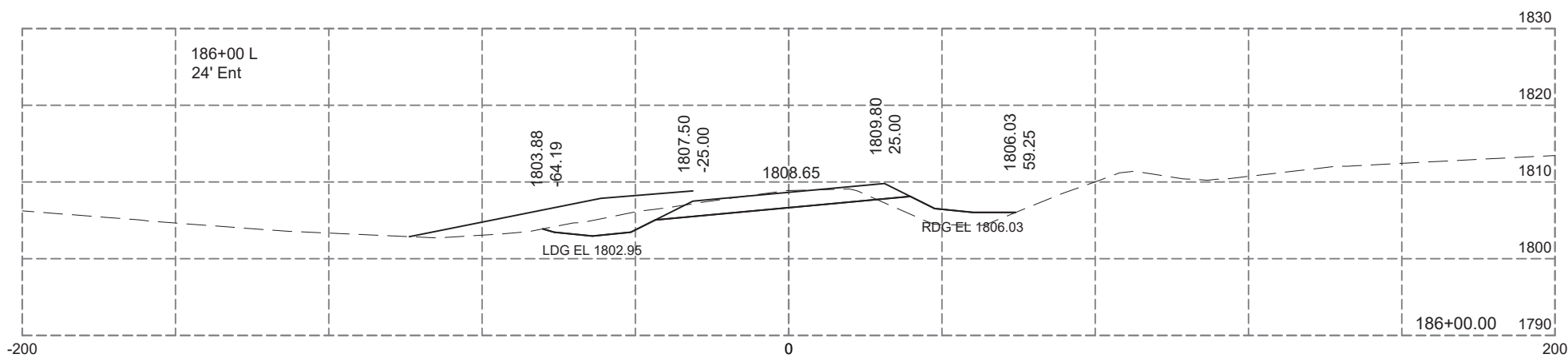
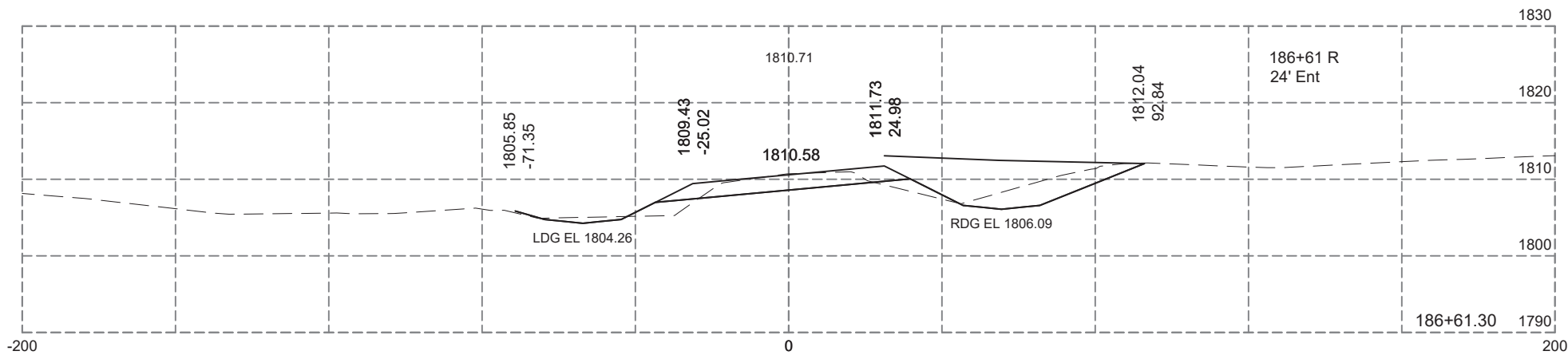

Plotting Date: 12-04-2024

STATE OF SOUTH DAKOTA	PROJECT P-PH-PT 0025(81)158	SHEET X66	TOTAL SHEETS X99
-----------------------	--------------------------------	--------------	---------------------

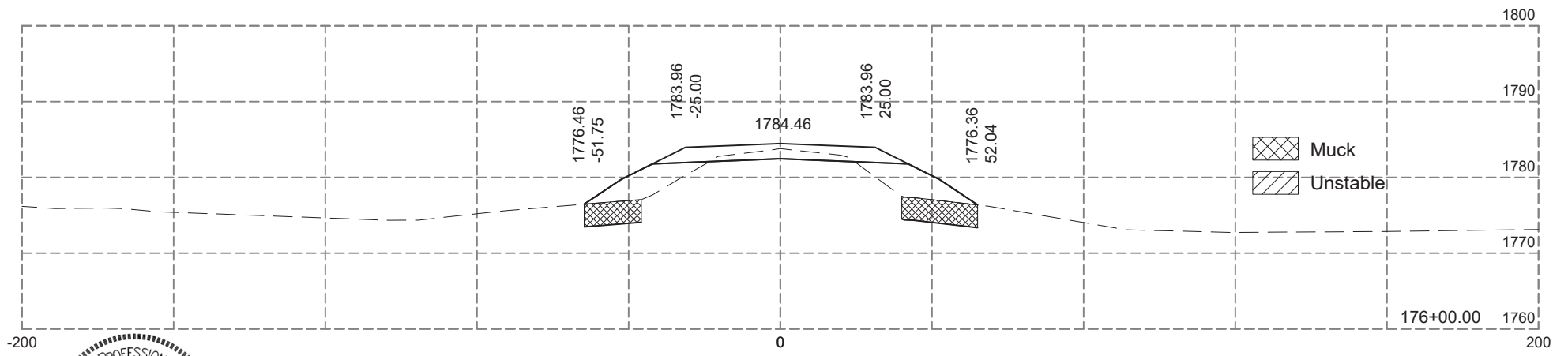
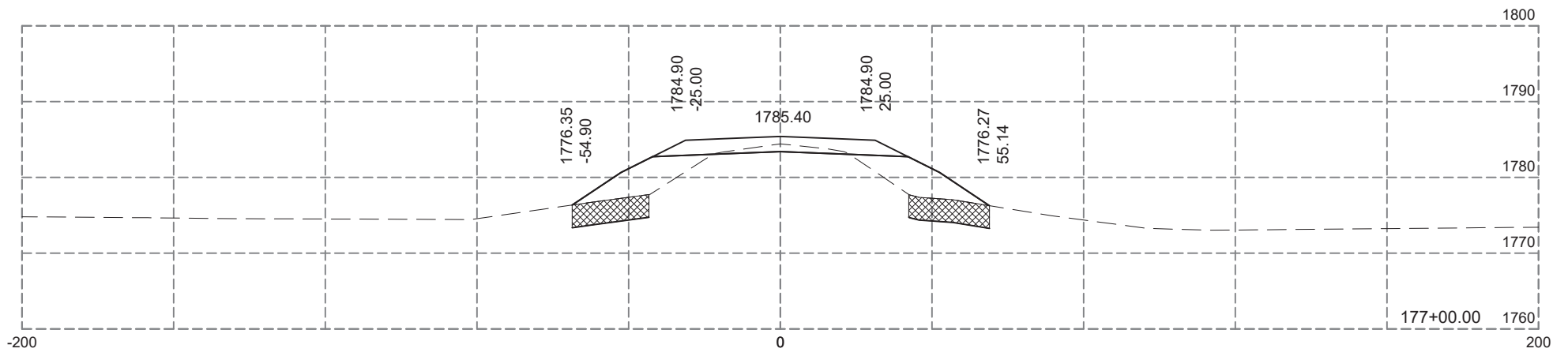
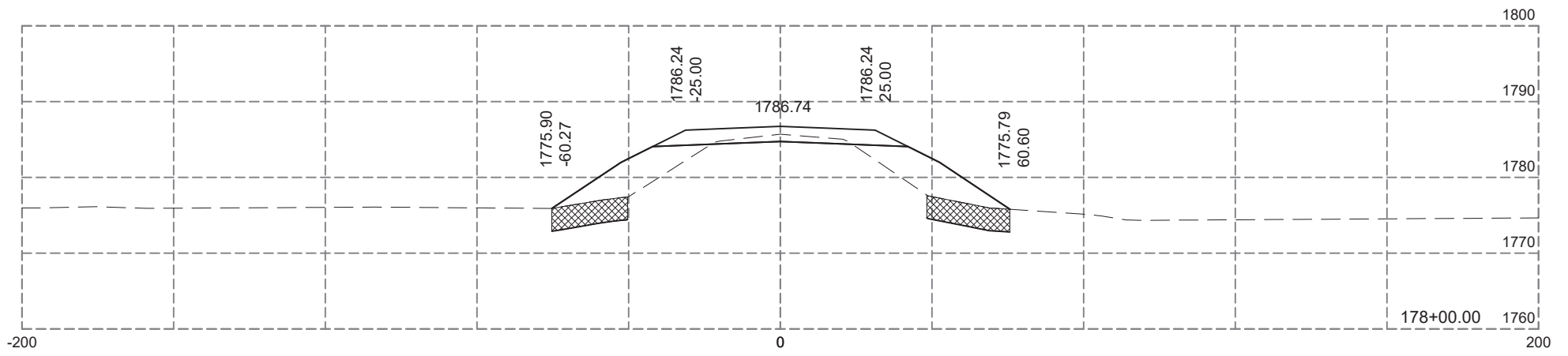
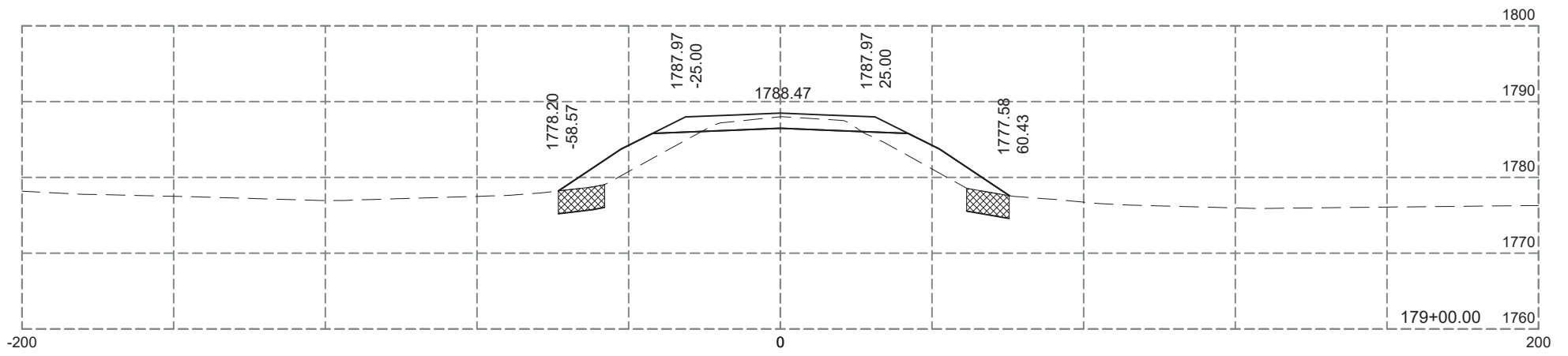
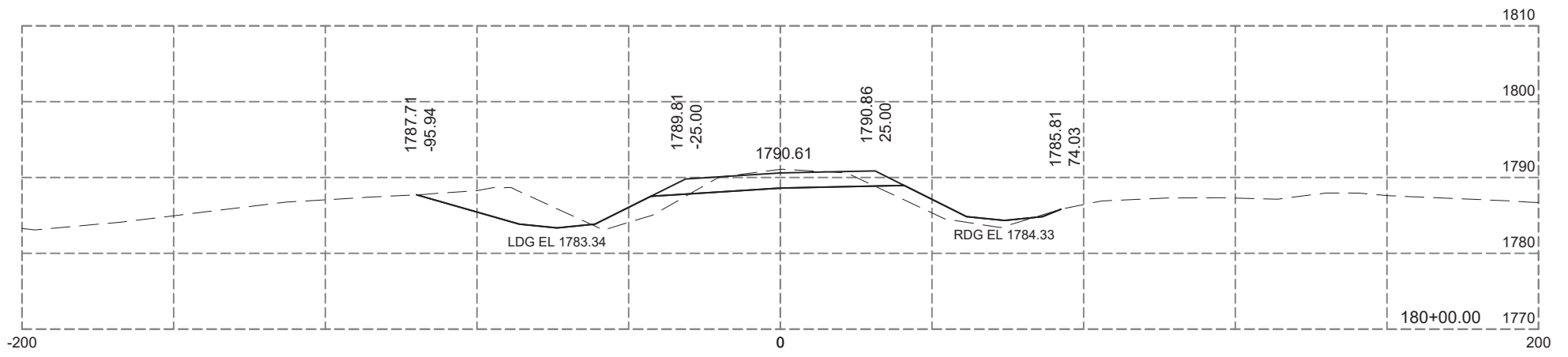
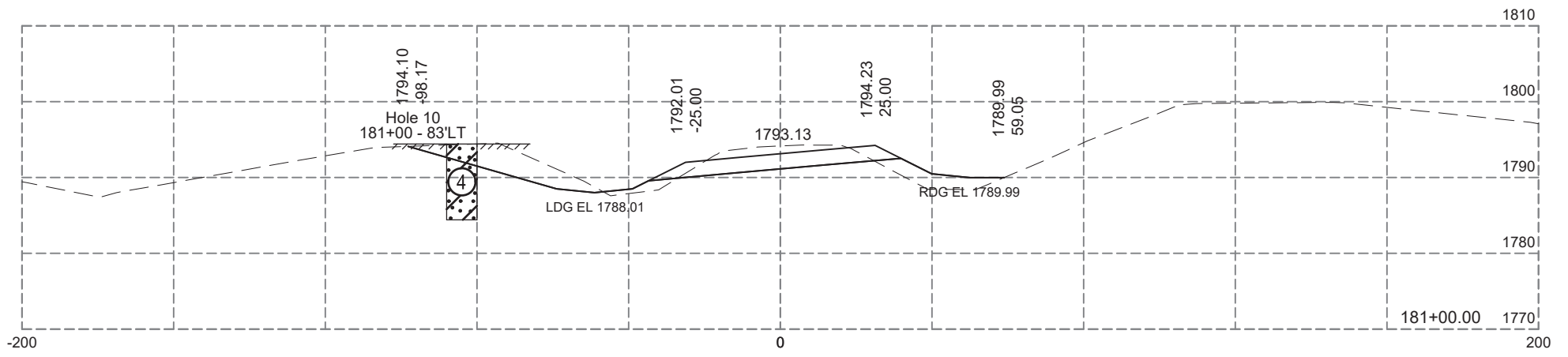

Plotting Date: 12-04-2024

STATE OF SOUTH DAKOTA	PROJECT P-PH-PT 0025(81)158	SHEET X67	TOTAL SHEETS X99
-----------------------	--------------------------------	--------------	---------------------

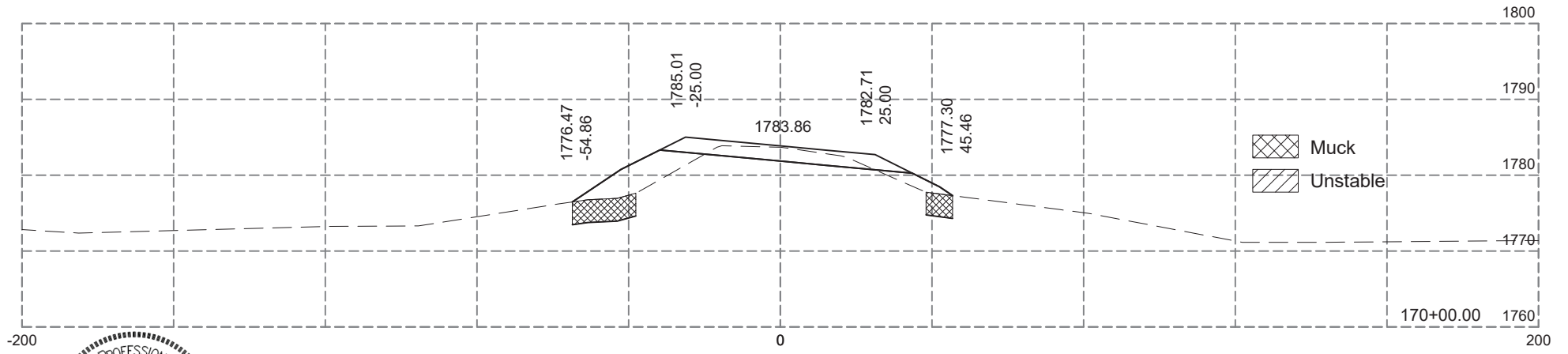
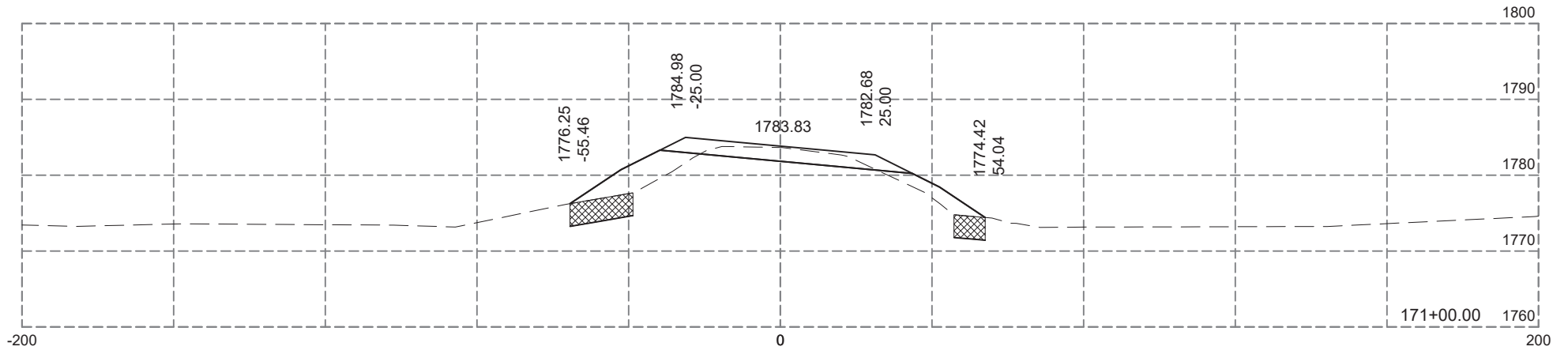
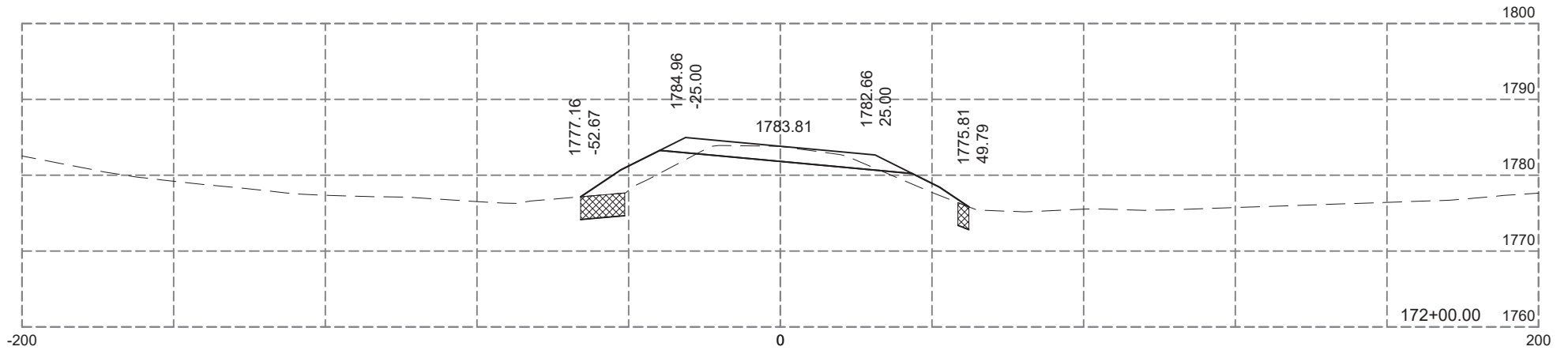
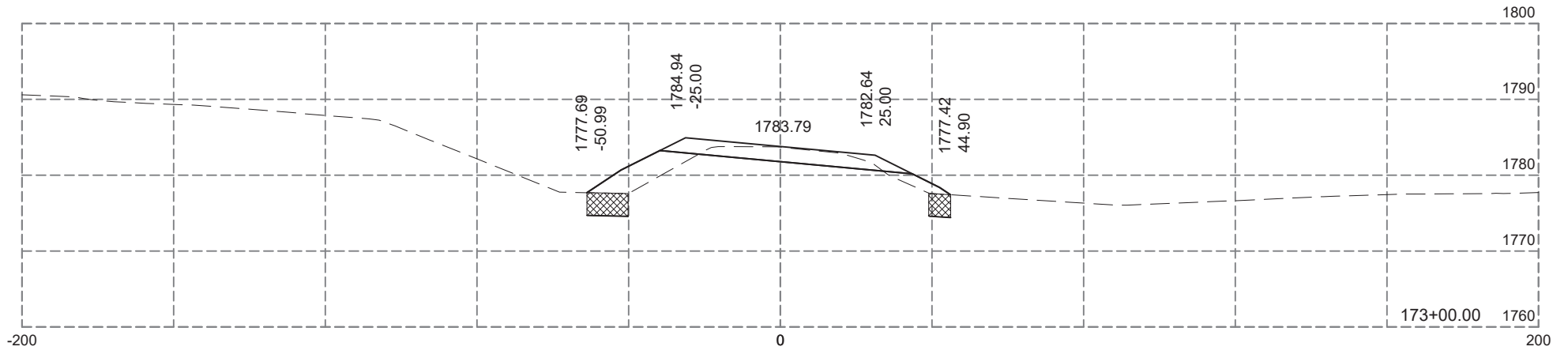
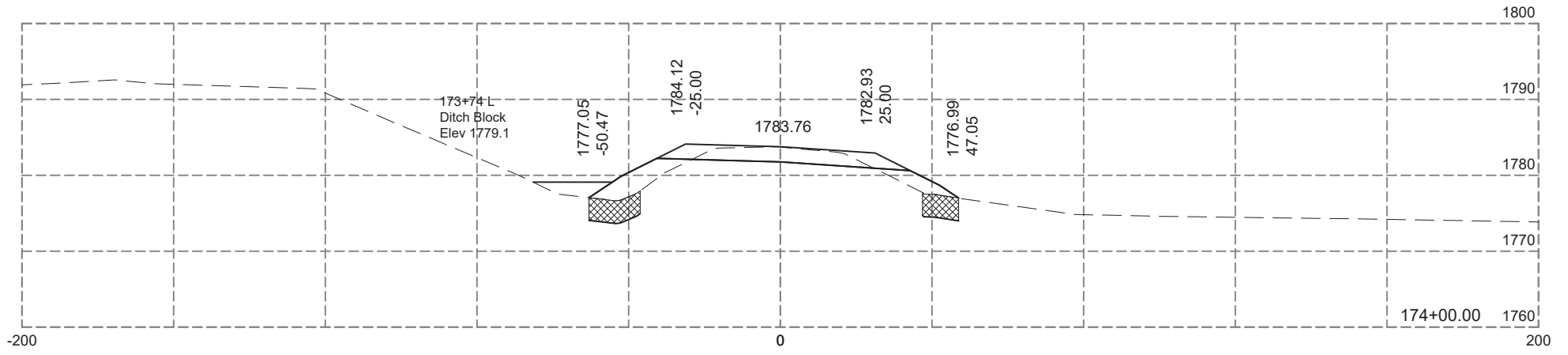
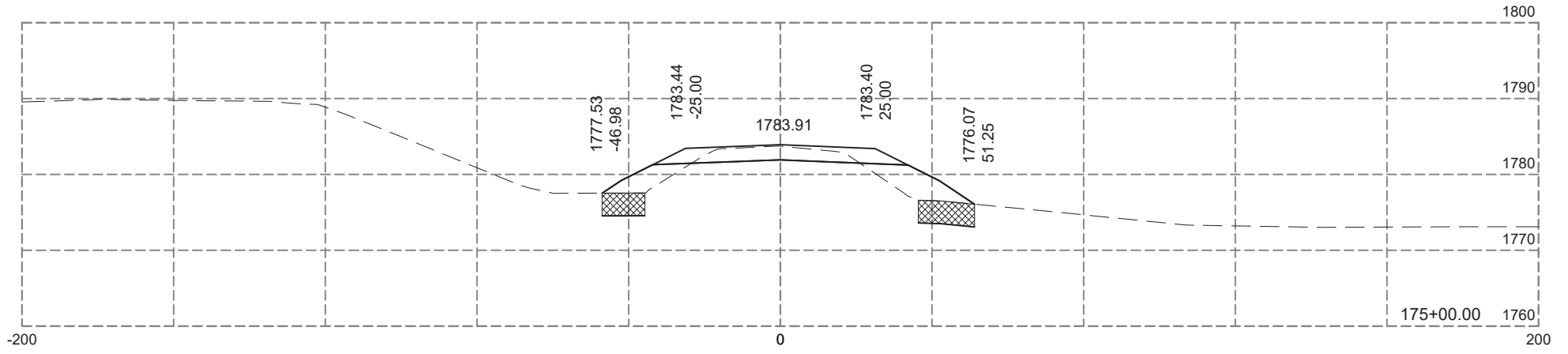

Muck  
 Unstable



Plotting Date: 12-04-2024

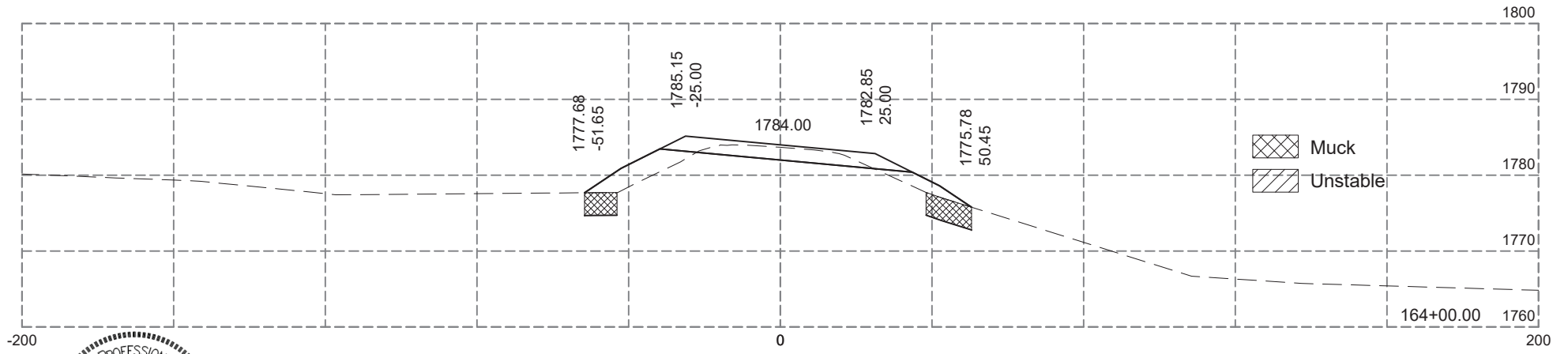
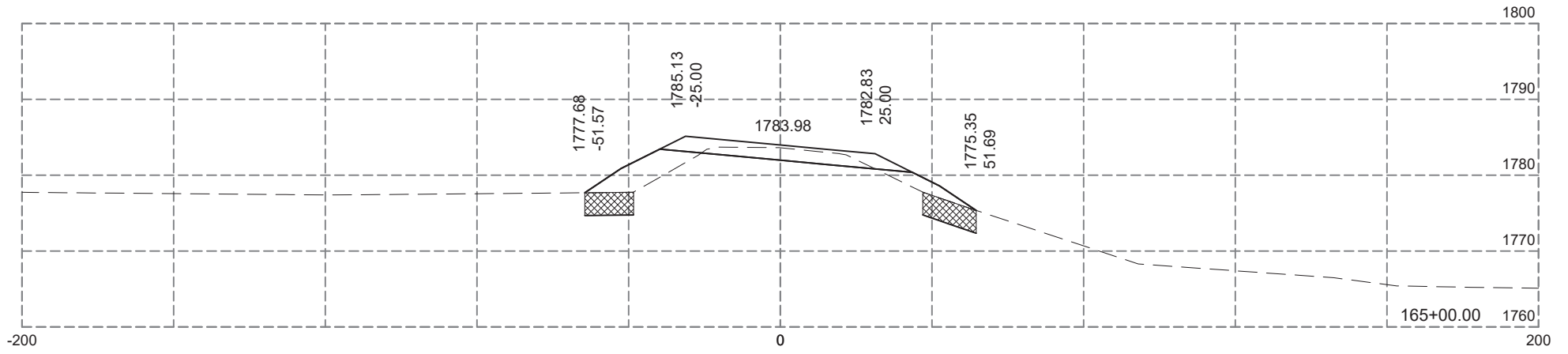
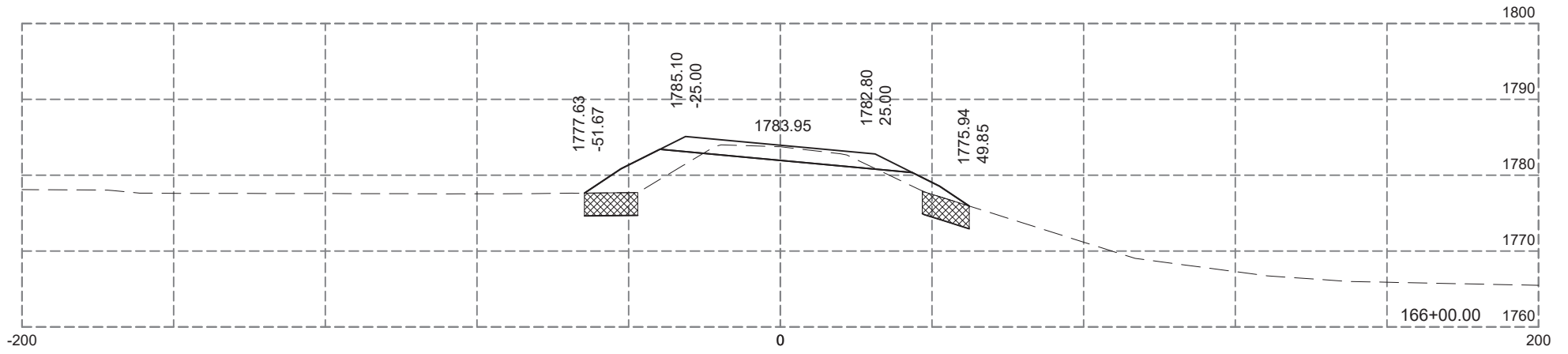
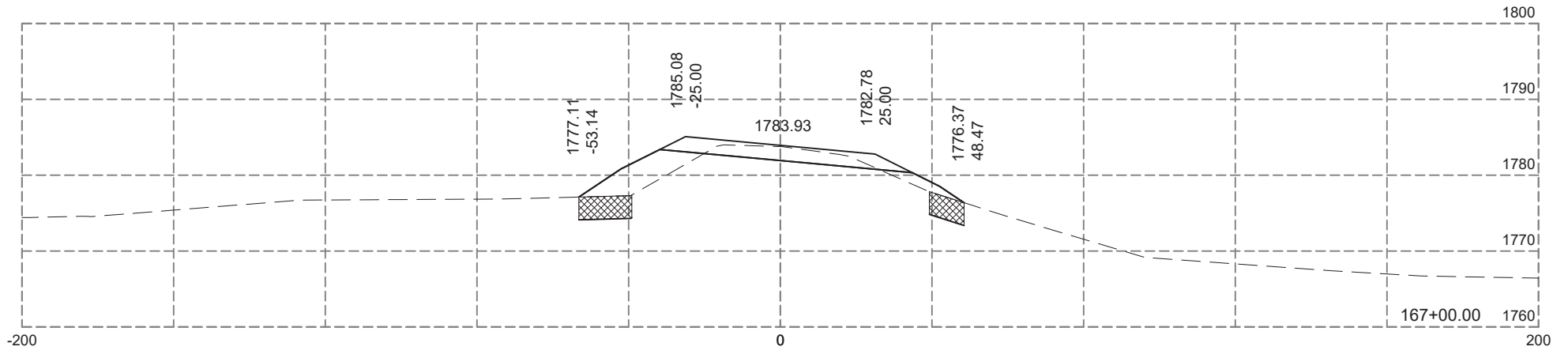
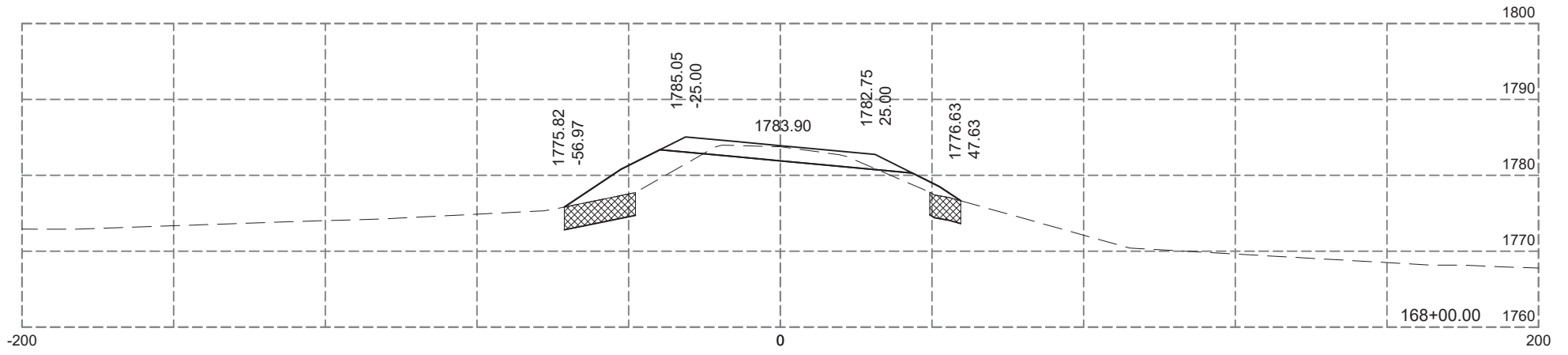
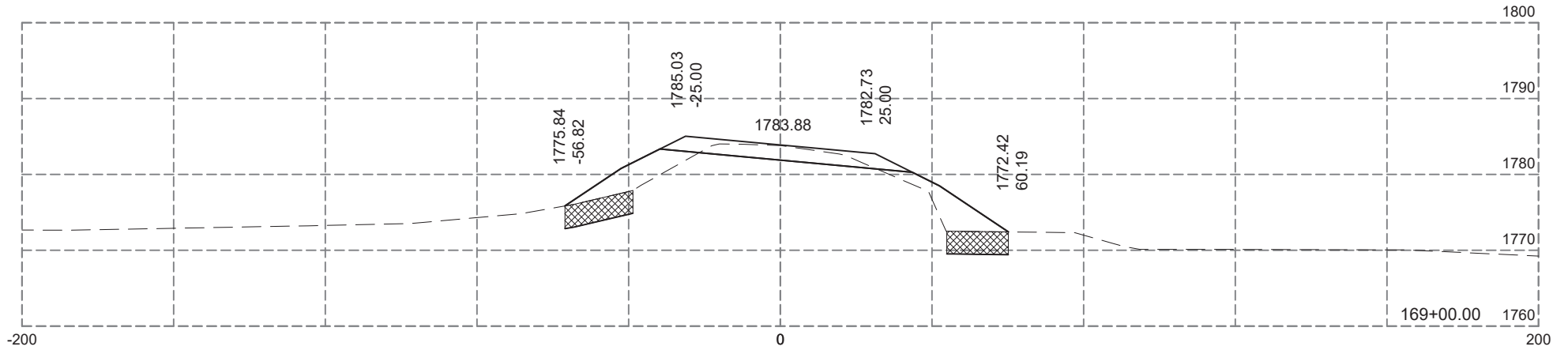

STATE OF SOUTH DAKOTA	PROJECT	SHEET	TOTAL SHEETS
	P-PH-PT 0025(81)158	X68	X99

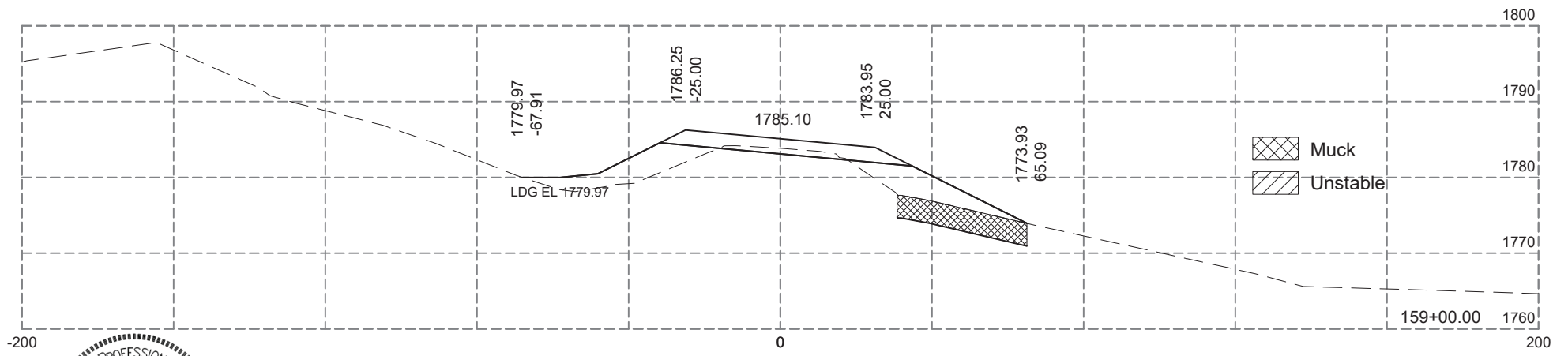
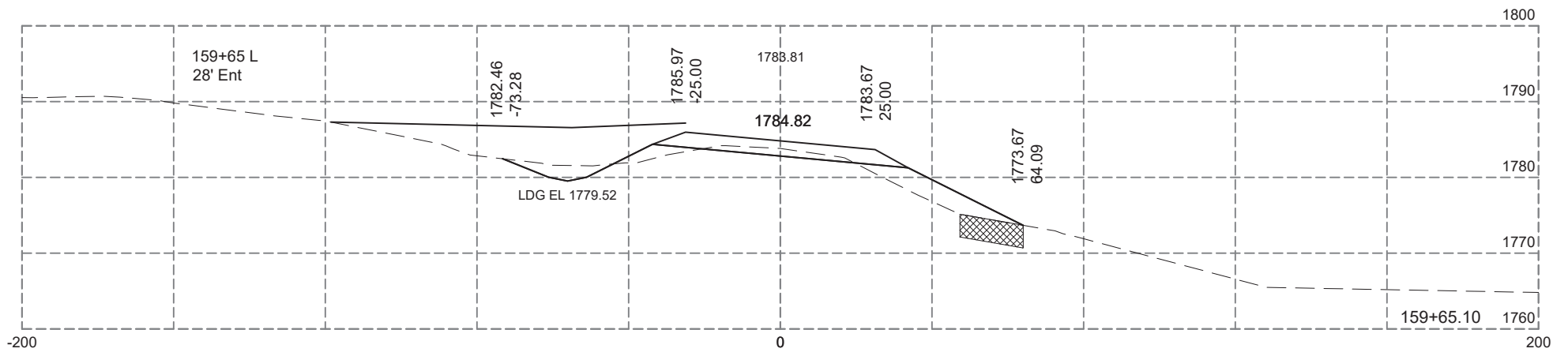
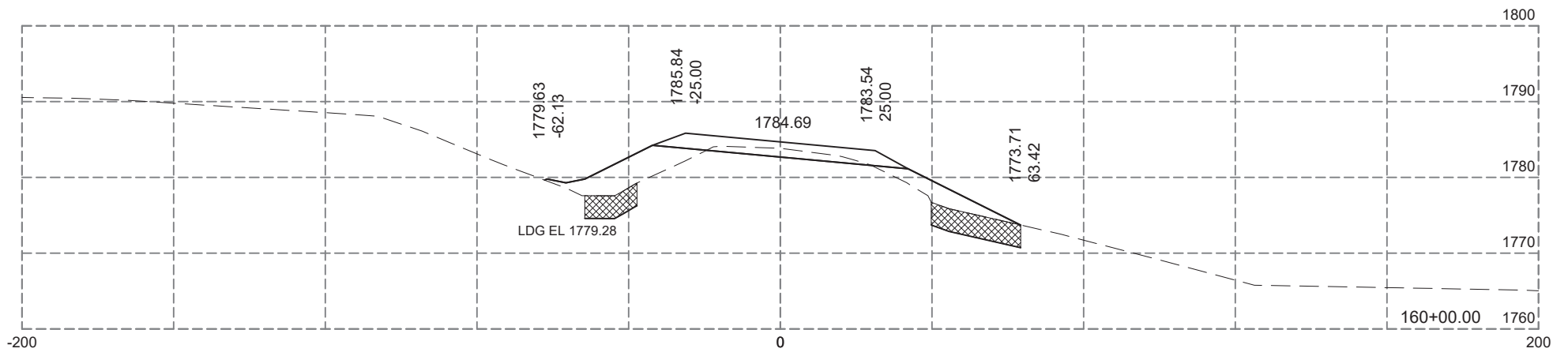
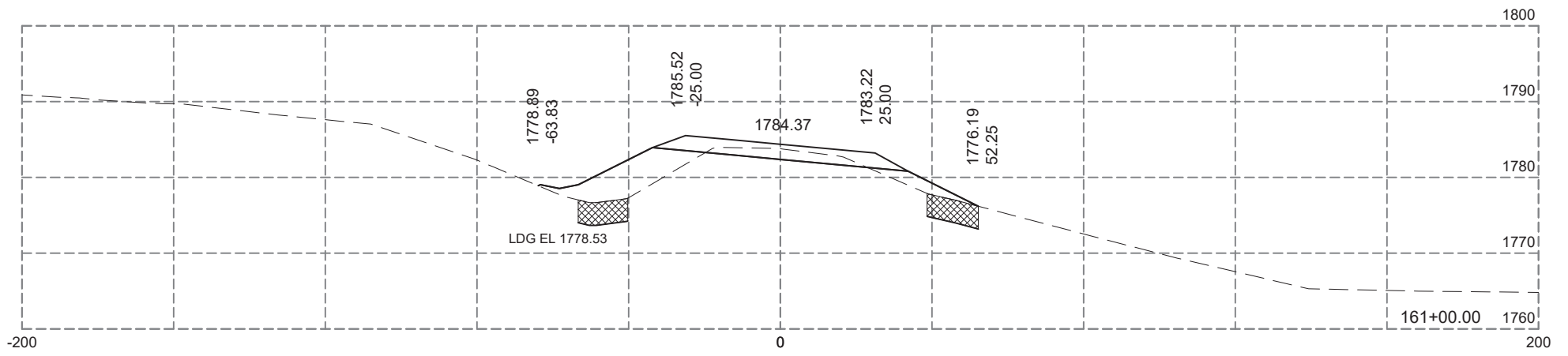
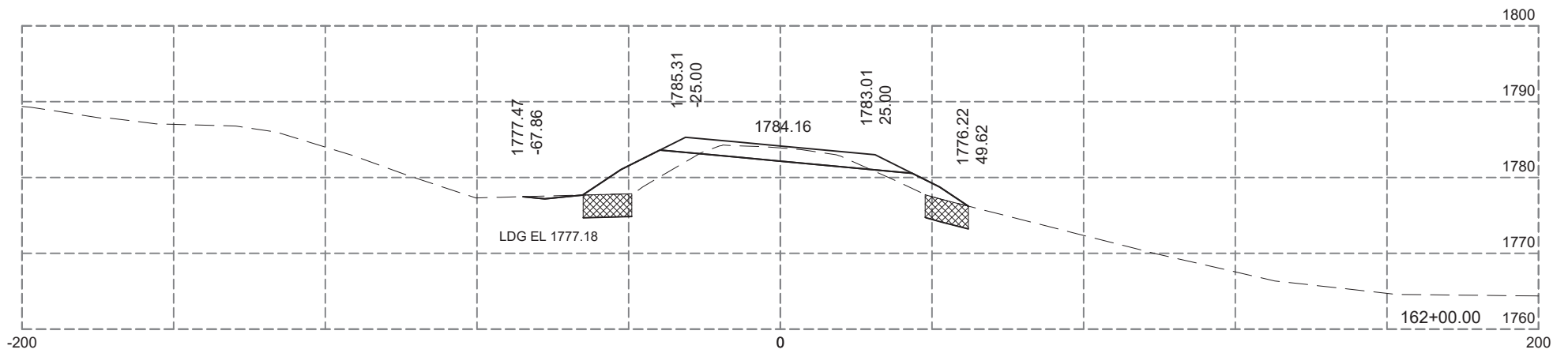
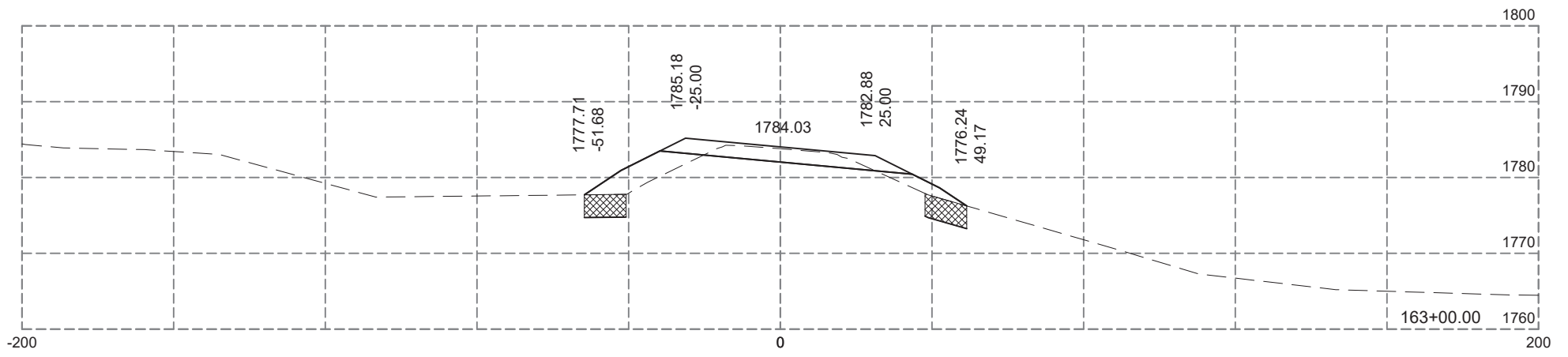

Plotting Date: 12-04-2024

STATE OF SOUTH DAKOTA	PROJECT	SHEET	TOTAL SHEETS
	P-PH-PT 0025(81)158	X69	X99



 Muck  
 Unstable



Plotting Date: 12-04-2024

STATE OF SOUTH DAKOTA	PROJECT P-PH-PT 0025(81)158	SHEET X70	TOTAL SHEETS X99
-----------------------	--------------------------------	--------------	---------------------

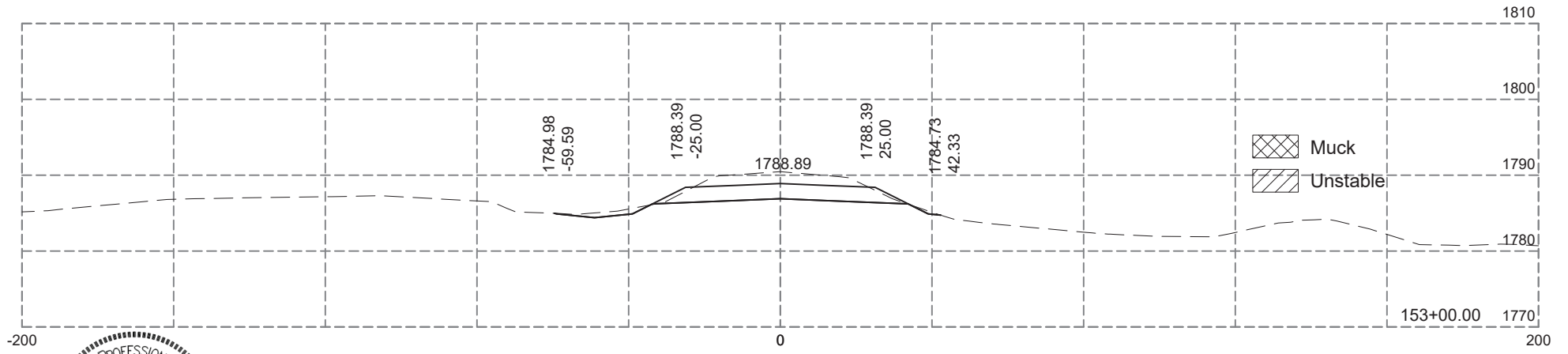
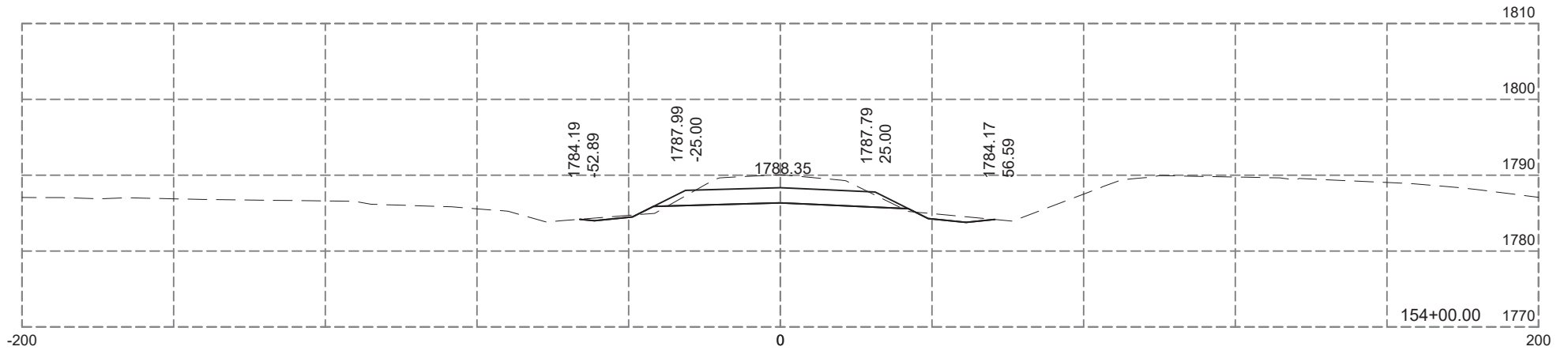
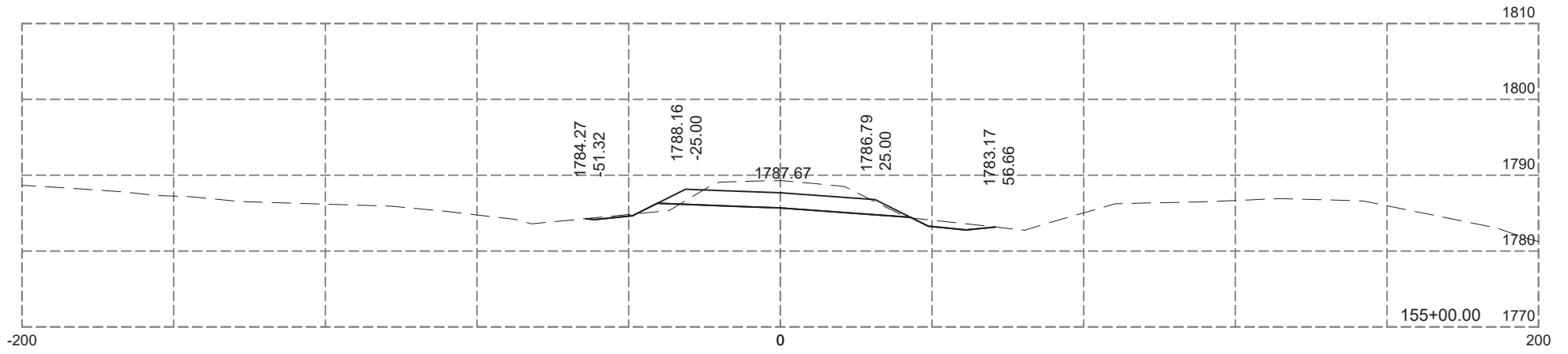
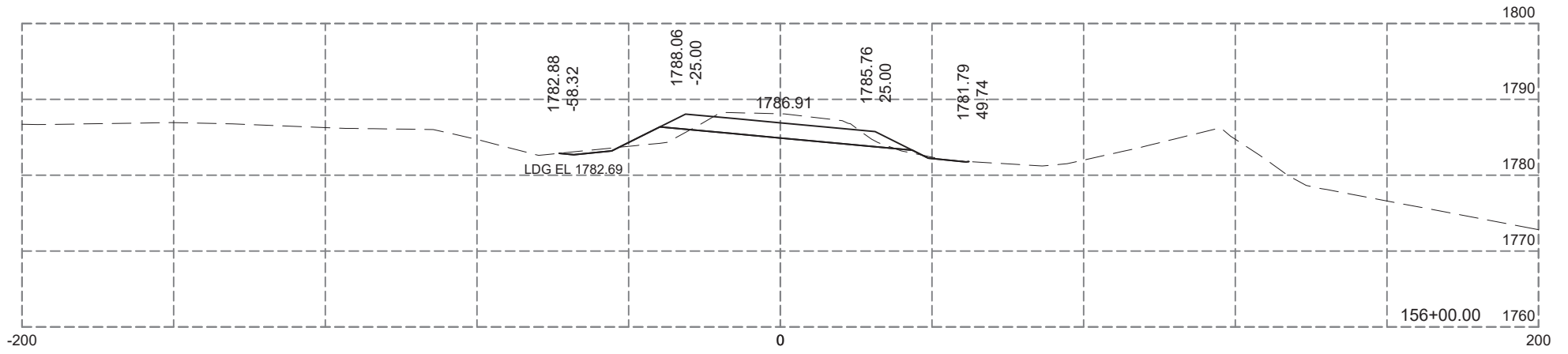
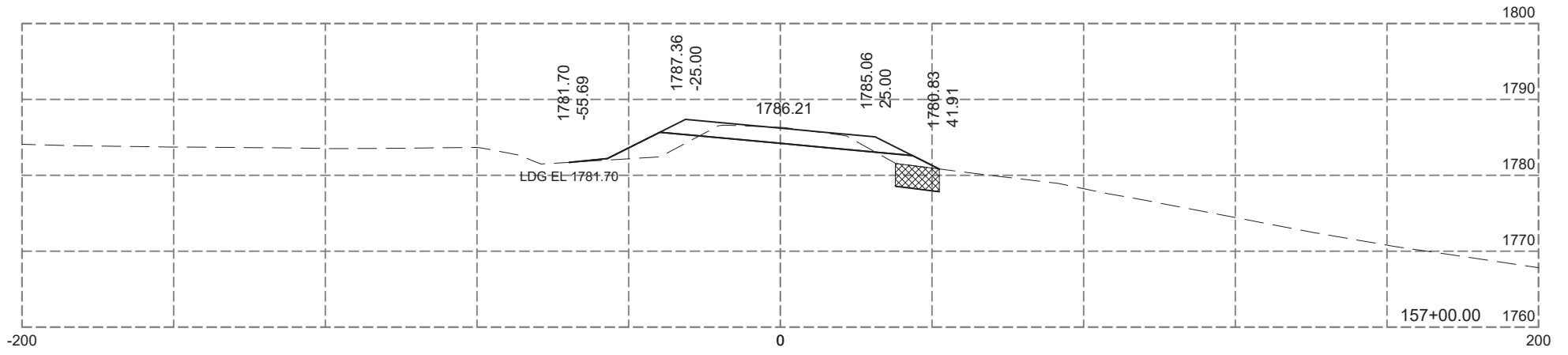
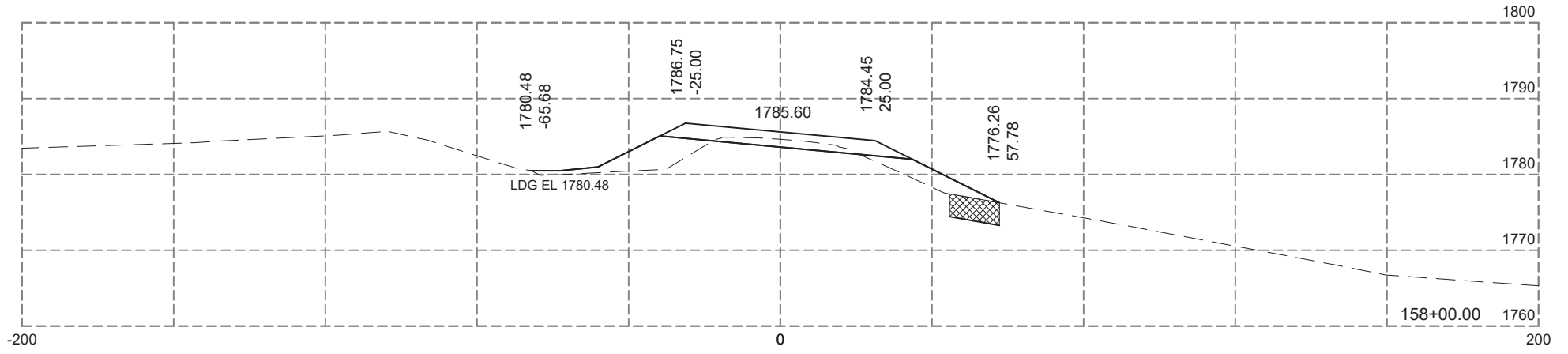

Plotting Date: 12-04-2024

STATE OF SOUTH DAKOTA	PROJECT P-PH-PT 0025(81)158	SHEET X71	TOTAL SHEETS X99
-----------------------	--------------------------------	--------------	---------------------

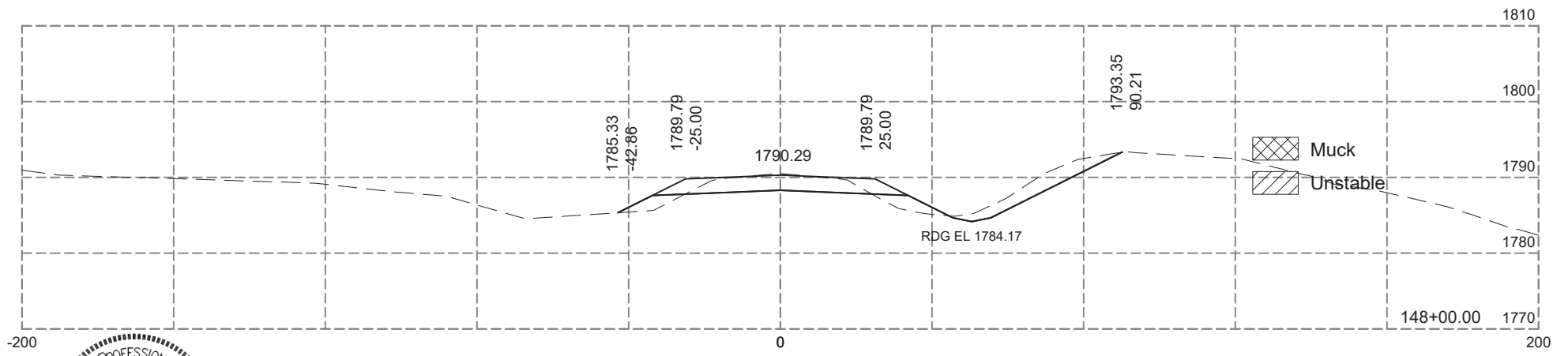
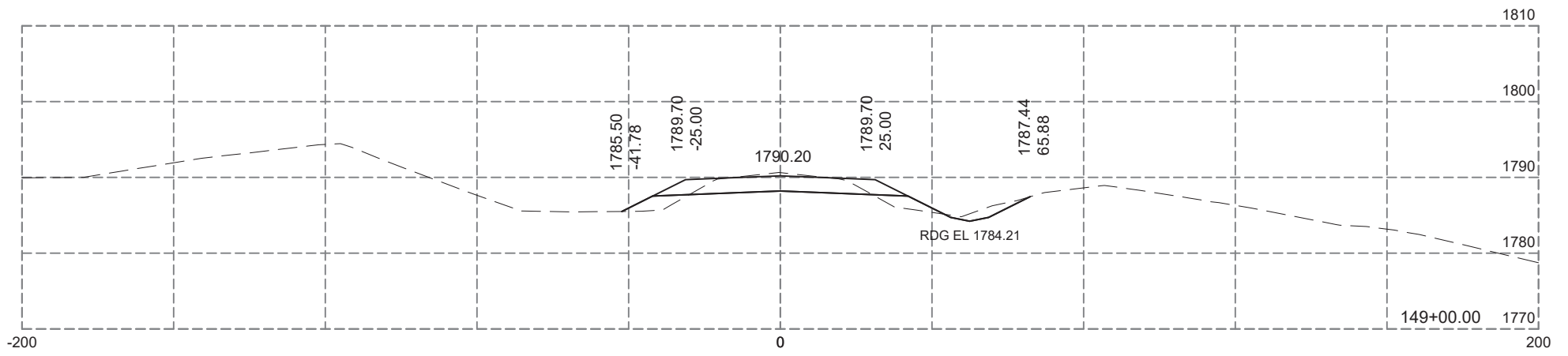
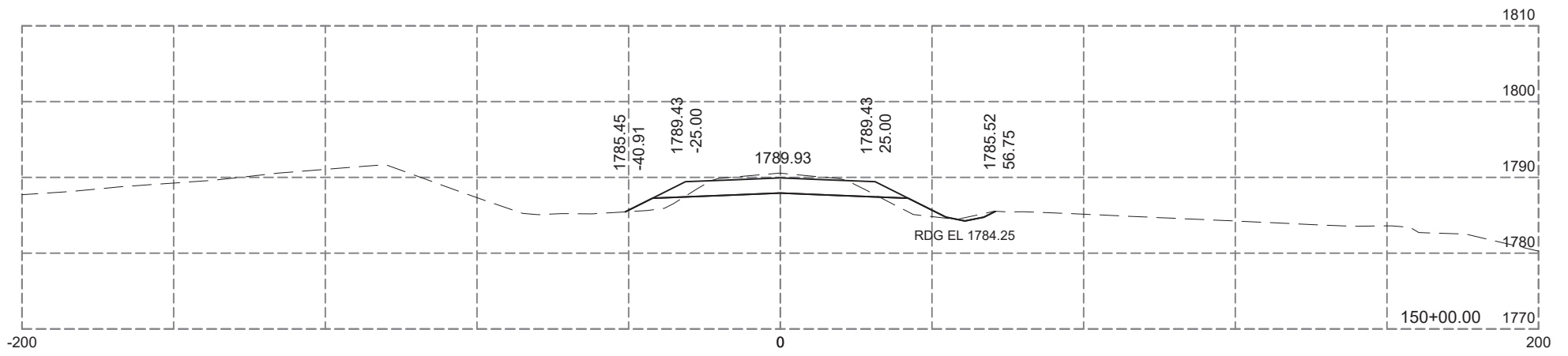
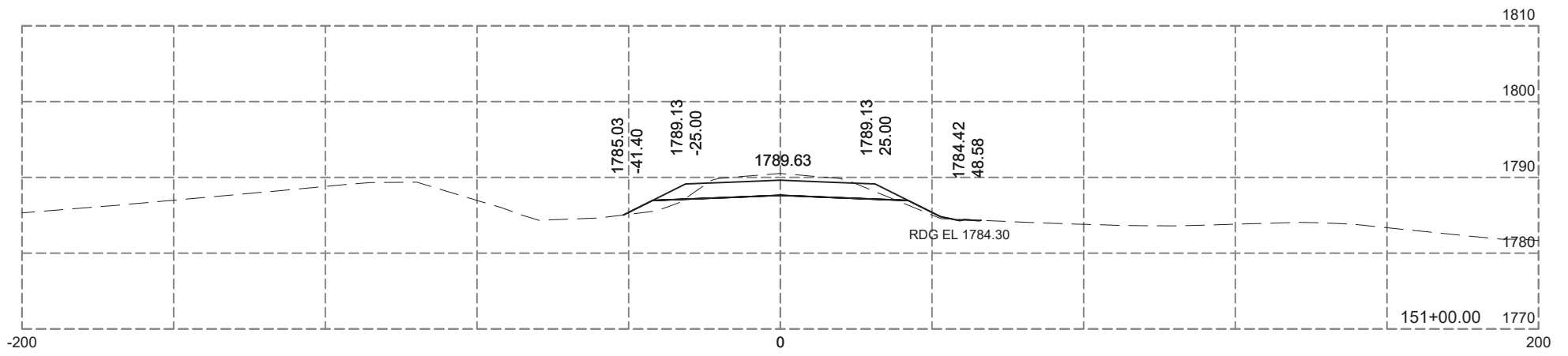
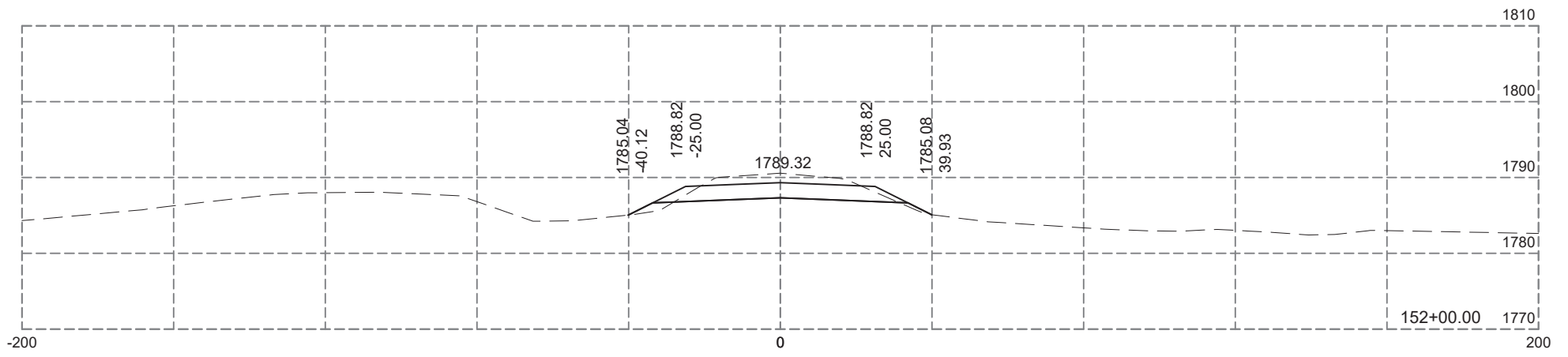
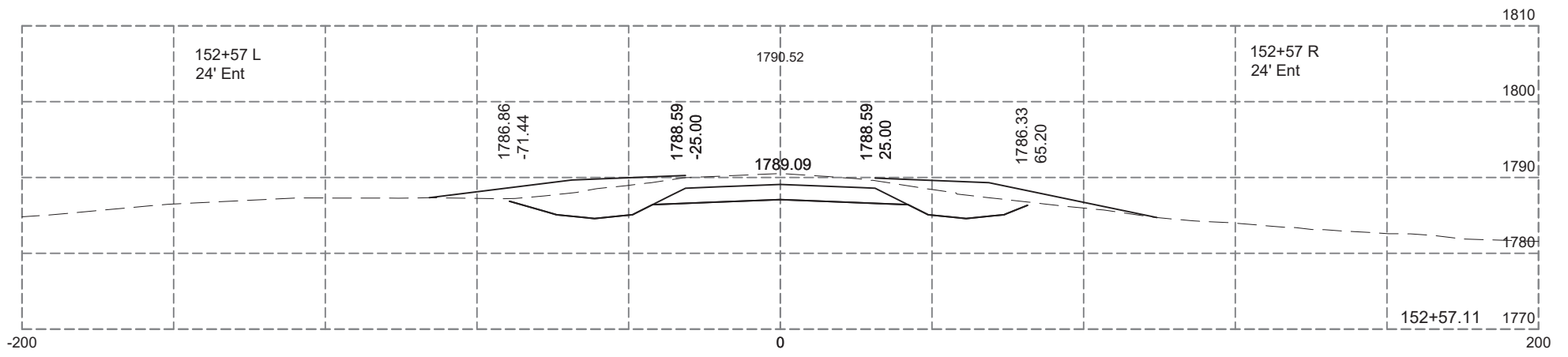

Plotting Date: 12-04-2024

STATE OF SOUTH DAKOTA	PROJECT P-PH-PT 0025(81)158	SHEET X72	TOTAL SHEETS X99
-----------------------	--------------------------------	--------------	---------------------



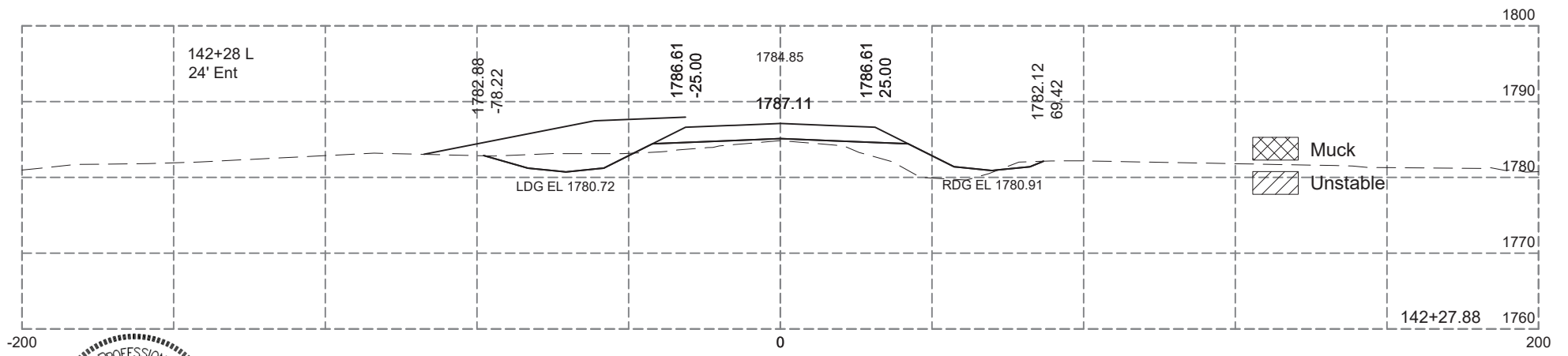
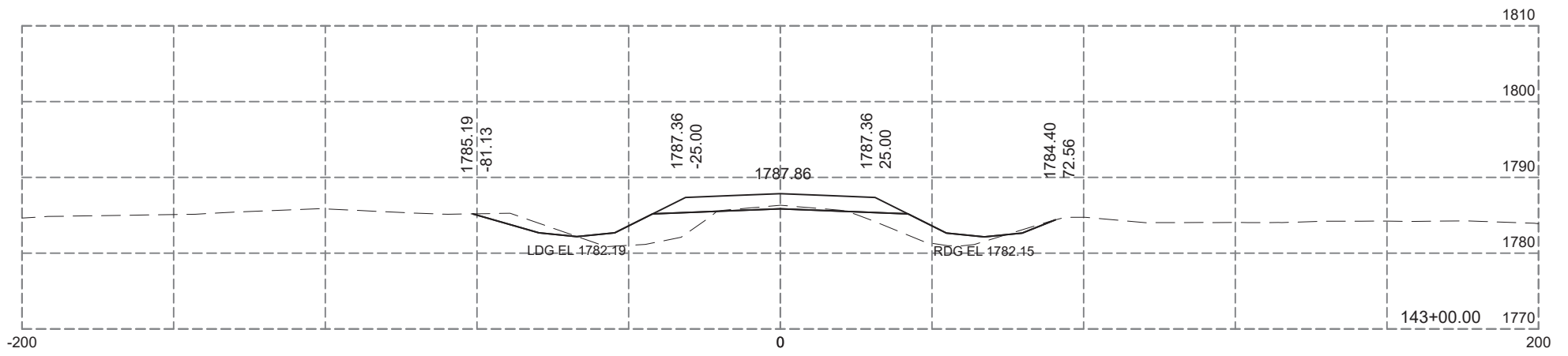
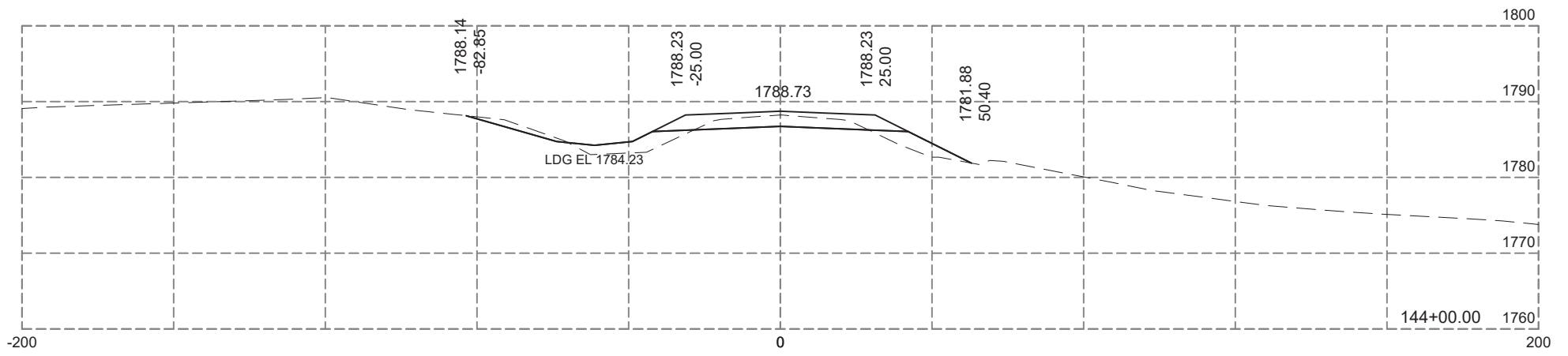
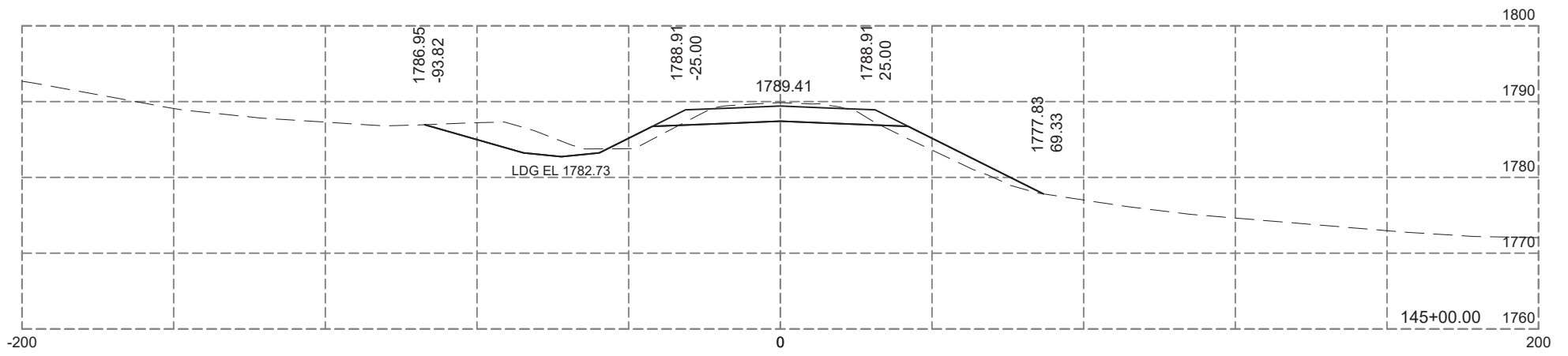
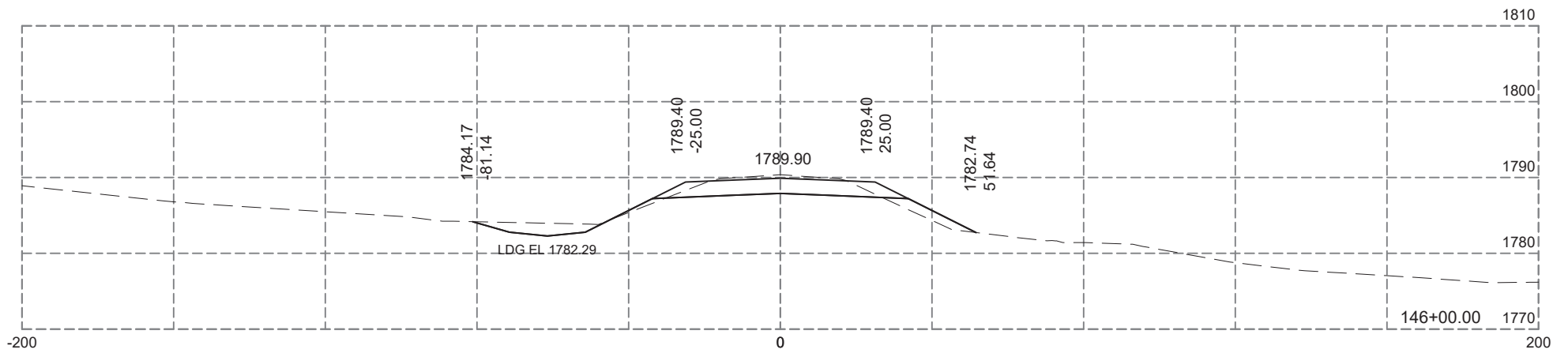
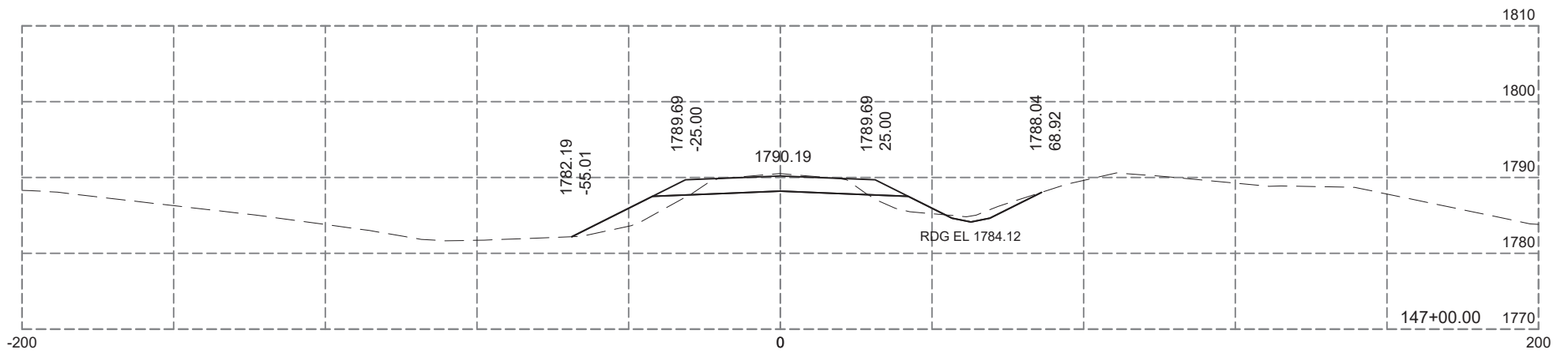

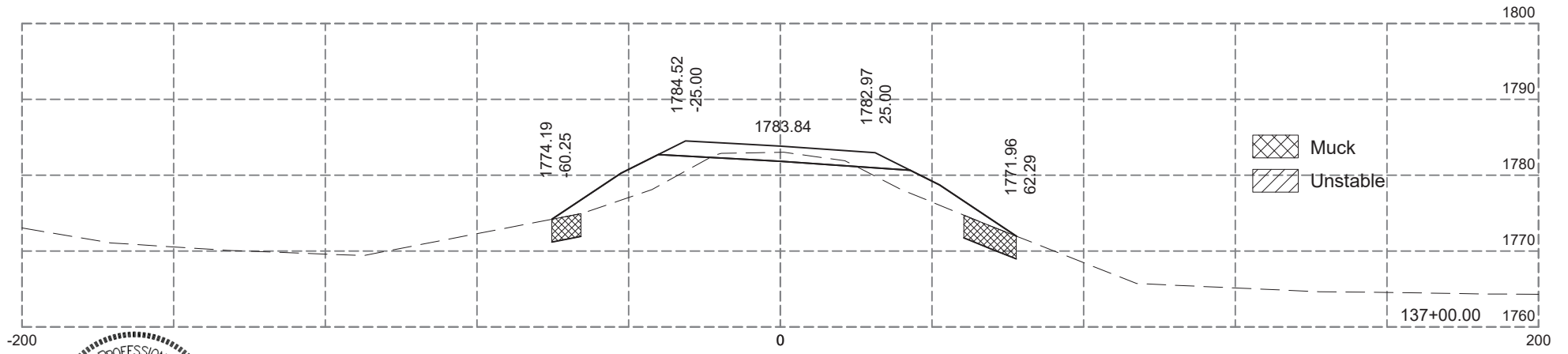
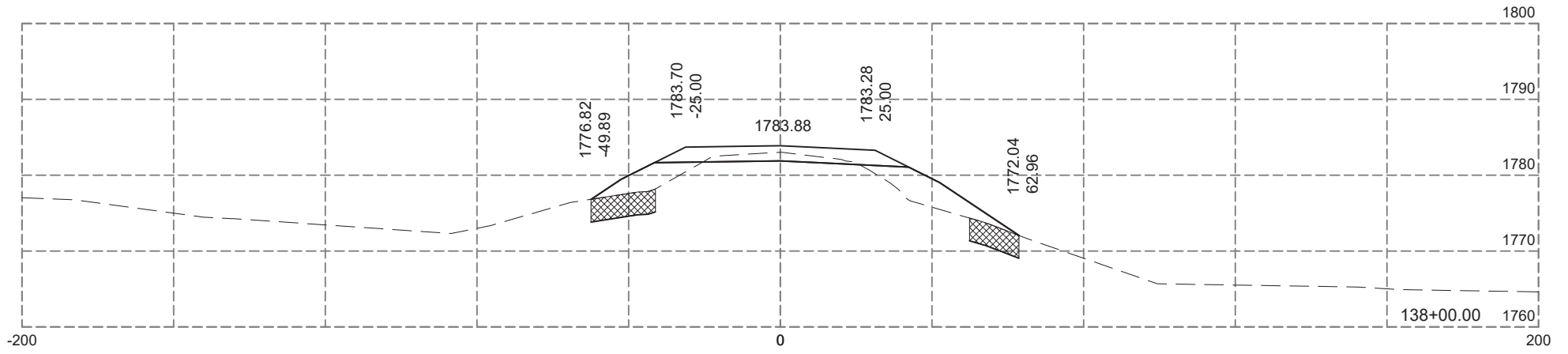
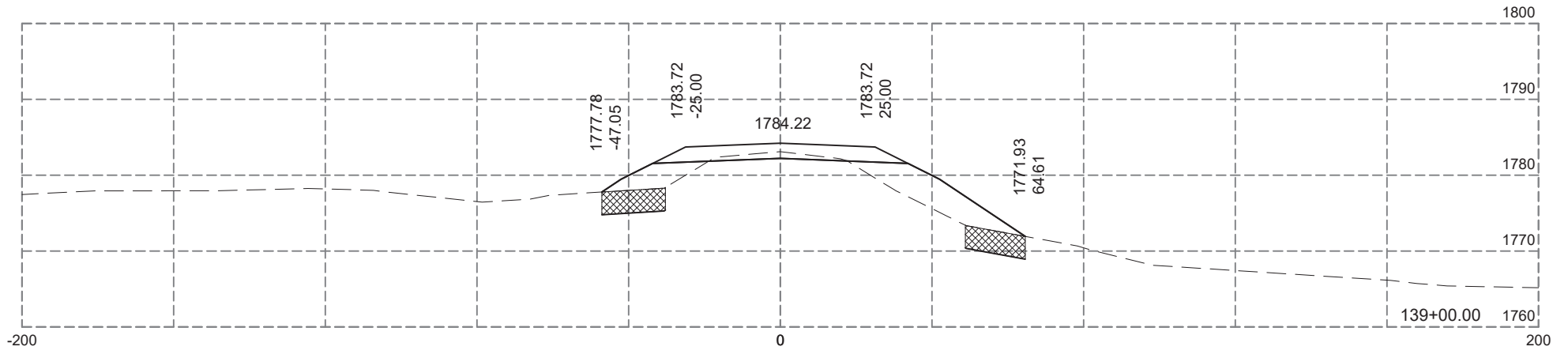
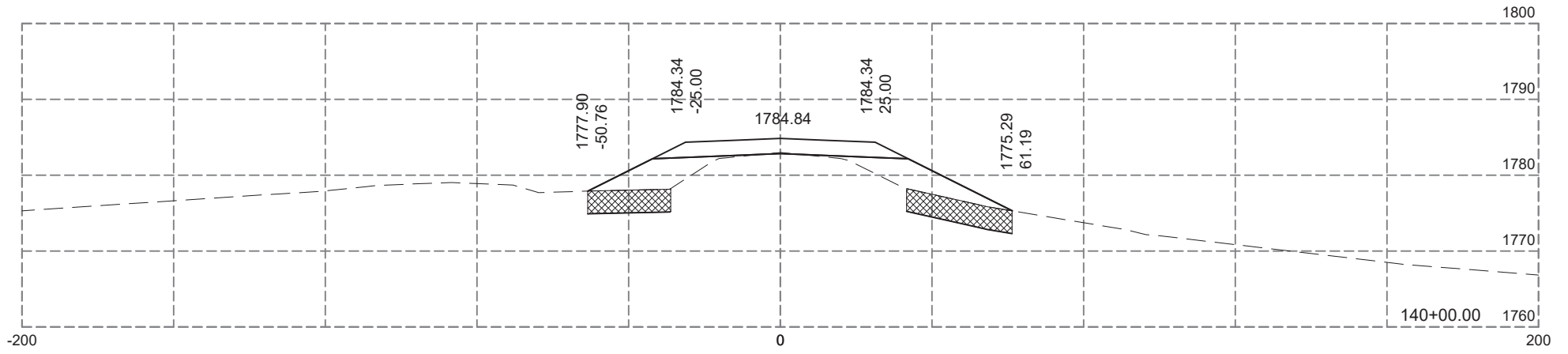
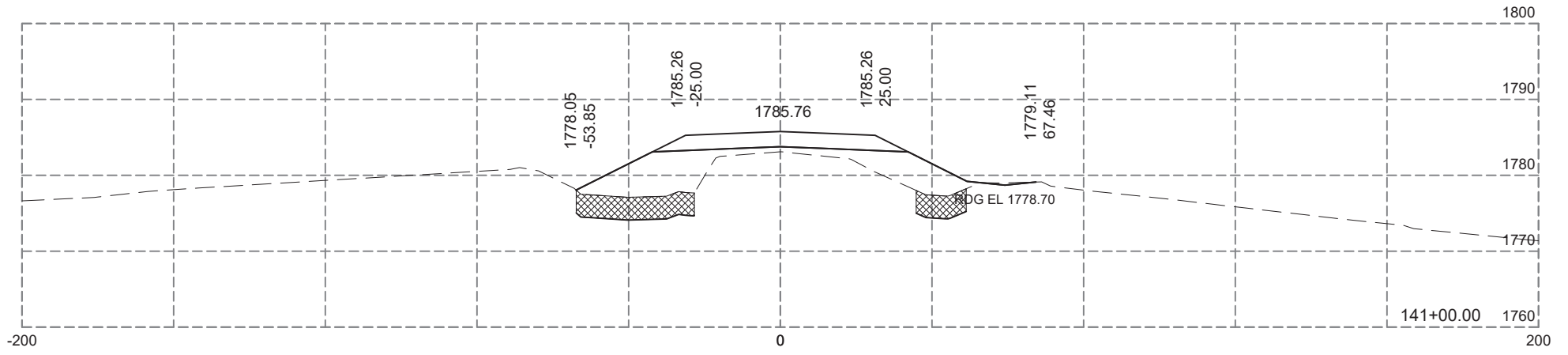
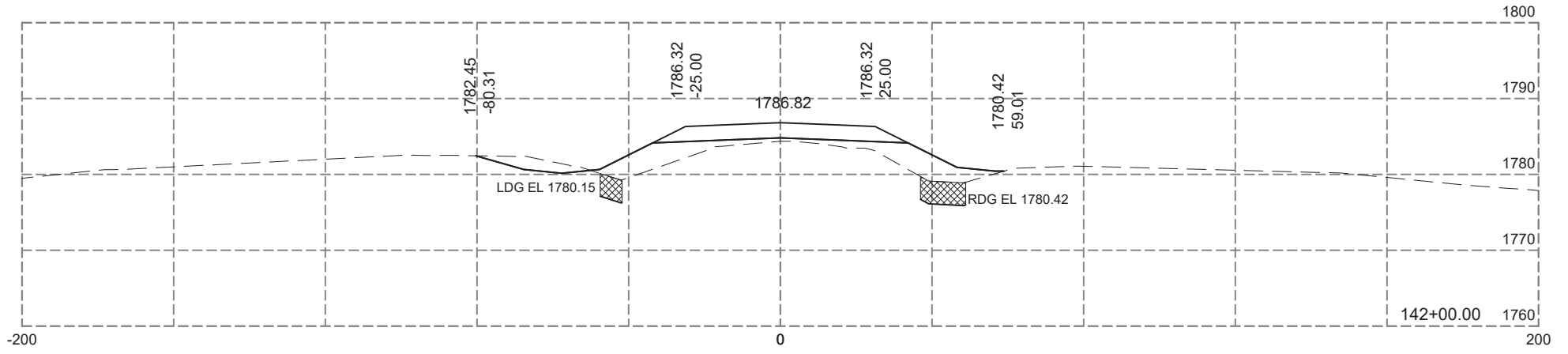

Plotting Date: 12-04-2024

STATE OF SOUTH DAKOTA	PROJECT P-PH-PT 0025(81)158	SHEET X73	TOTAL SHEETS X99
-----------------------	--------------------------------	--------------	---------------------





 Muck  
 Unstable

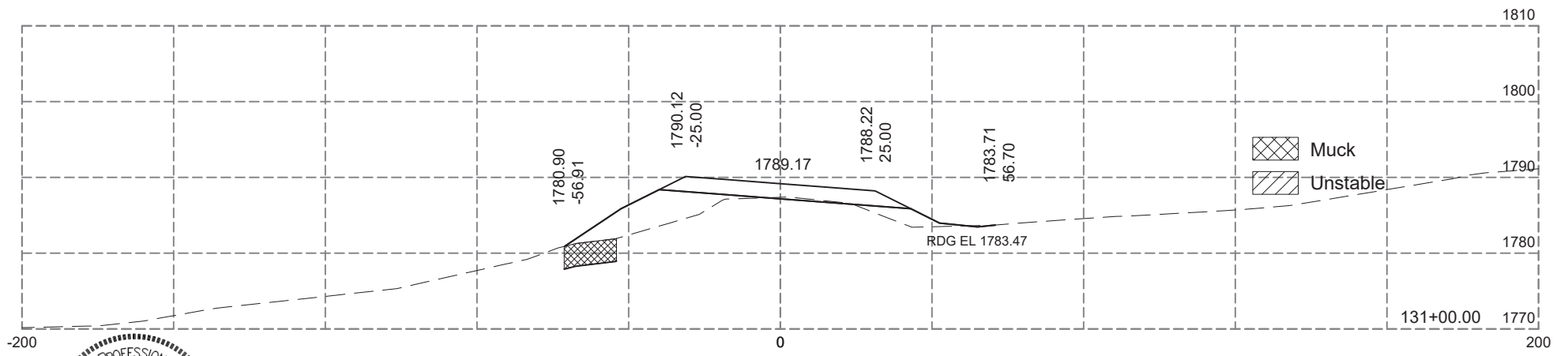
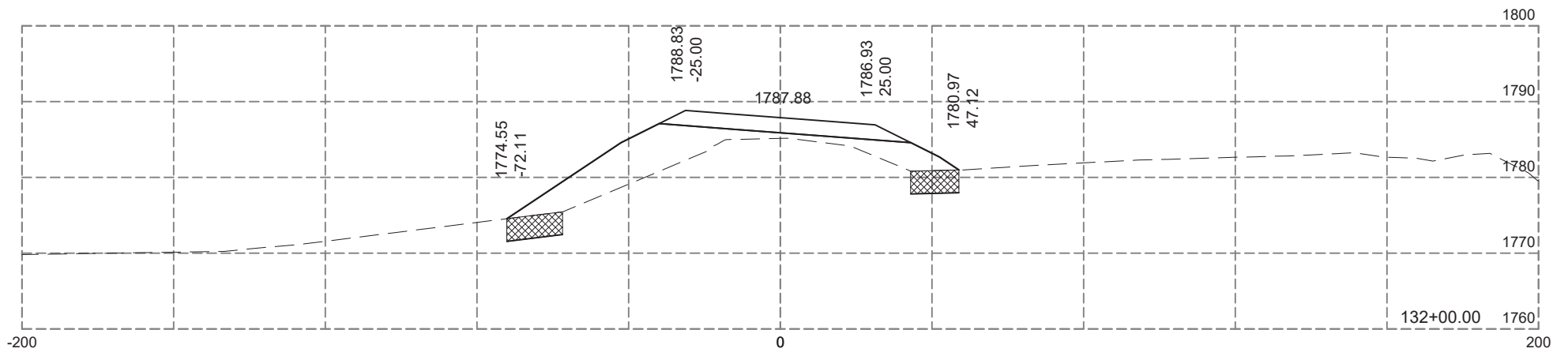
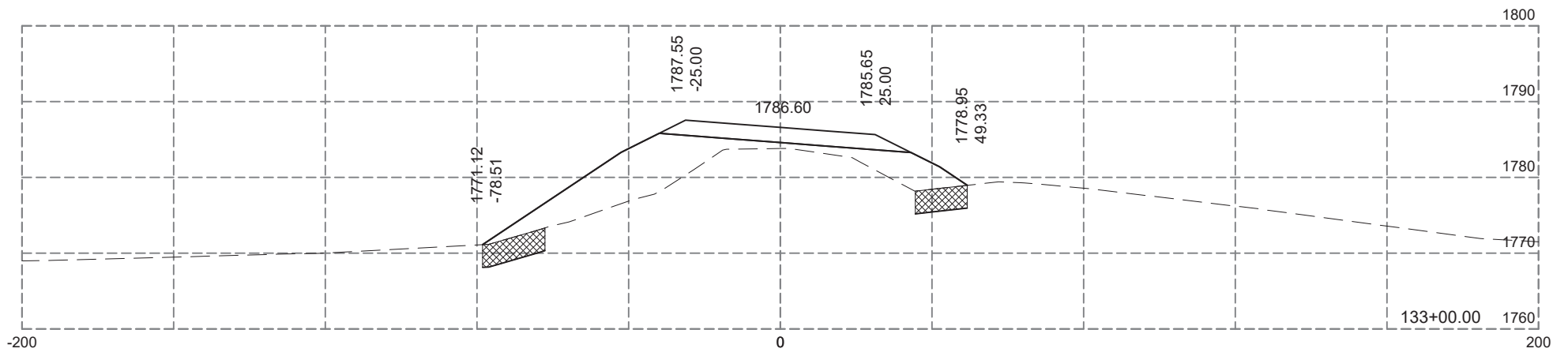
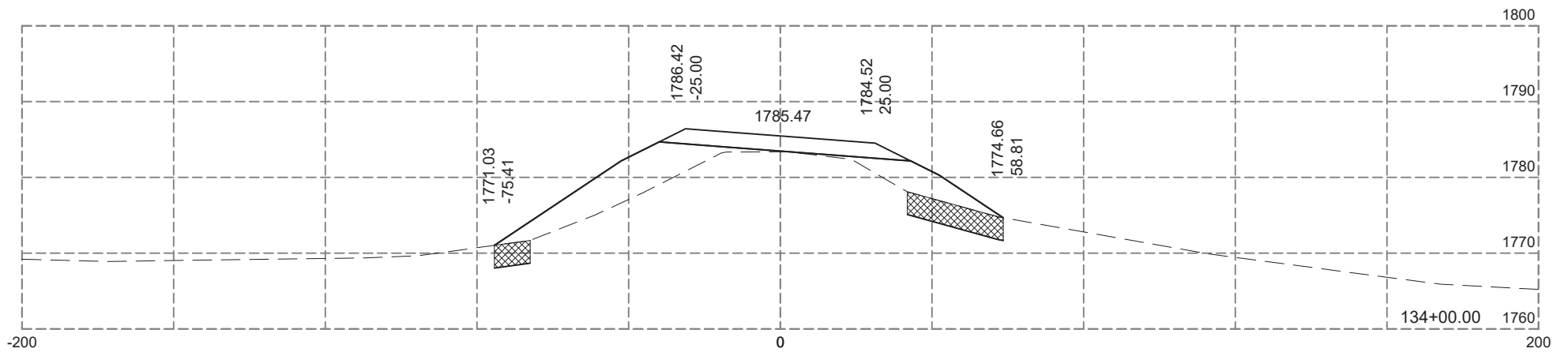
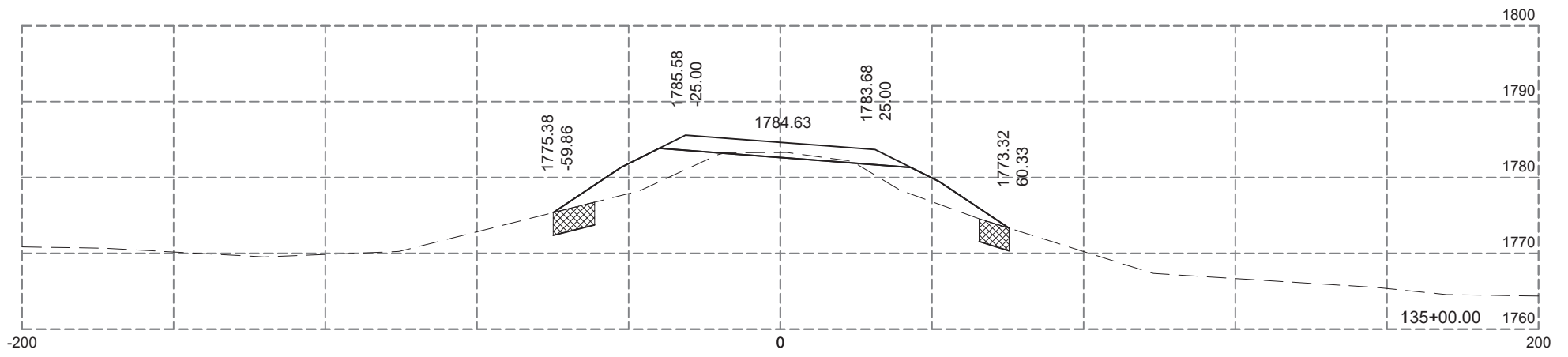
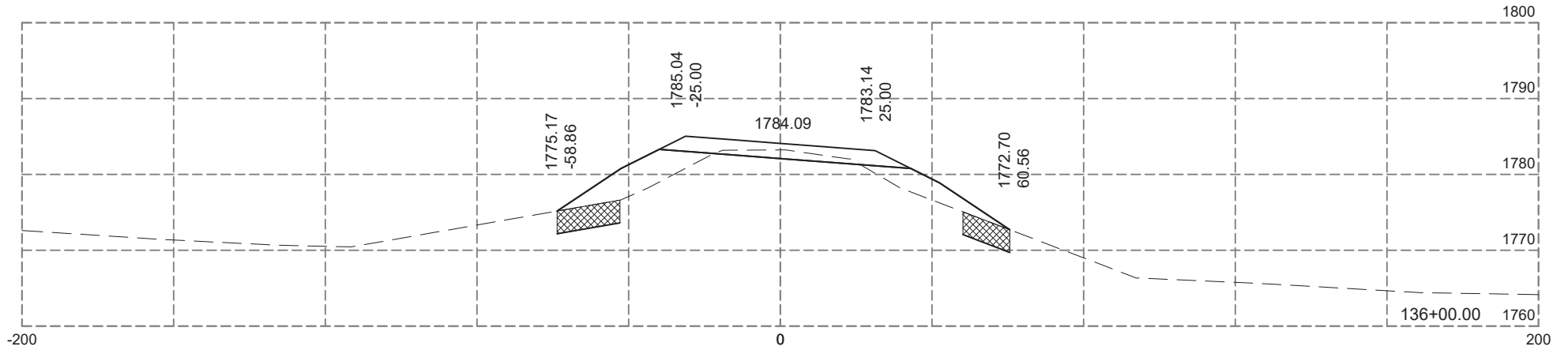

Plotting Date: 12-04-2024

STATE OF SOUTH DAKOTA	PROJECT P-PH-PT 0025(81)158	SHEET X74	TOTAL SHEETS X99
-----------------------	--------------------------------	--------------	---------------------



 Muck  
 Unstable



Plotting Date: 12-04-2024

STATE OF SOUTH DAKOTA	PROJECT	SHEET	TOTAL SHEETS
	P-PH-PT 0025(81)158	X75	X99

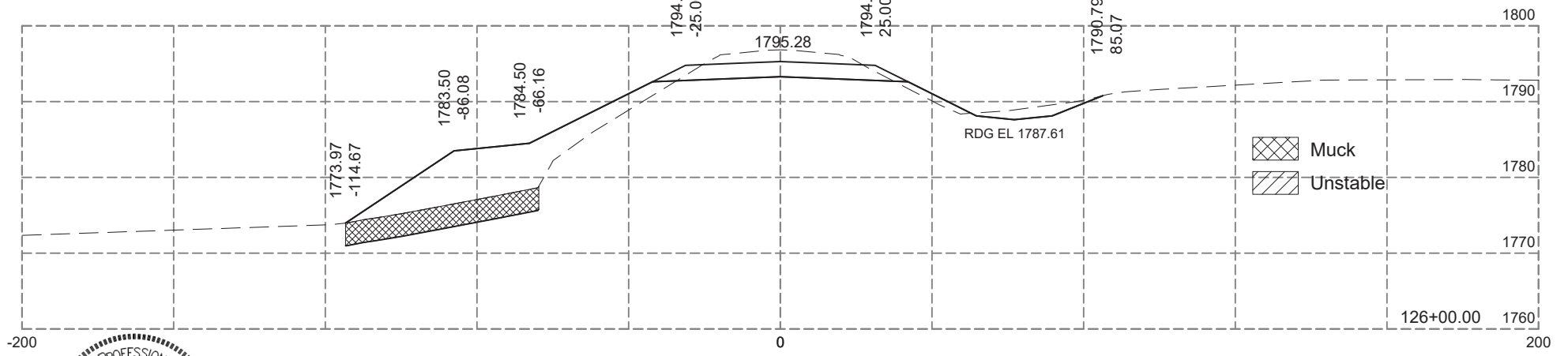
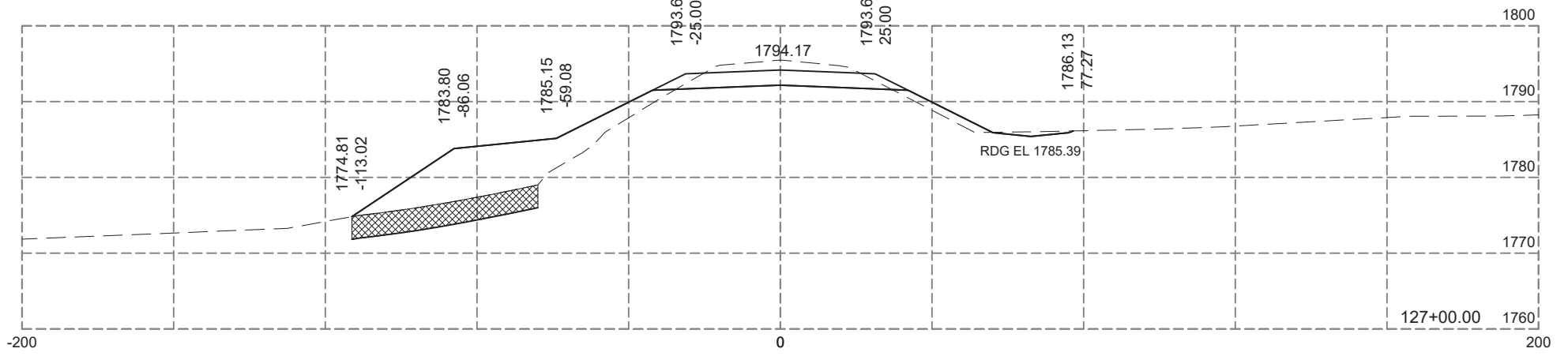
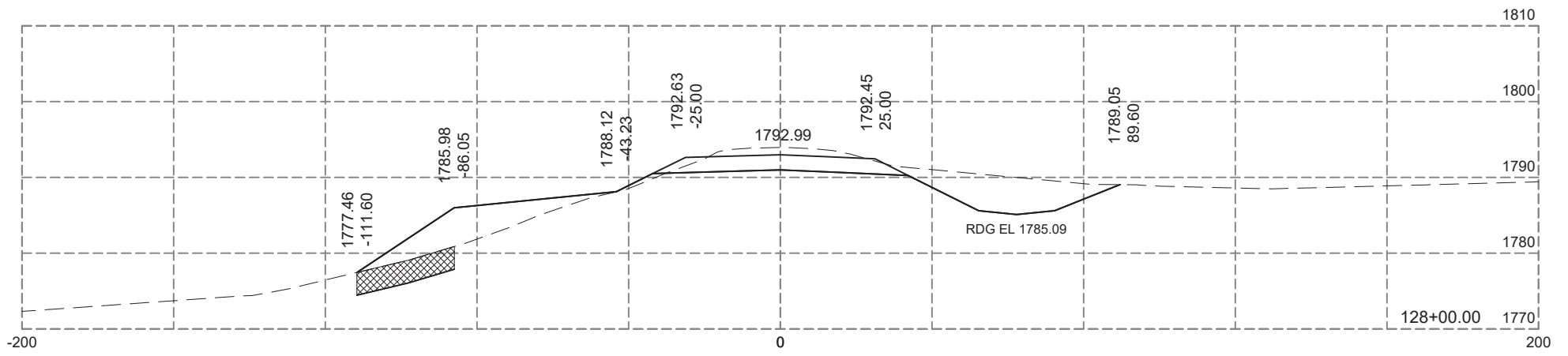
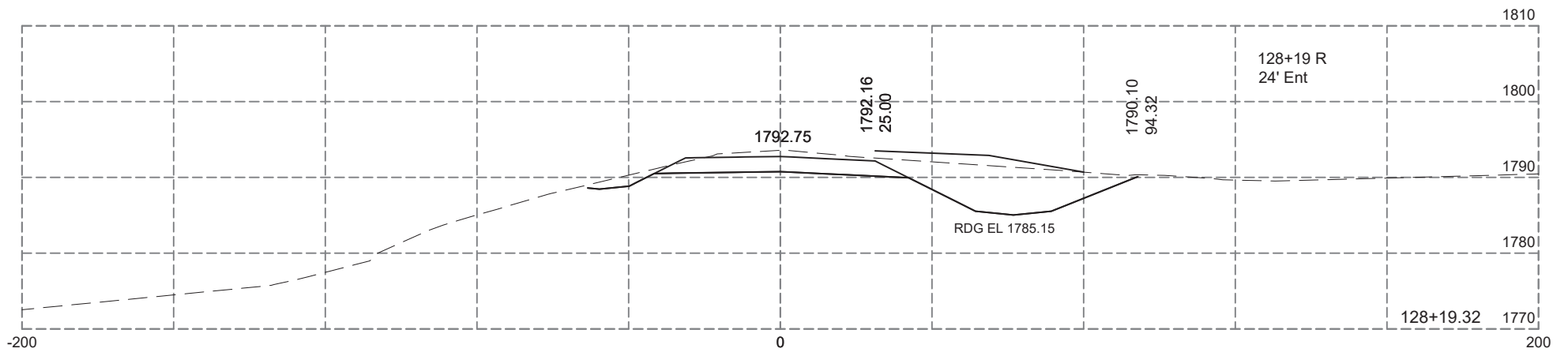
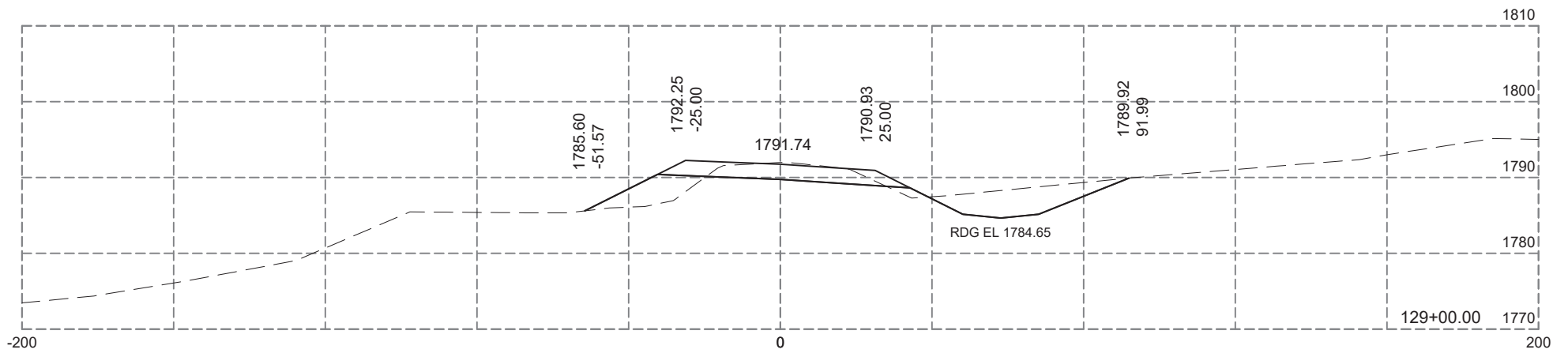
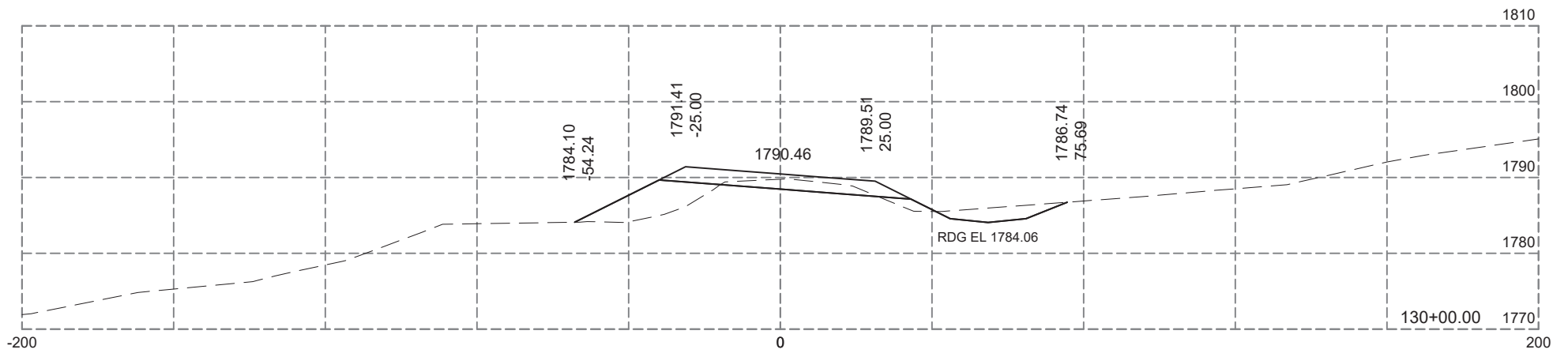

Plotting Date: 12-04-2024

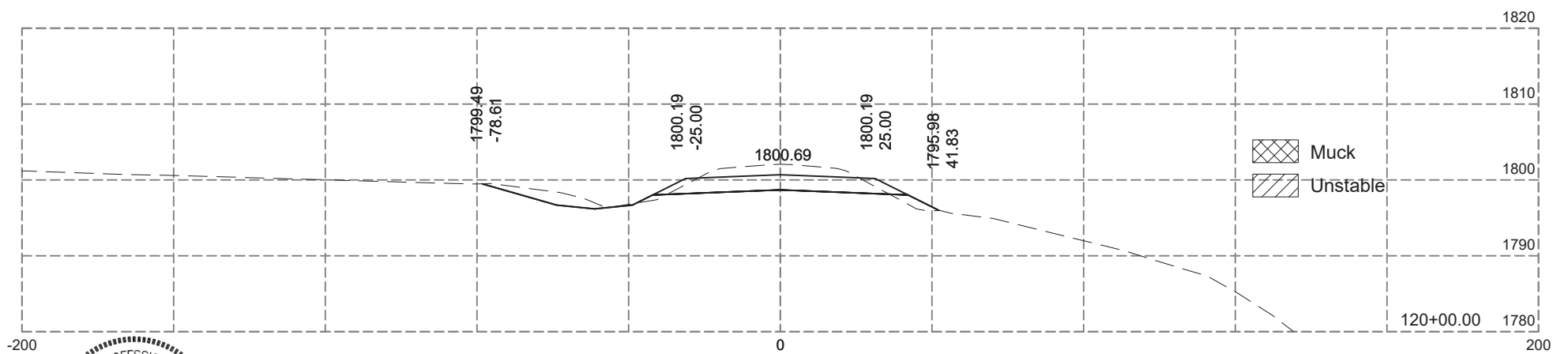
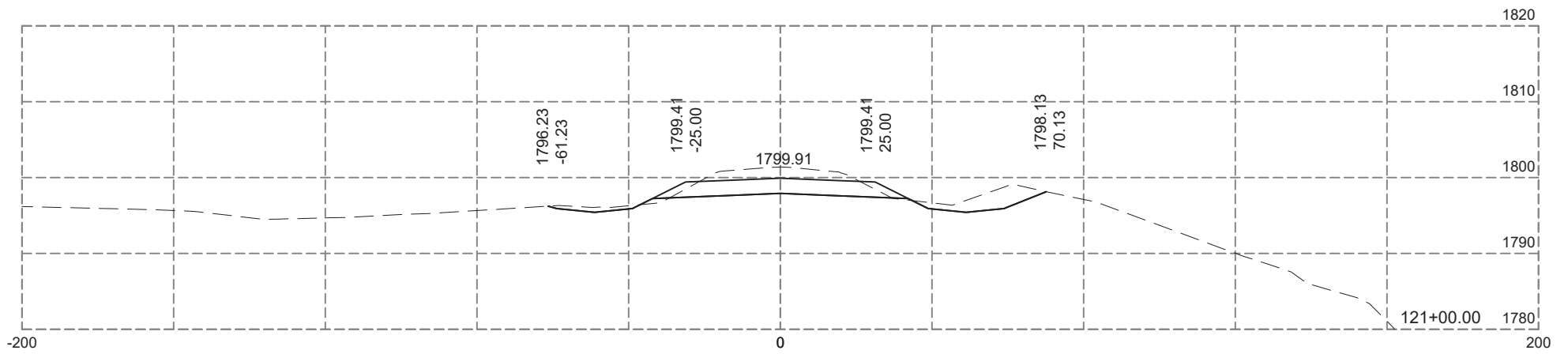
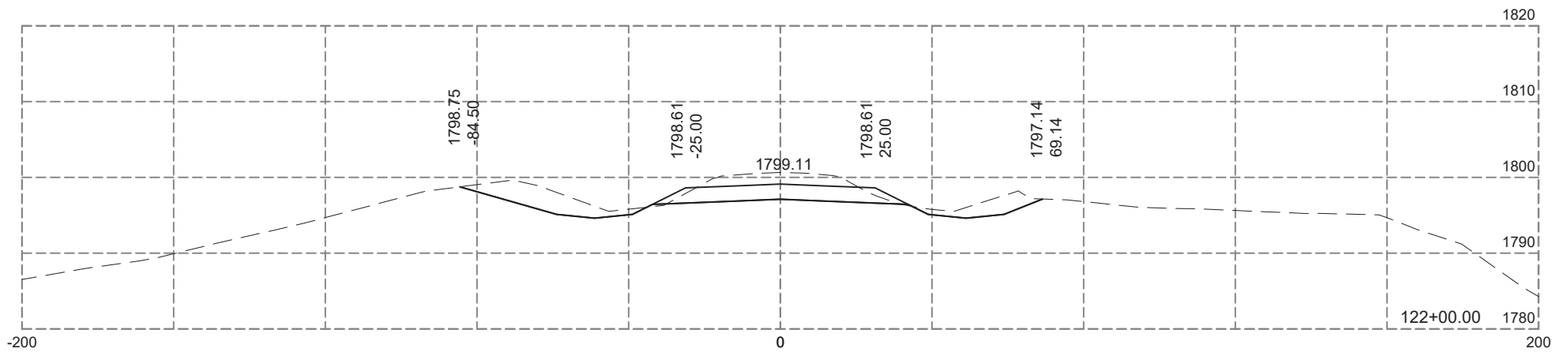
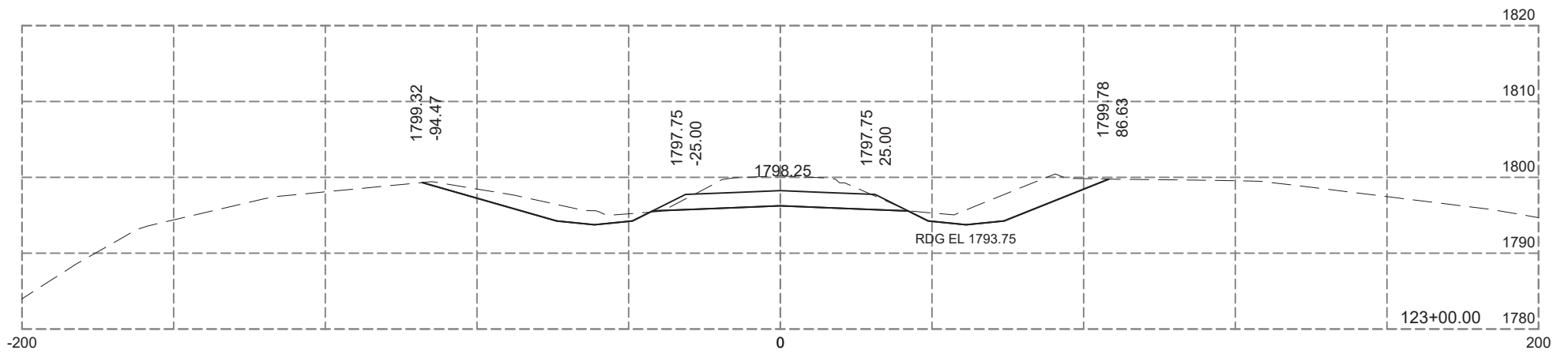
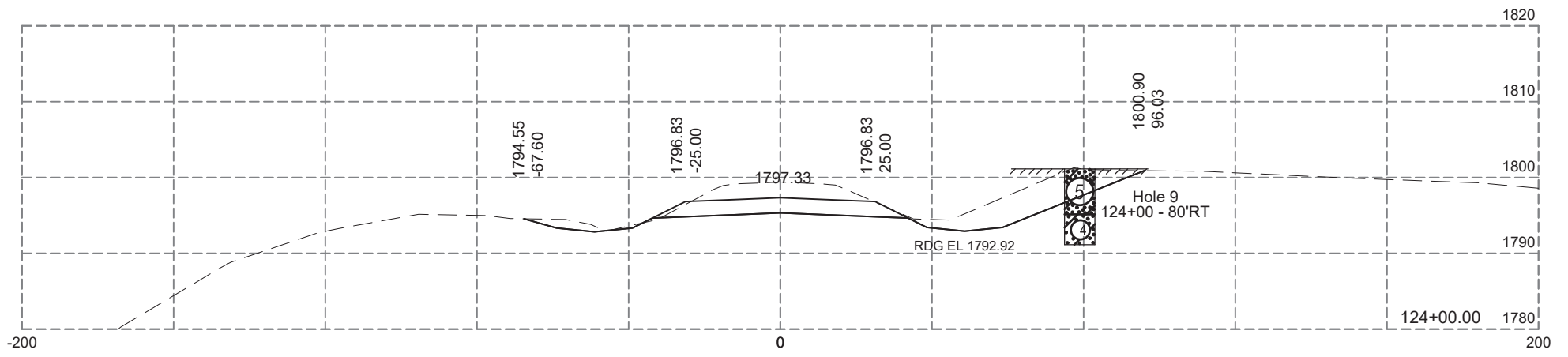
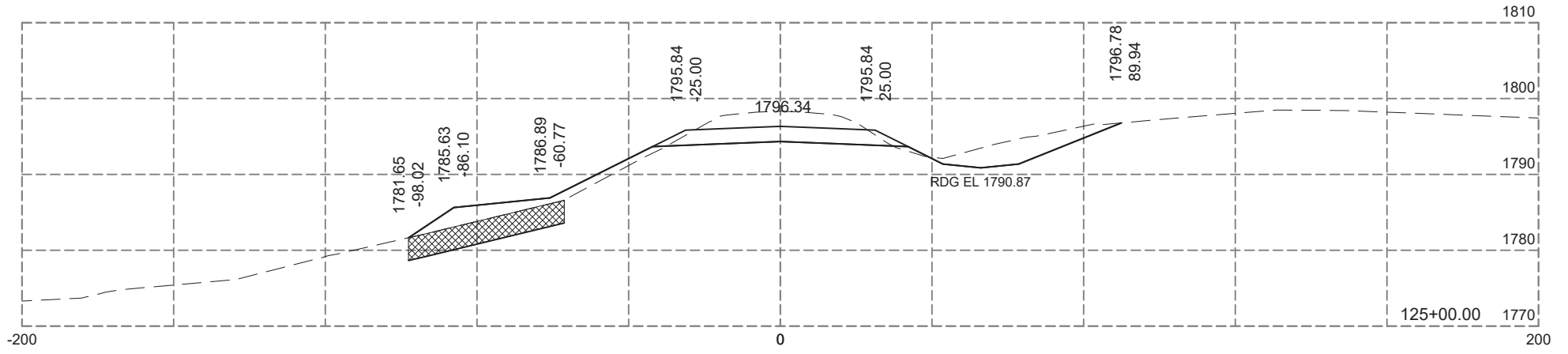

STATE OF SOUTH DAKOTA	PROJECT P-PH-PT 0025(81)158	SHEET X76	TOTAL SHEETS X99
-----------------------	--------------------------------	--------------	---------------------

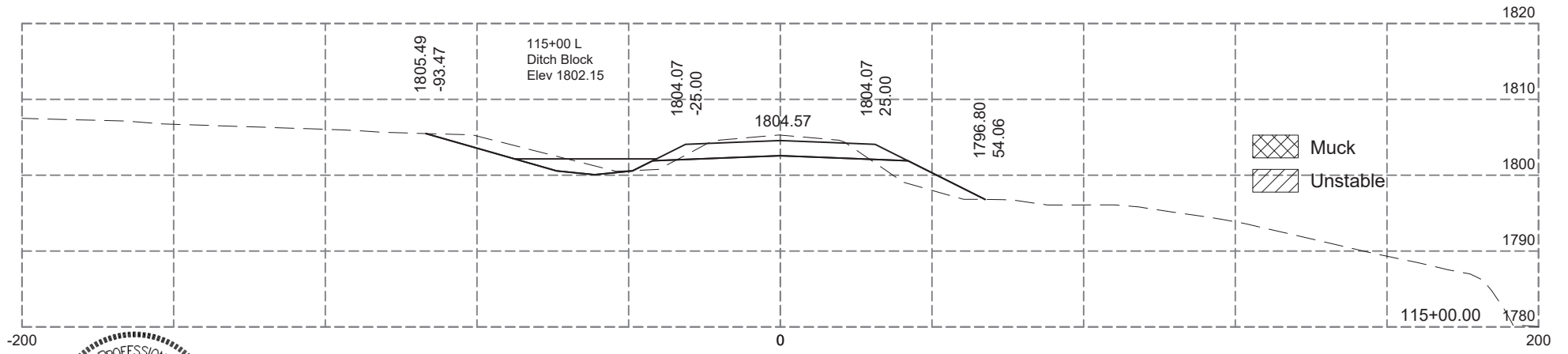
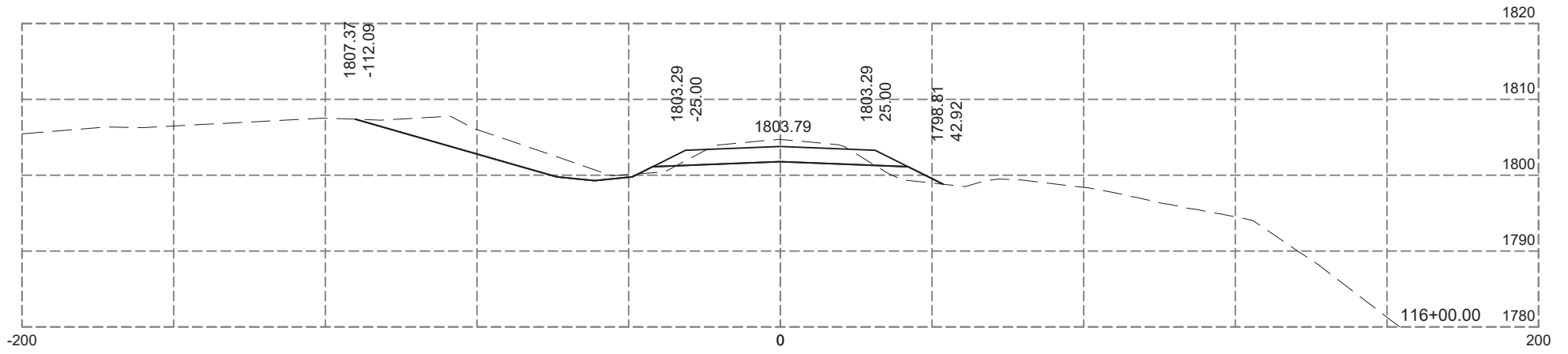
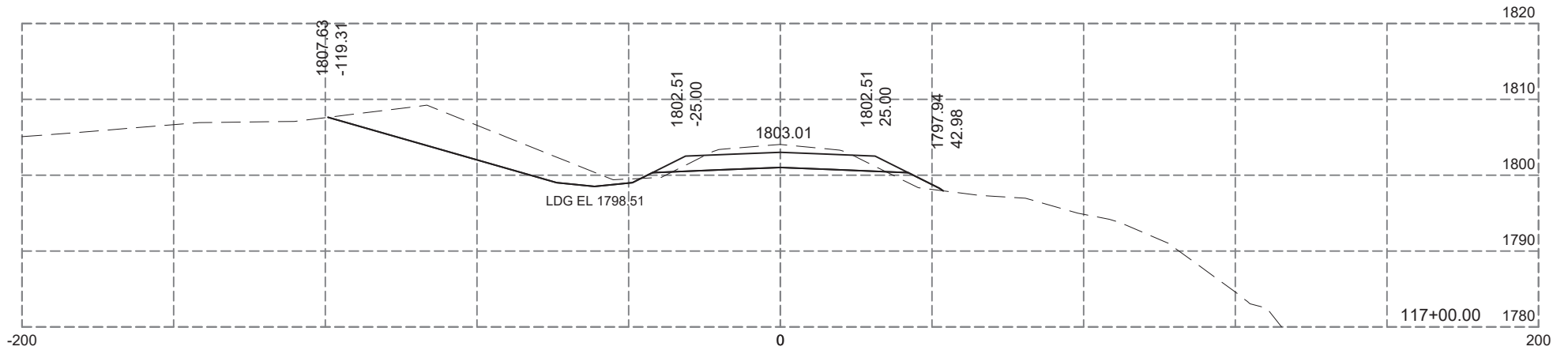
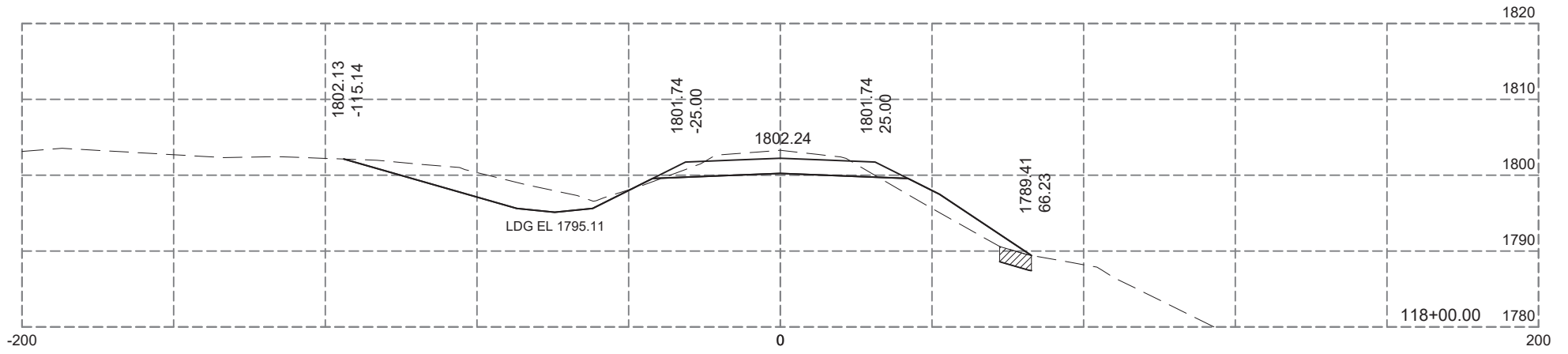
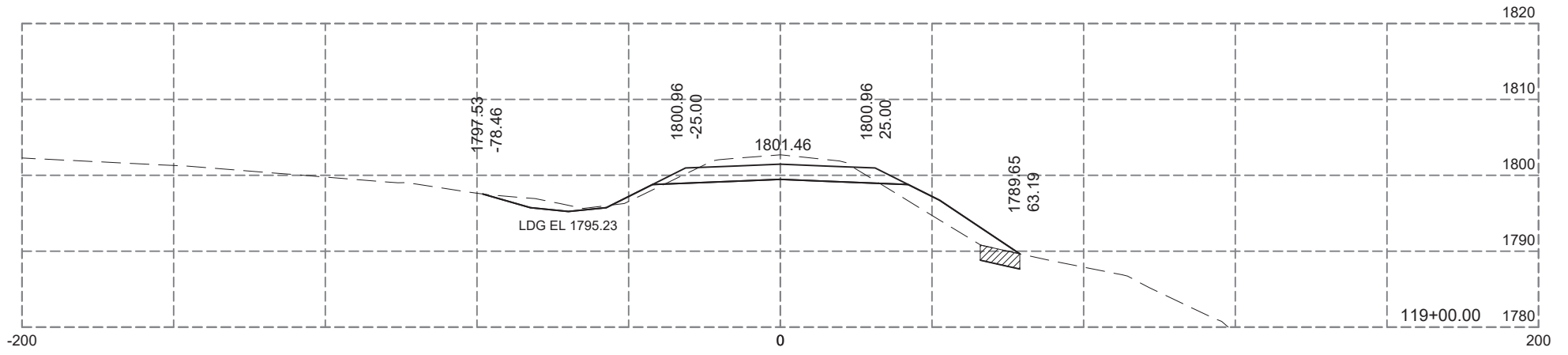
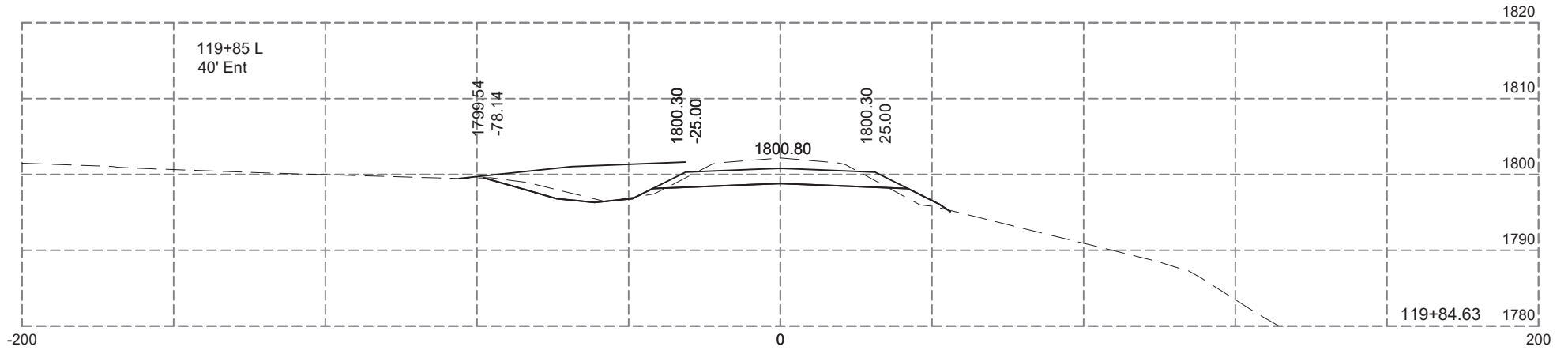

Plotting Date: 12-04-2024

STATE OF SOUTH DAKOTA	PROJECT P-PH-PT 0025(81)158	SHEET X77	TOTAL SHEETS X99
-----------------------	--------------------------------	--------------	---------------------



 Muck  
 Unstable



Plotting Date: 12-04-2024

STATE OF SOUTH DAKOTA	PROJECT	SHEET	TOTAL SHEETS
	P-PH-PT 0025(81)158	X78	X99

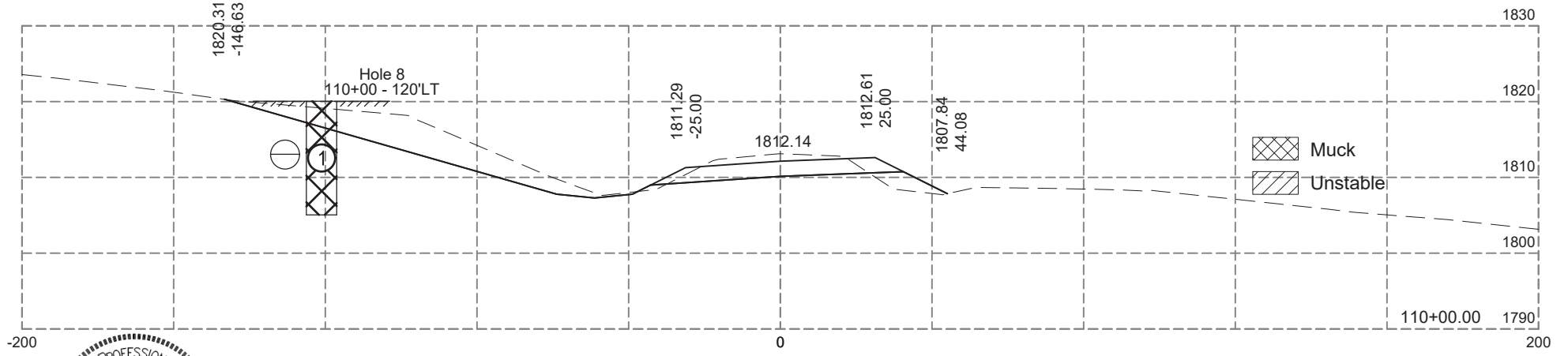
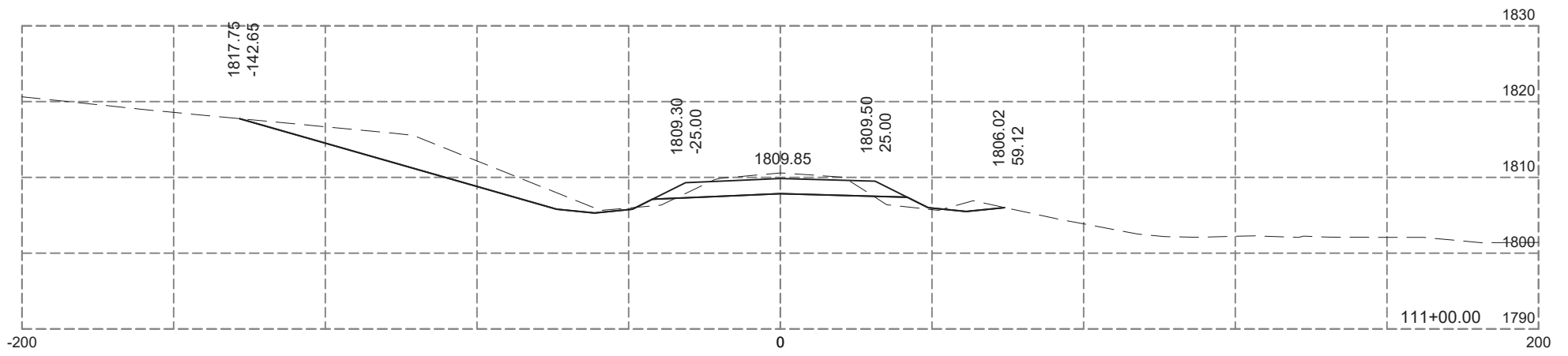
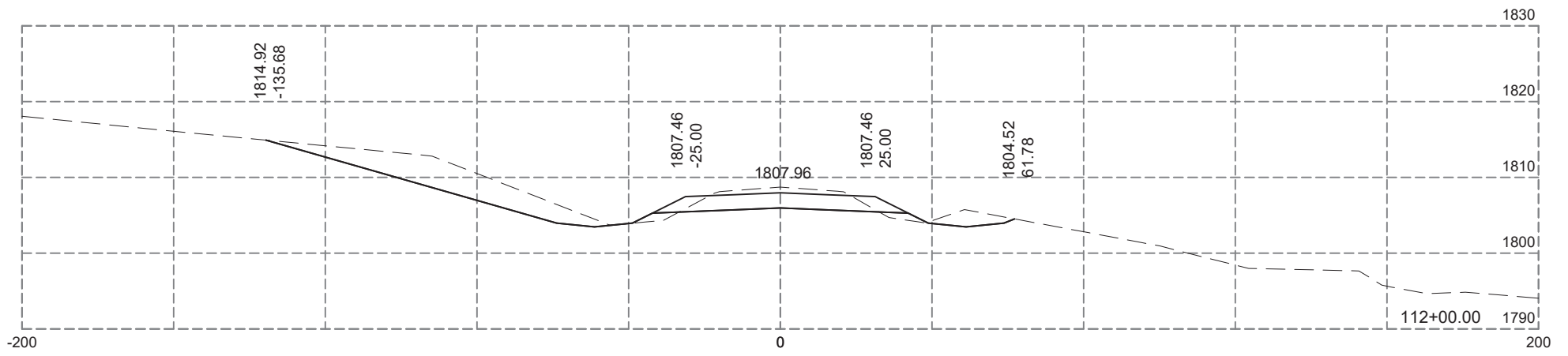
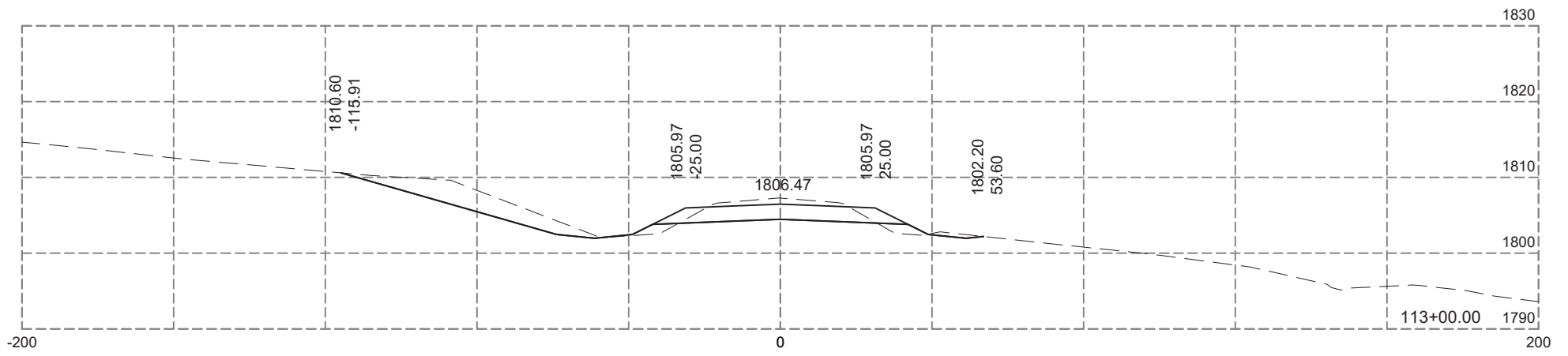
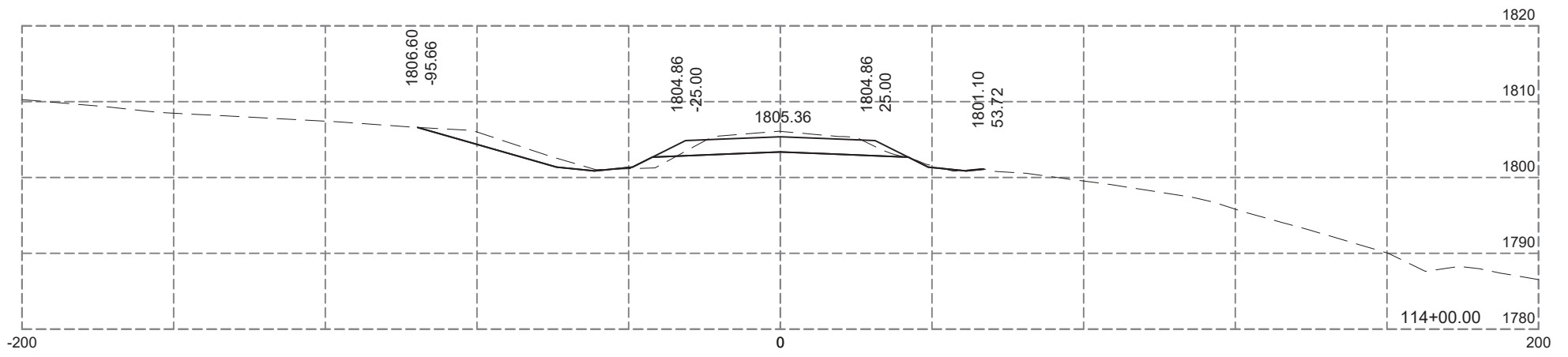
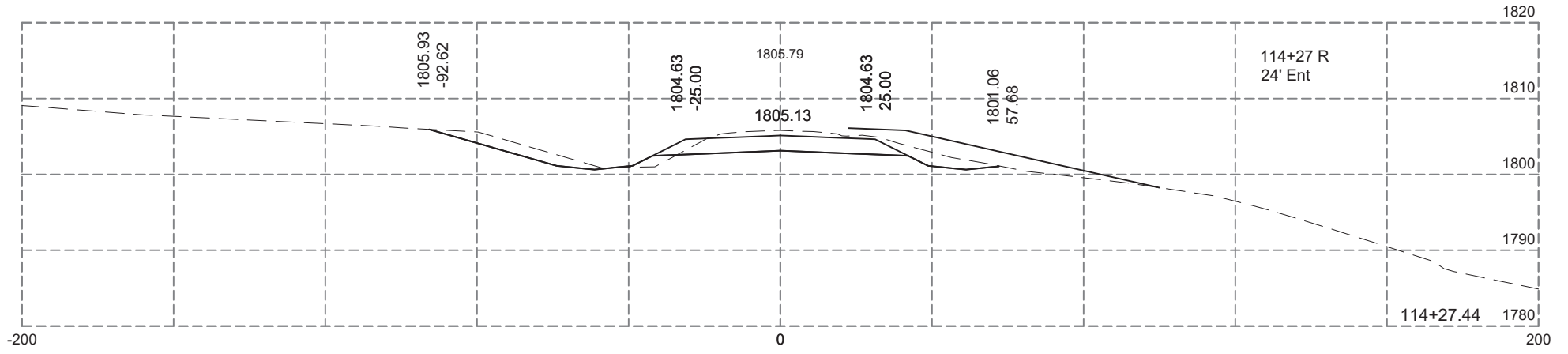

Plotting Date: 12-04-2024

STATE OF SOUTH DAKOTA	PROJECT P-PH-PT 0025(81)158	SHEET X79	TOTAL SHEETS X99
-----------------------	--------------------------------	--------------	---------------------

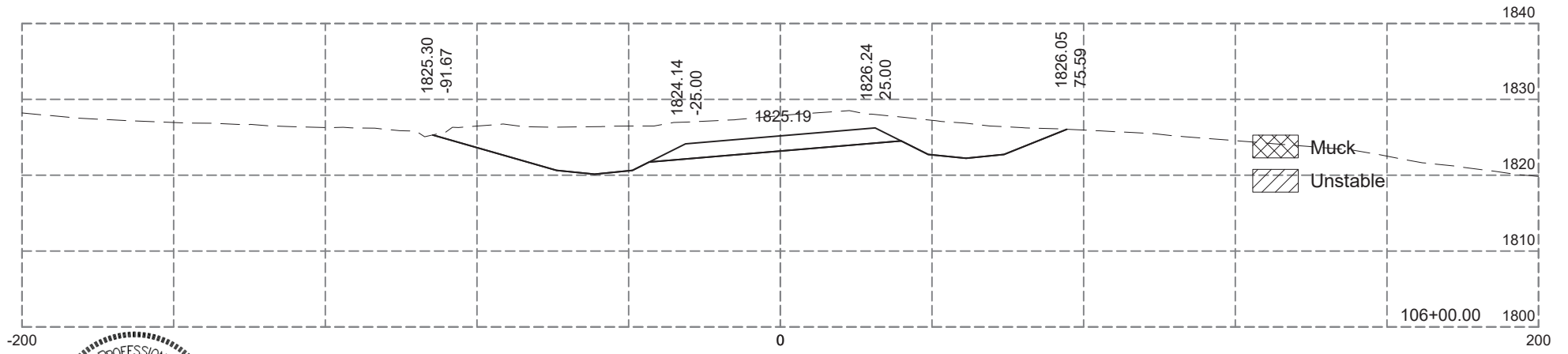
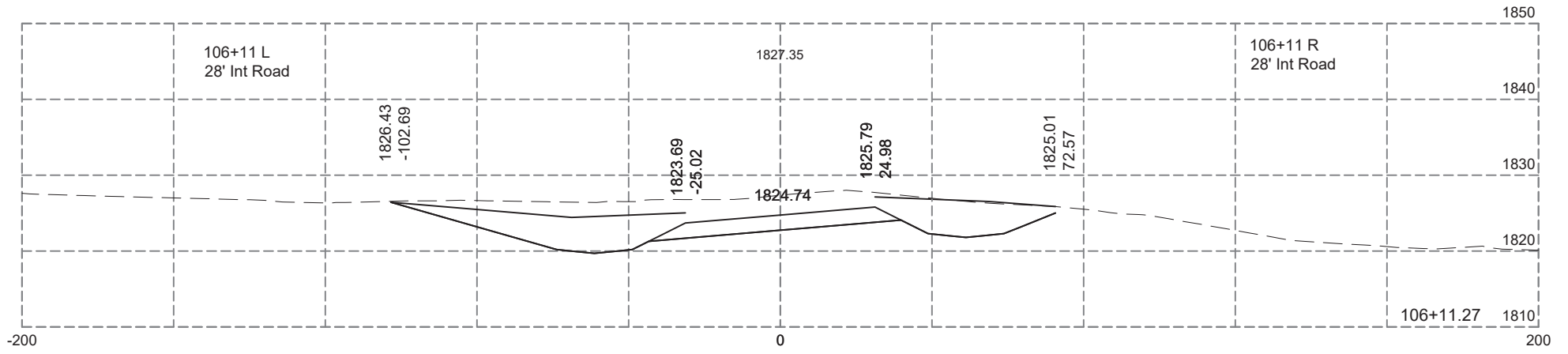
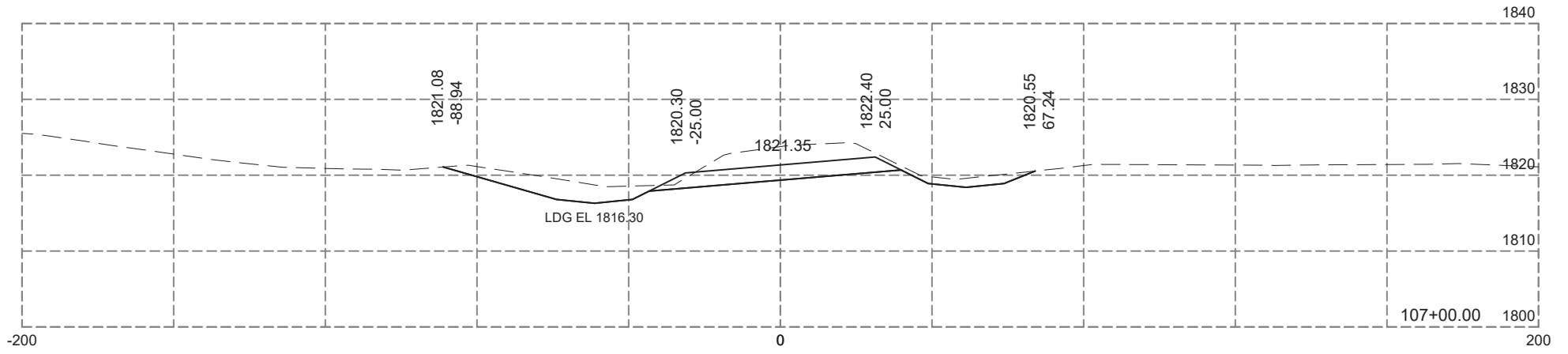
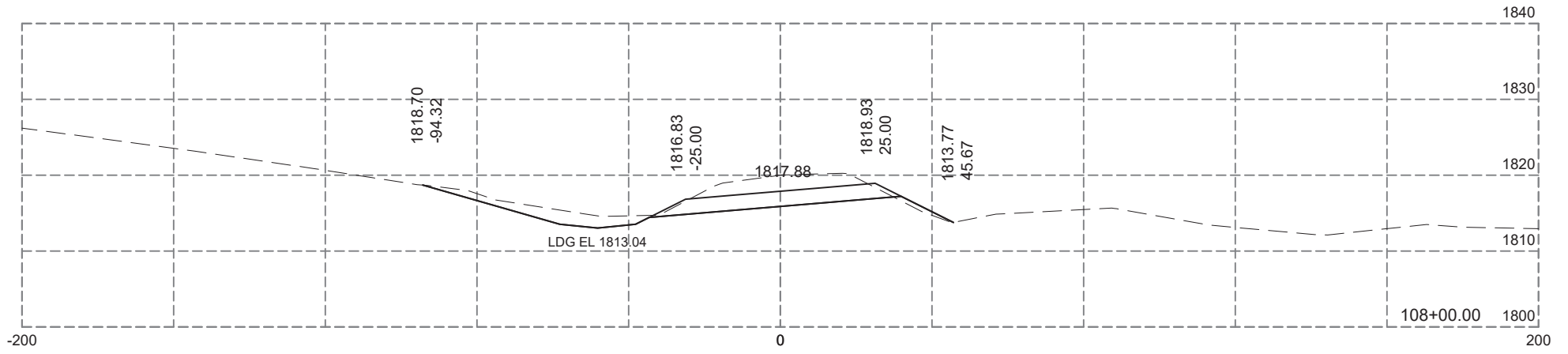
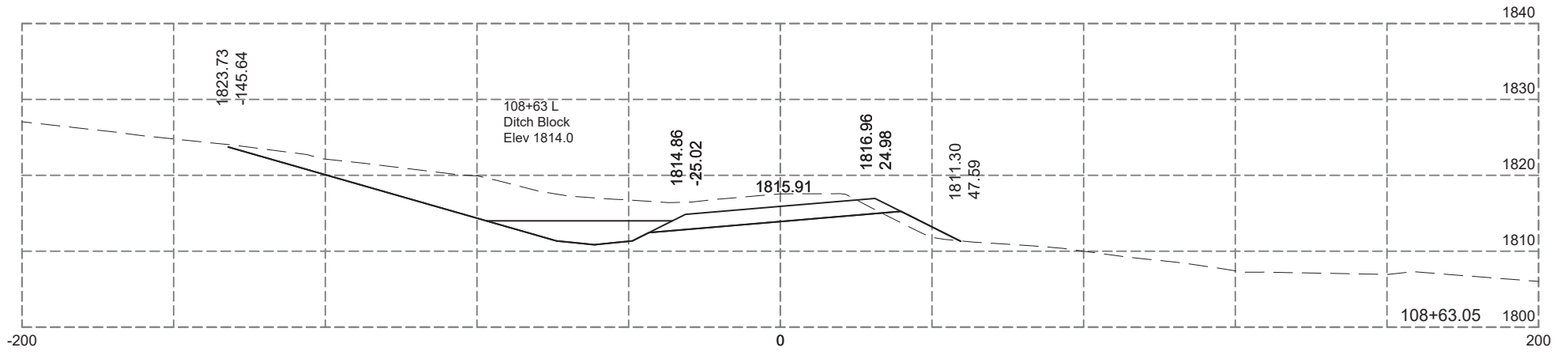
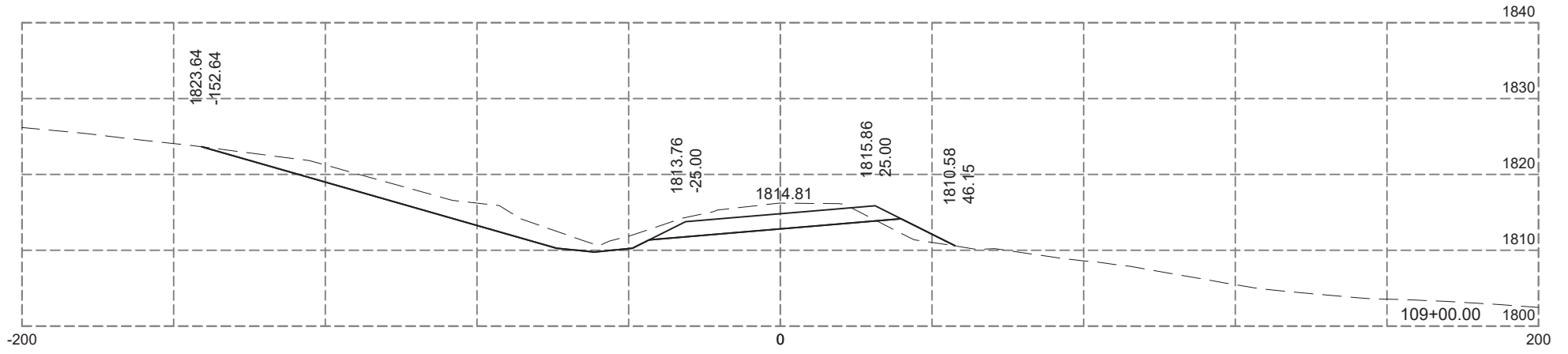

Plotting Date: 12-04-2024

STATE OF SOUTH DAKOTA	PROJECT	SHEET	TOTAL SHEETS
	P-PH-PT 0025(81)158	X80	X99



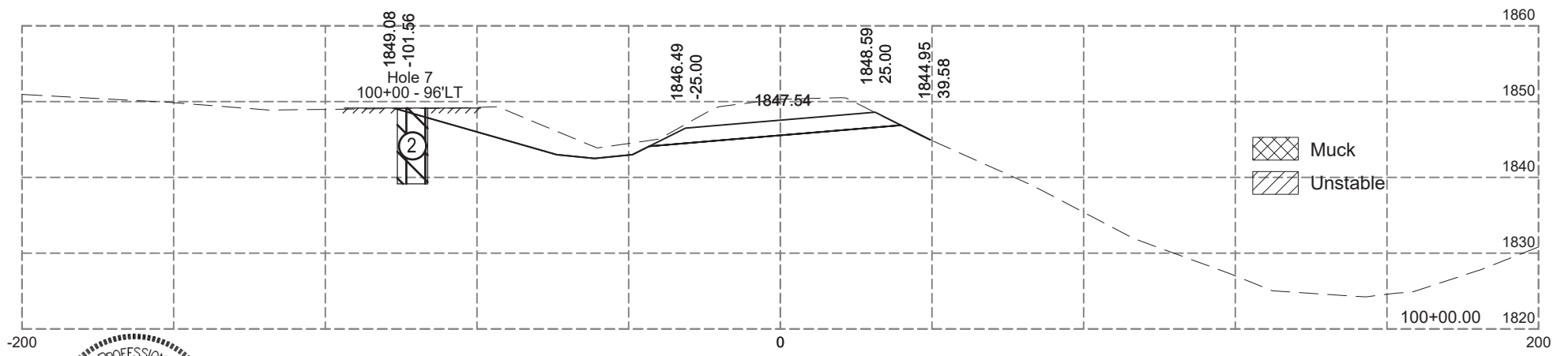
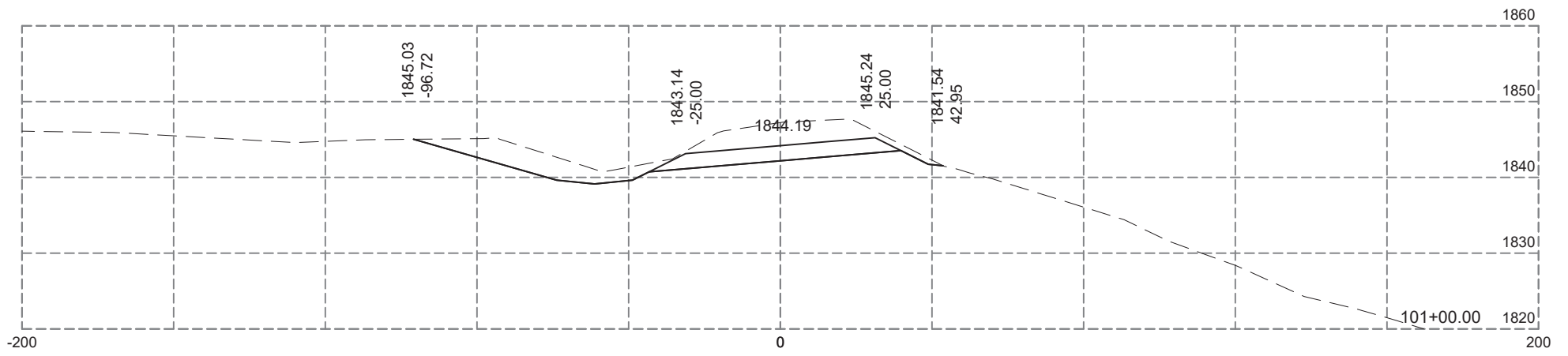
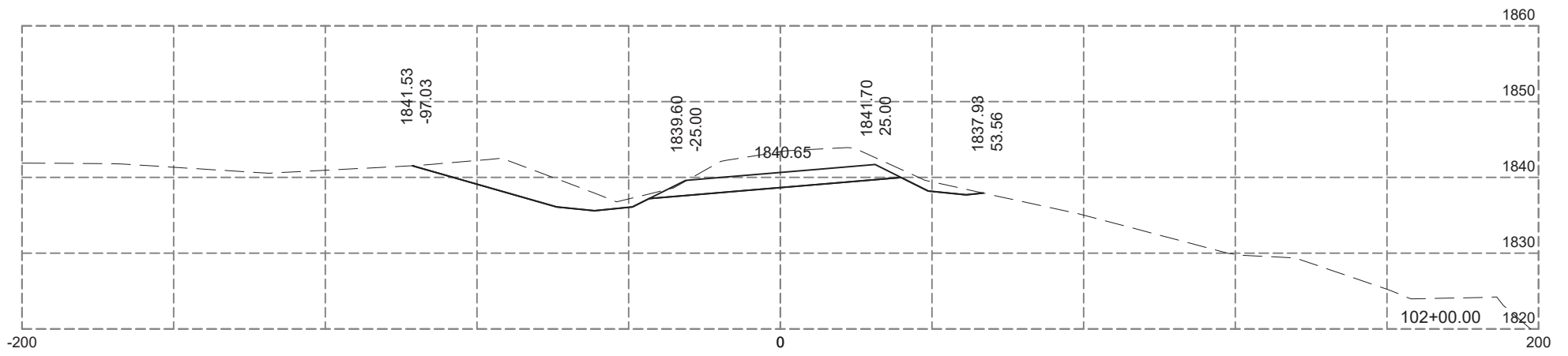
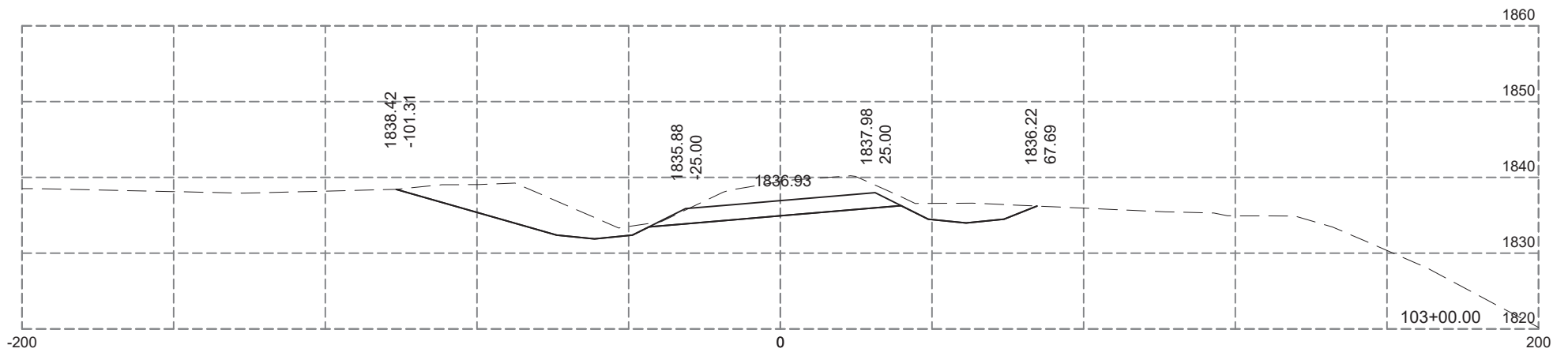
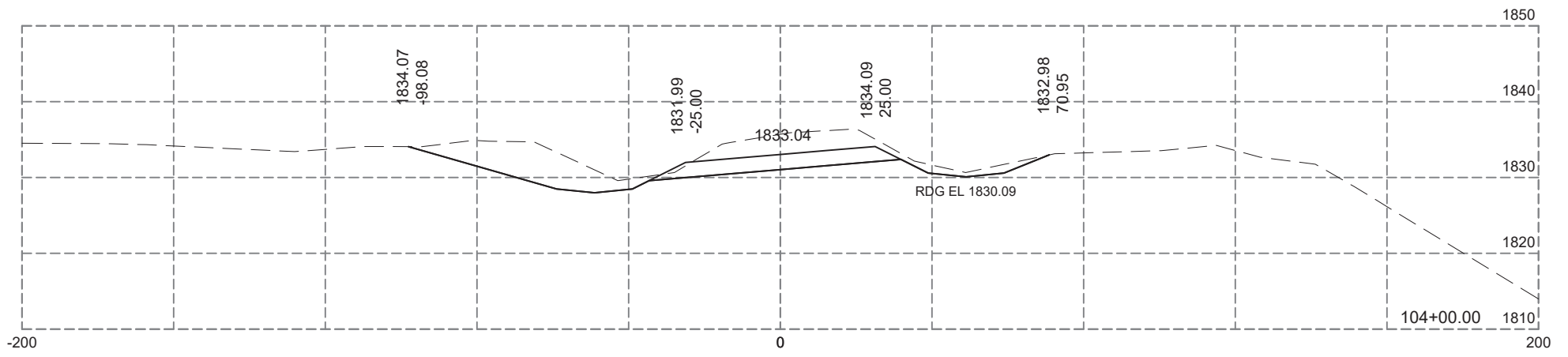
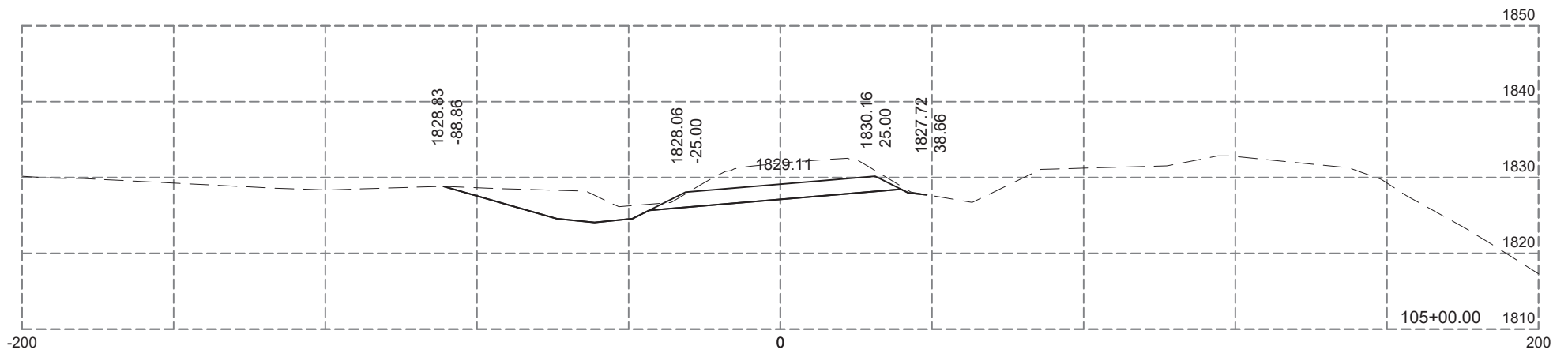

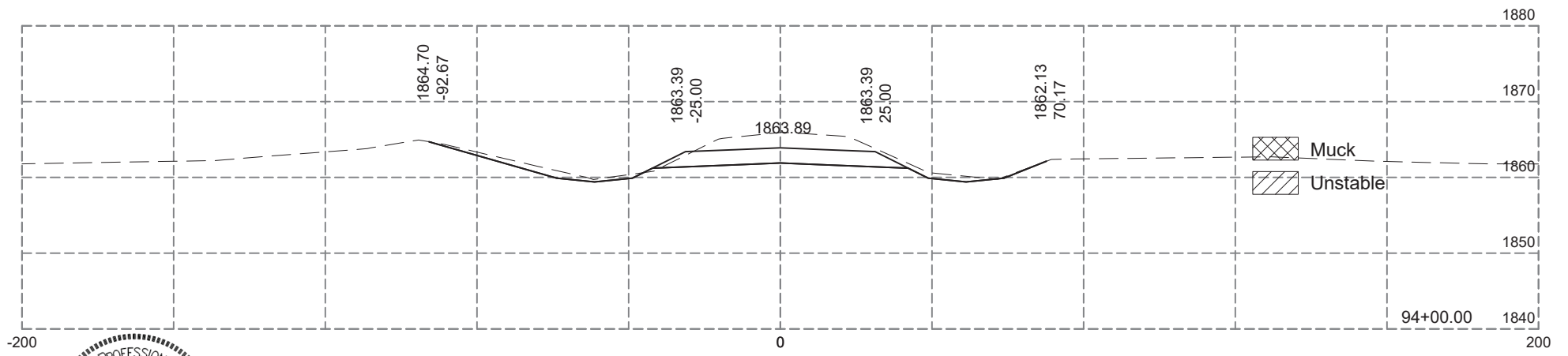
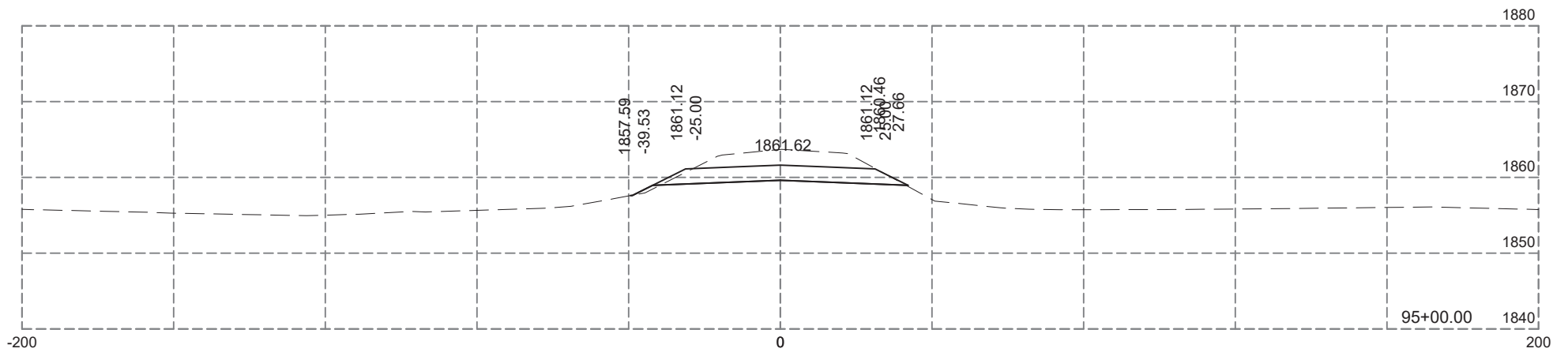
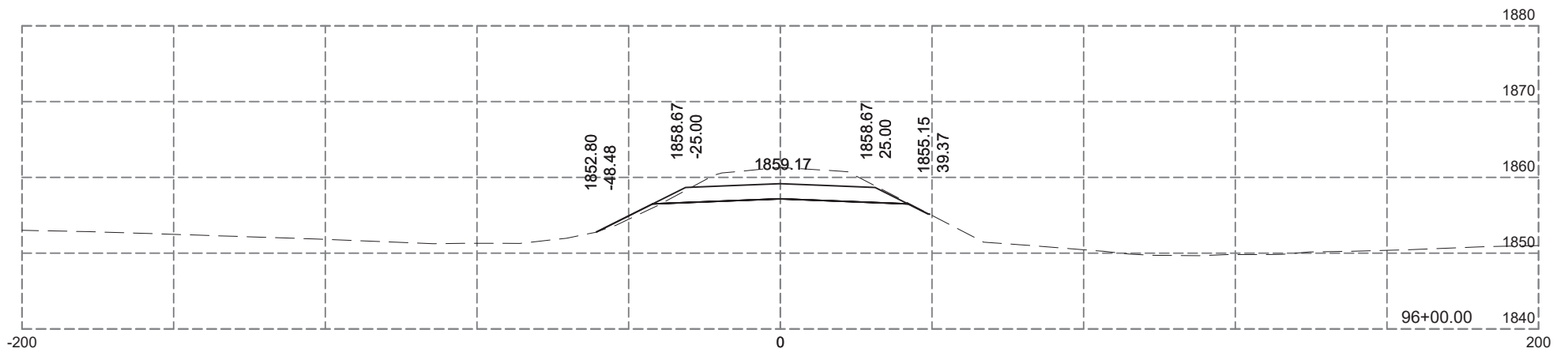
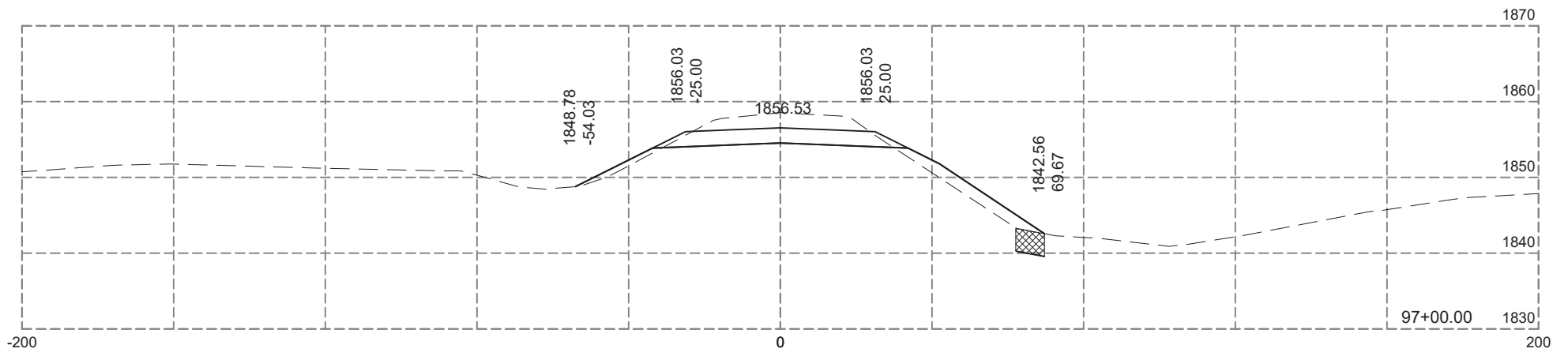
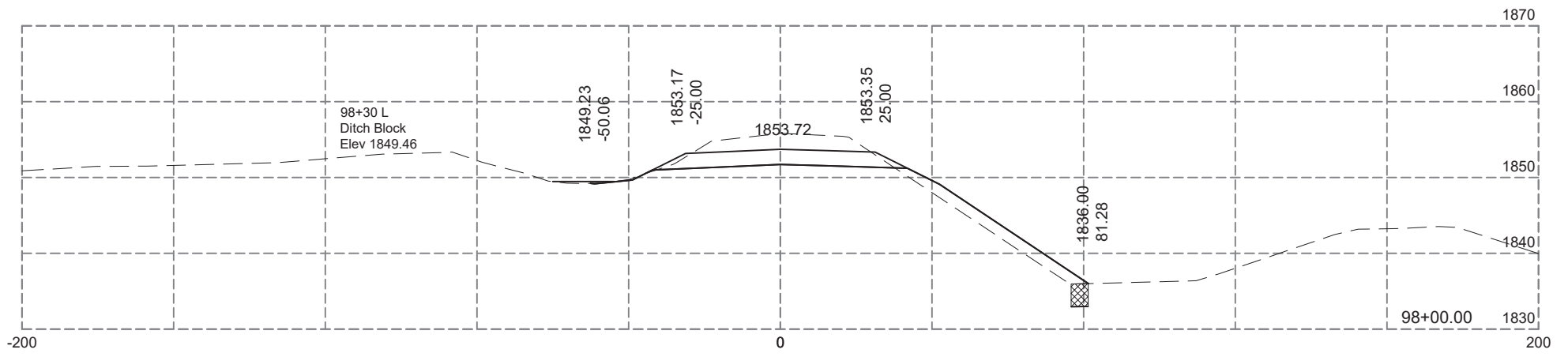
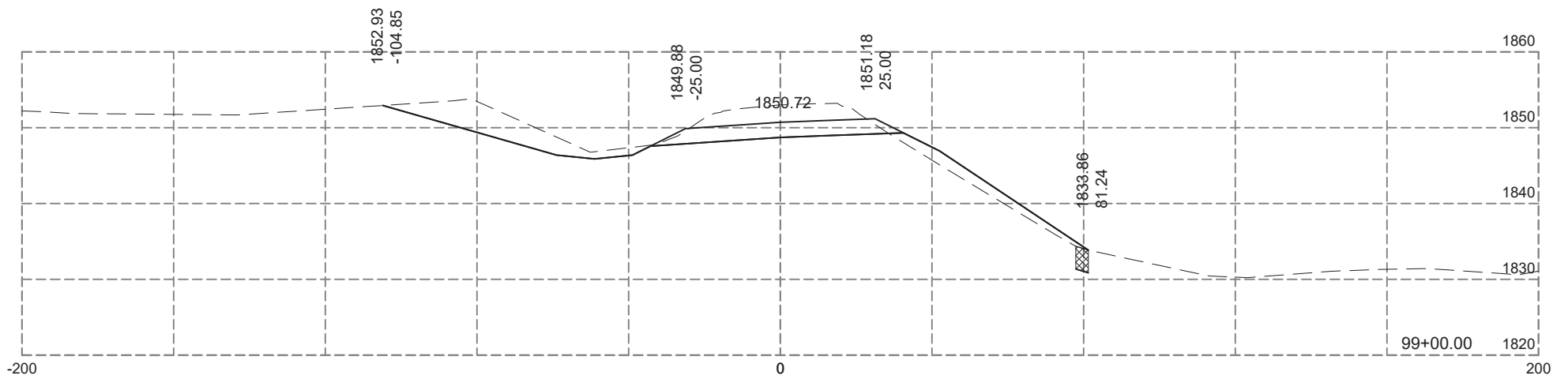

Plotting Date: 12-04-2024

STATE OF SOUTH DAKOTA	PROJECT P-PH-PT 0025(81)158	SHEET X81	TOTAL SHEETS X99
-----------------------	--------------------------------	--------------	---------------------



 Muck  
 Unstable



Plotting Date: 12-04-2024

STATE OF SOUTH DAKOTA	PROJECT	SHEET	TOTAL SHEETS
	P-PH-PT 0025(81)158	X82	X99

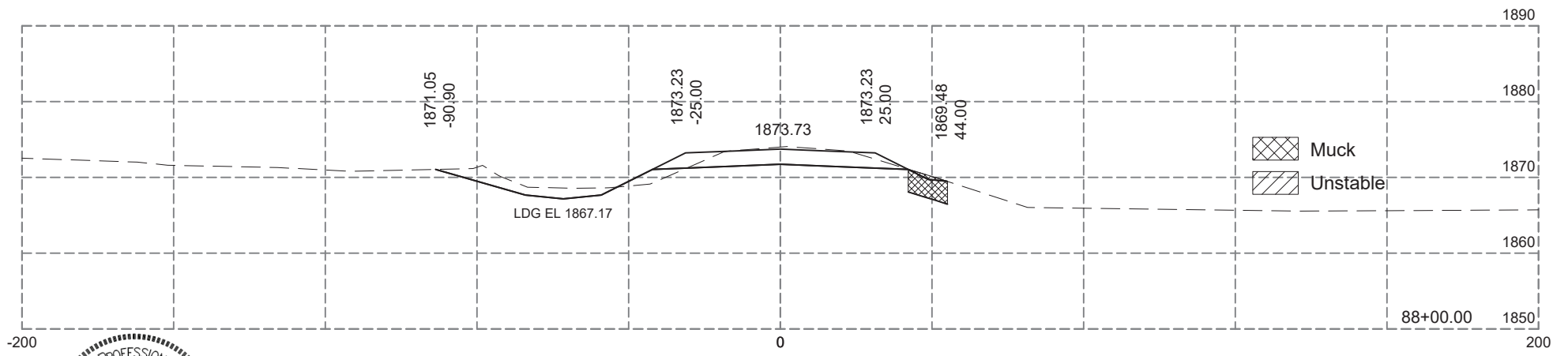
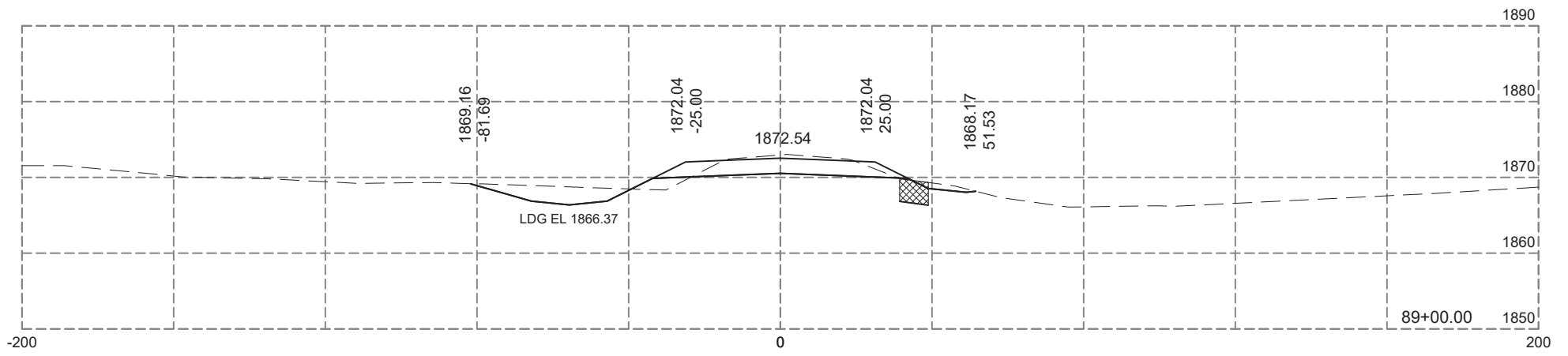
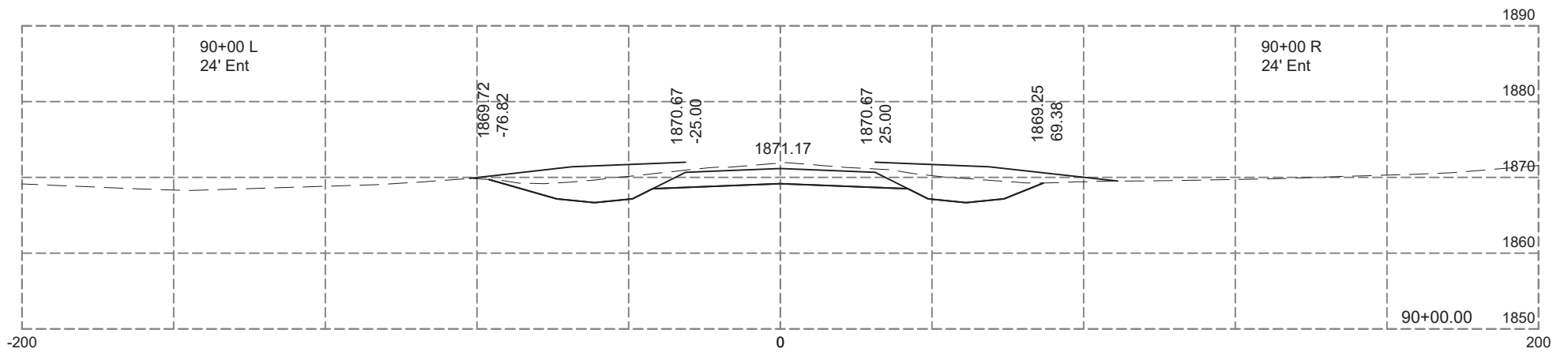
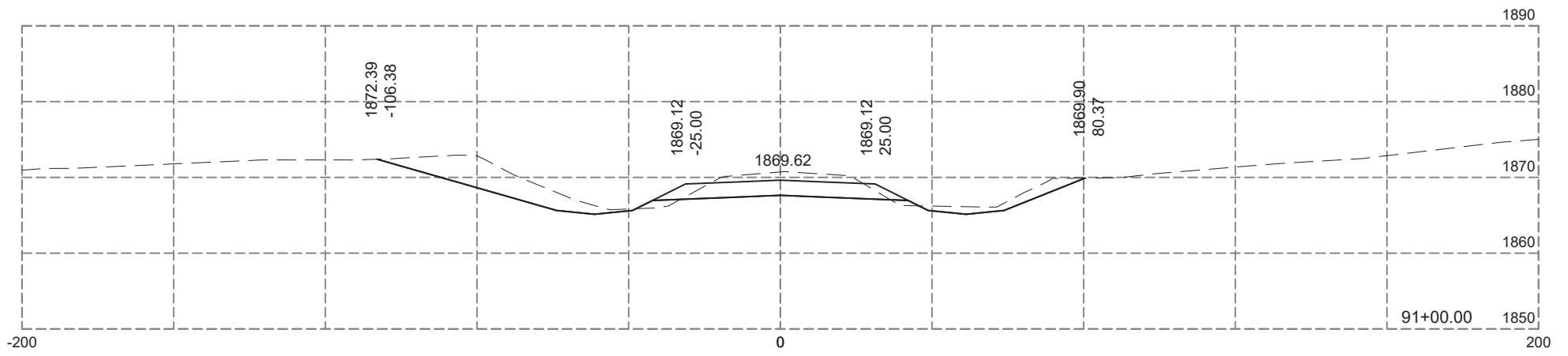
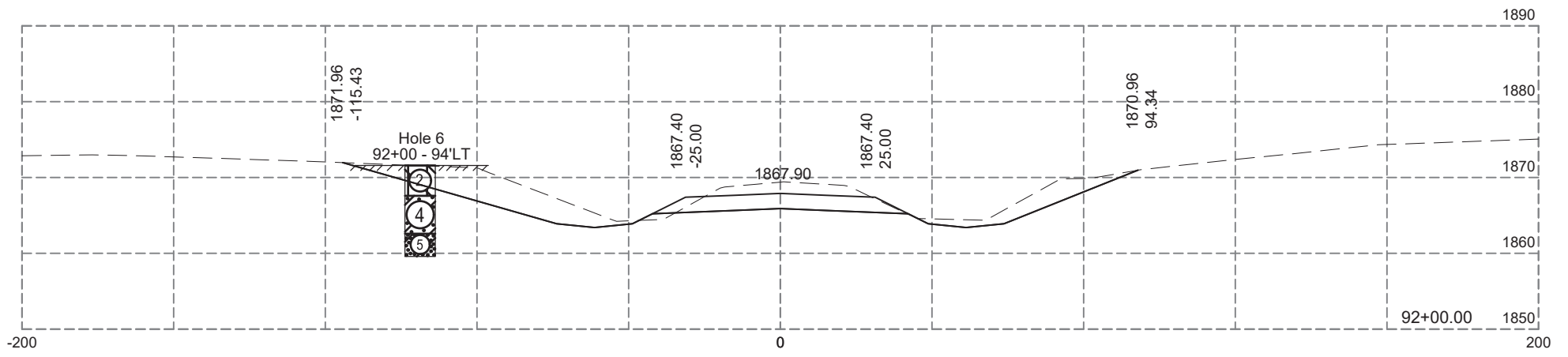
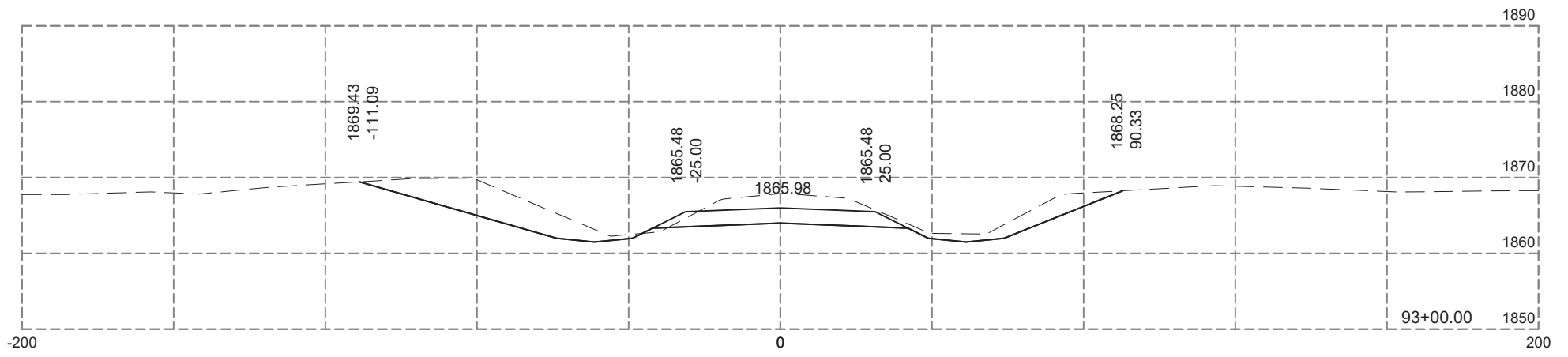

Plotting Date: 12-04-2024

STATE OF SOUTH DAKOTA	PROJECT P-PH-PT 0025(81)158	SHEET X83	TOTAL SHEETS X99
-----------------------	--------------------------------	--------------	---------------------

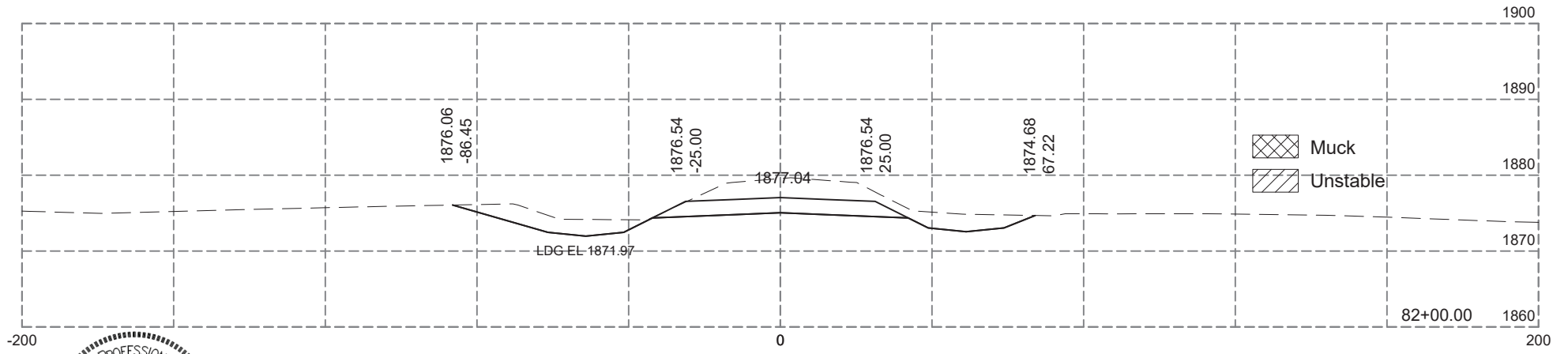
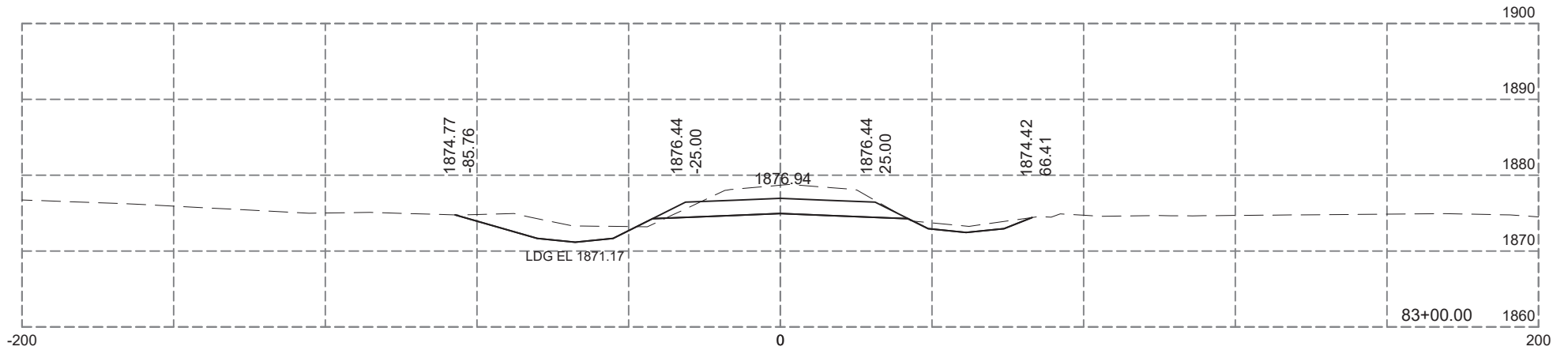
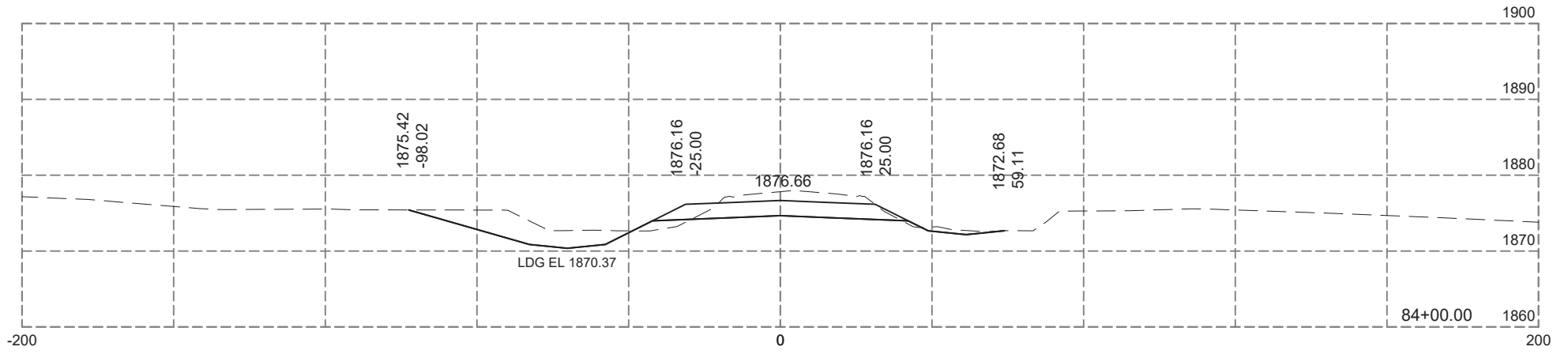
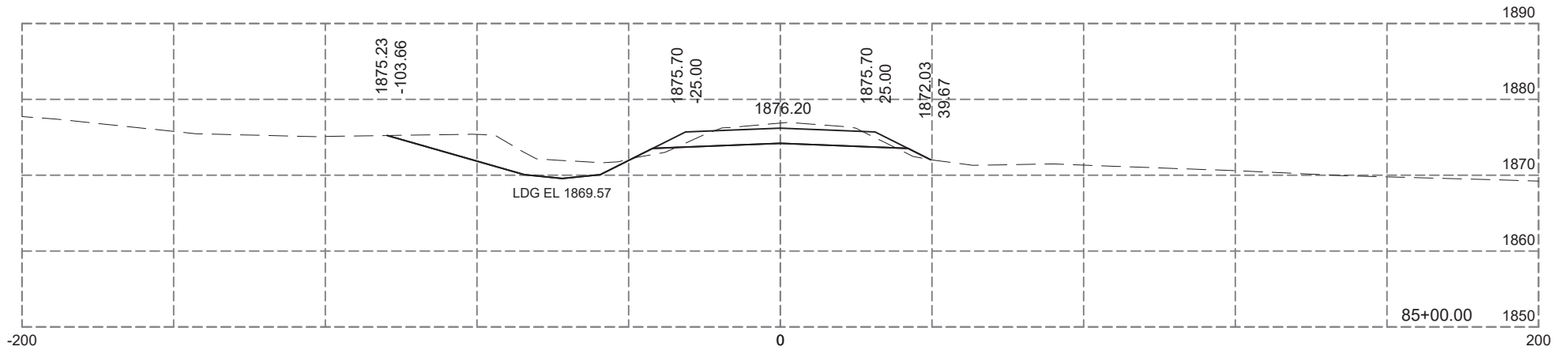
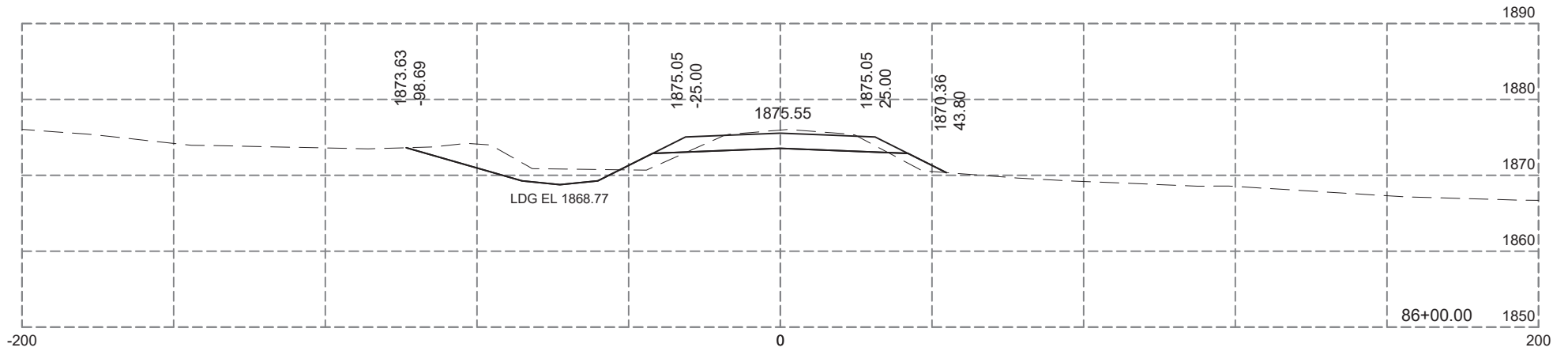
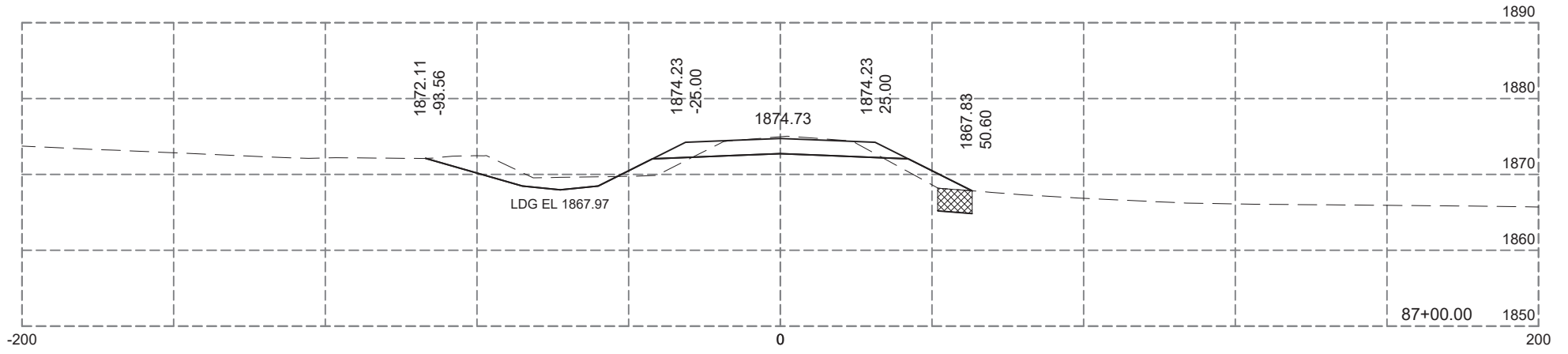

Muck  
 Unstable



Plotting Date: 12-04-2024

STATE OF SOUTH DAKOTA	PROJECT P-PH-PT 0025(81)158	SHEET X84	TOTAL SHEETS X99
-----------------------	--------------------------------	--------------	---------------------

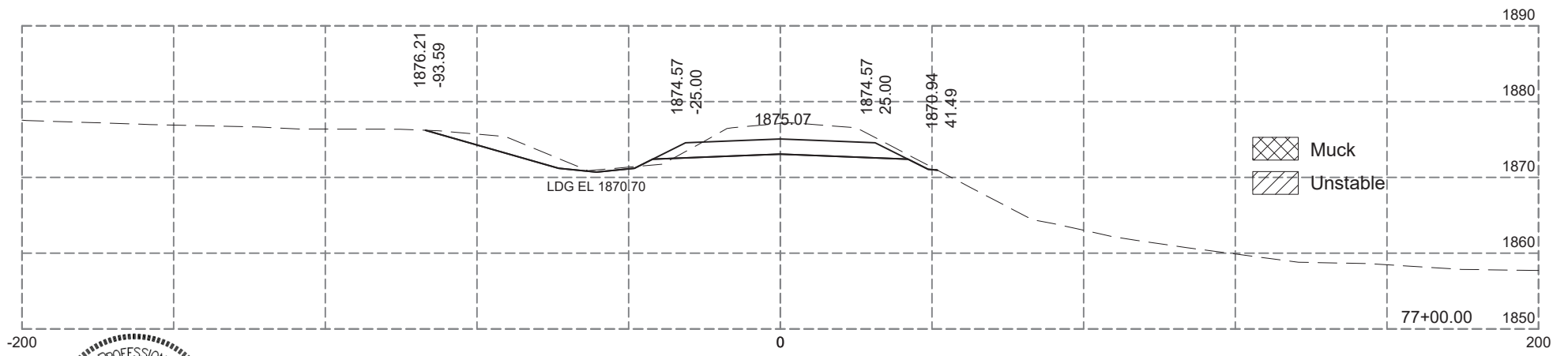
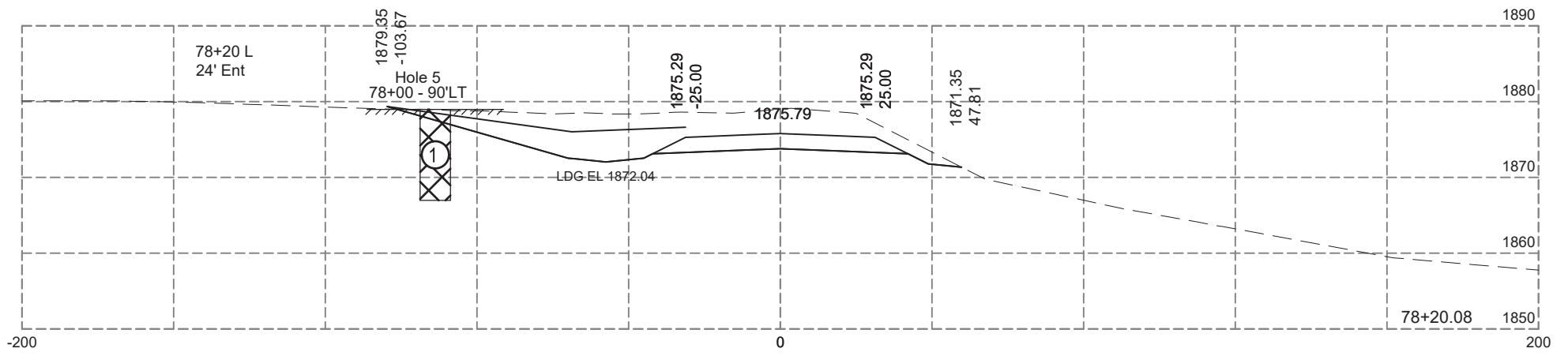
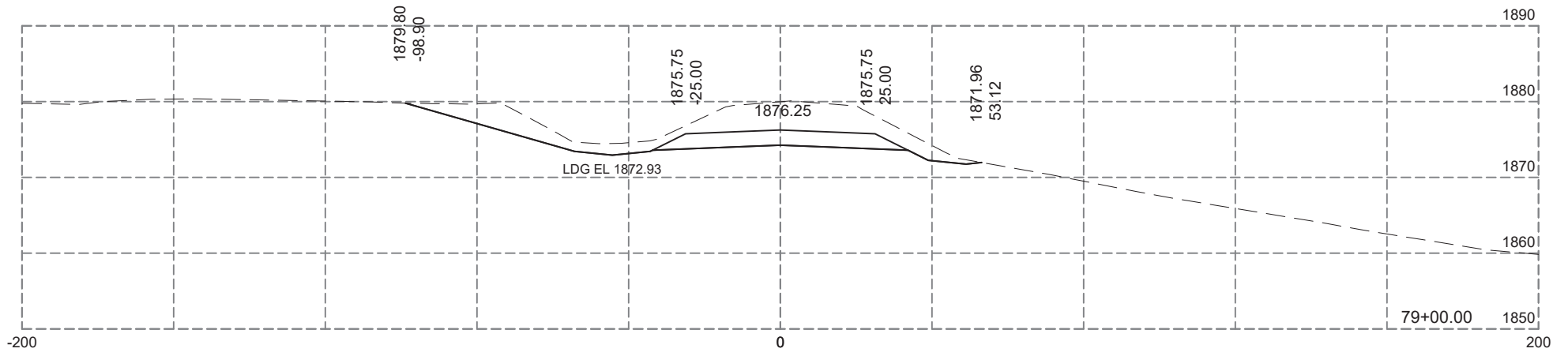
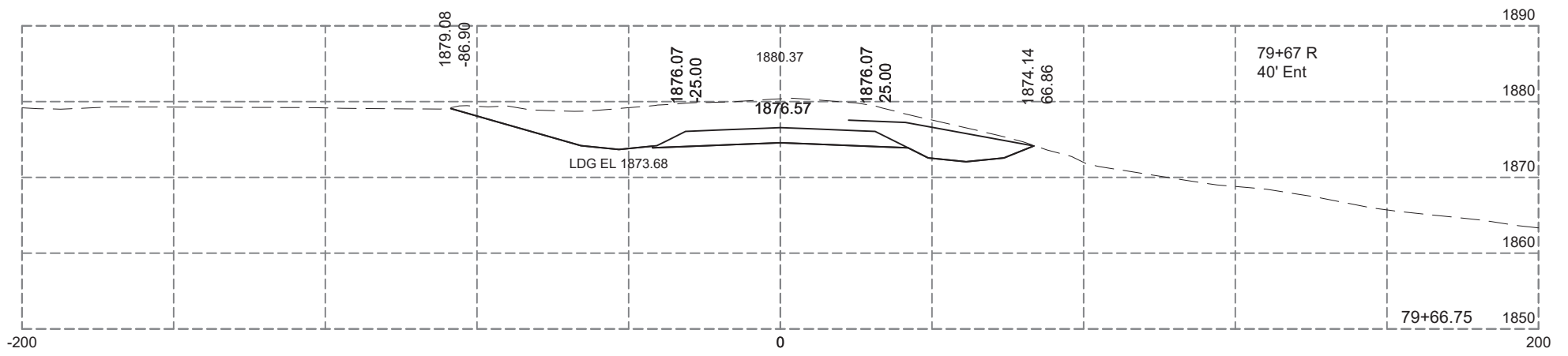
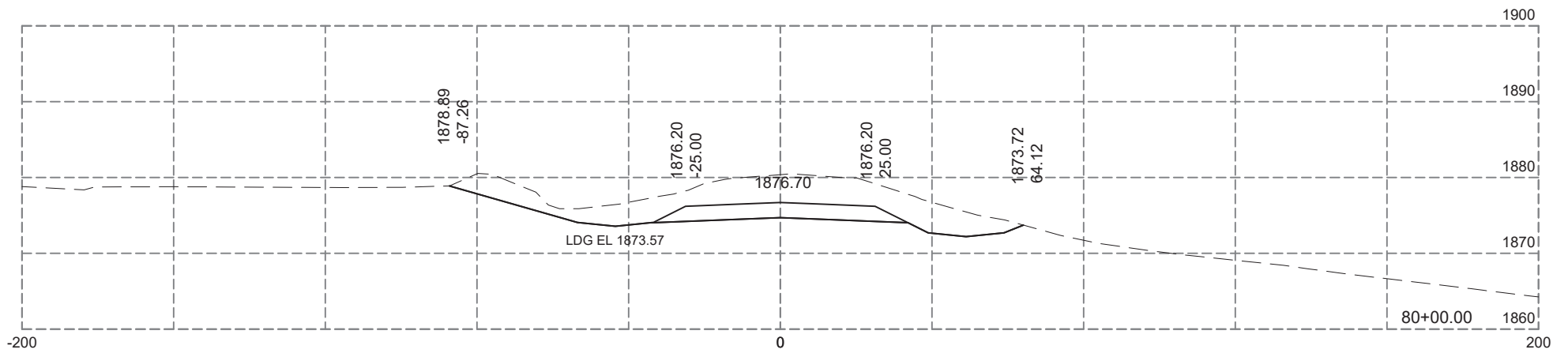
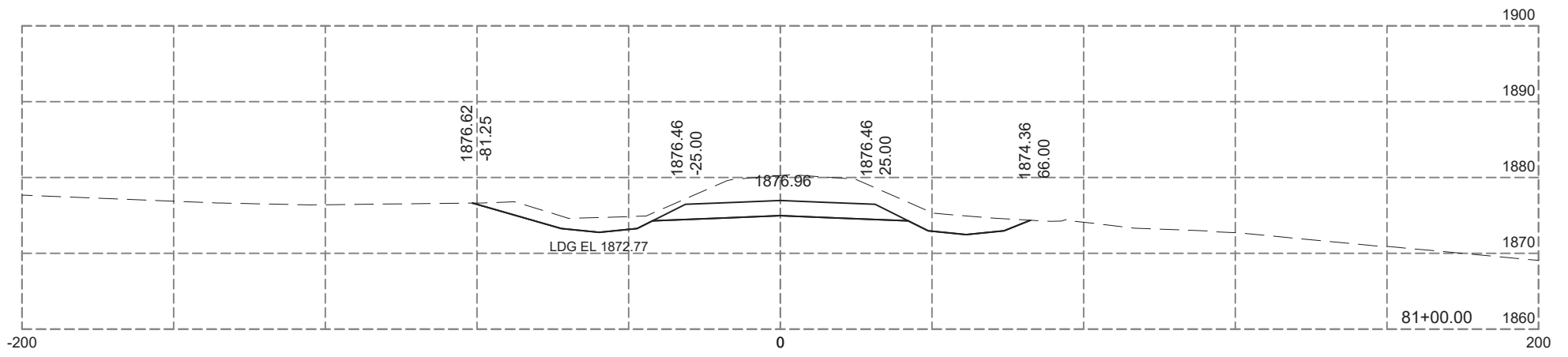

Plotting Date: 12-04-2024

STATE OF SOUTH DAKOTA	PROJECT P-PH-PT 0025(81)158	SHEET X85	TOTAL SHEETS X99
-----------------------	--------------------------------	--------------	---------------------

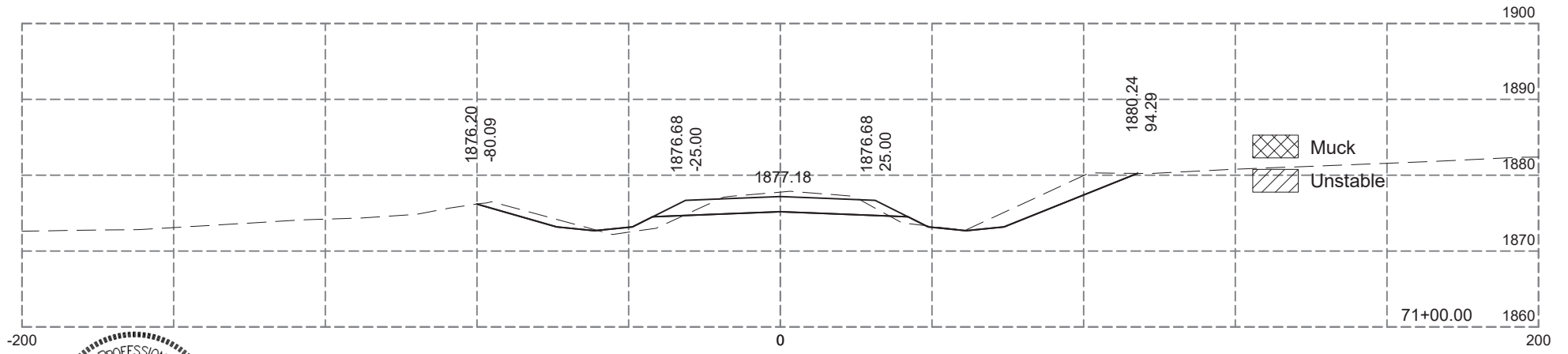
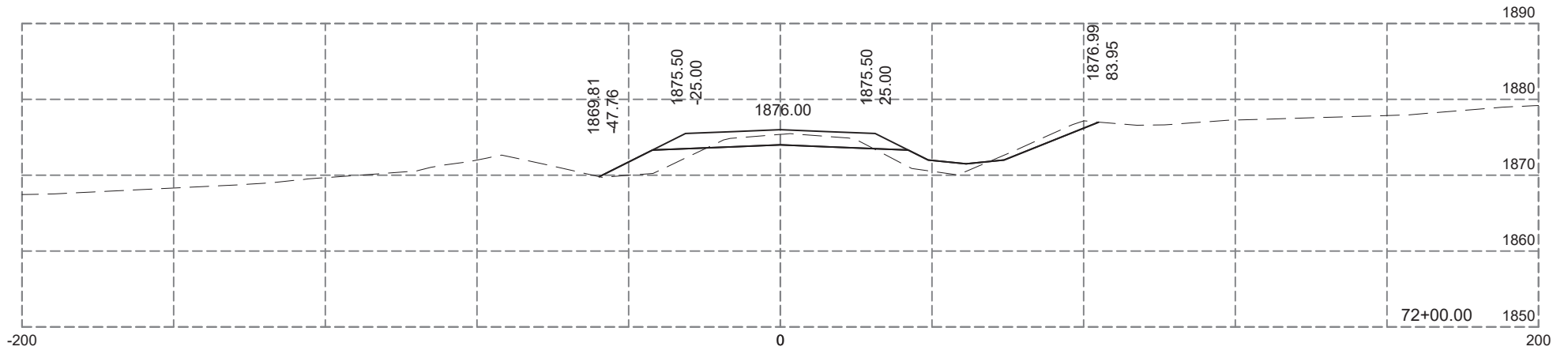
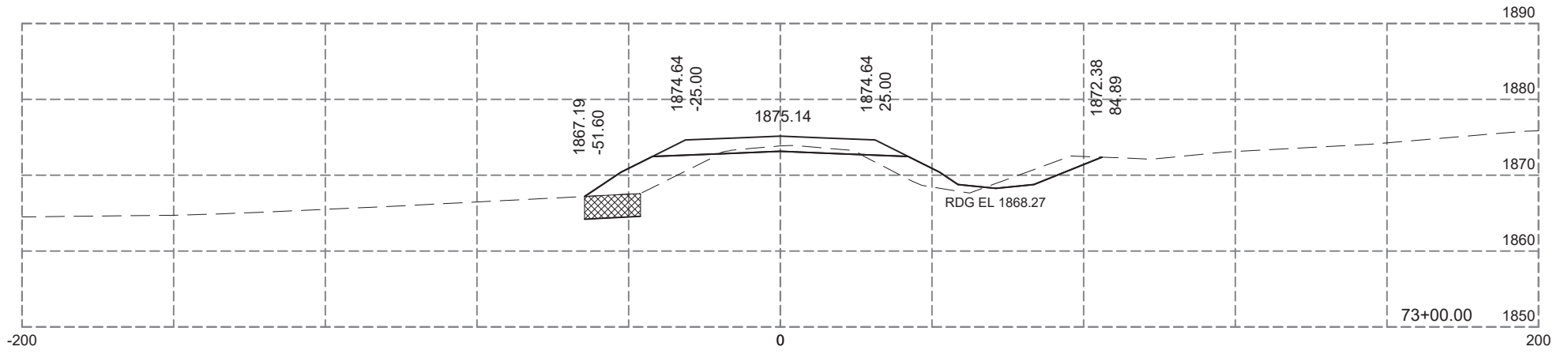
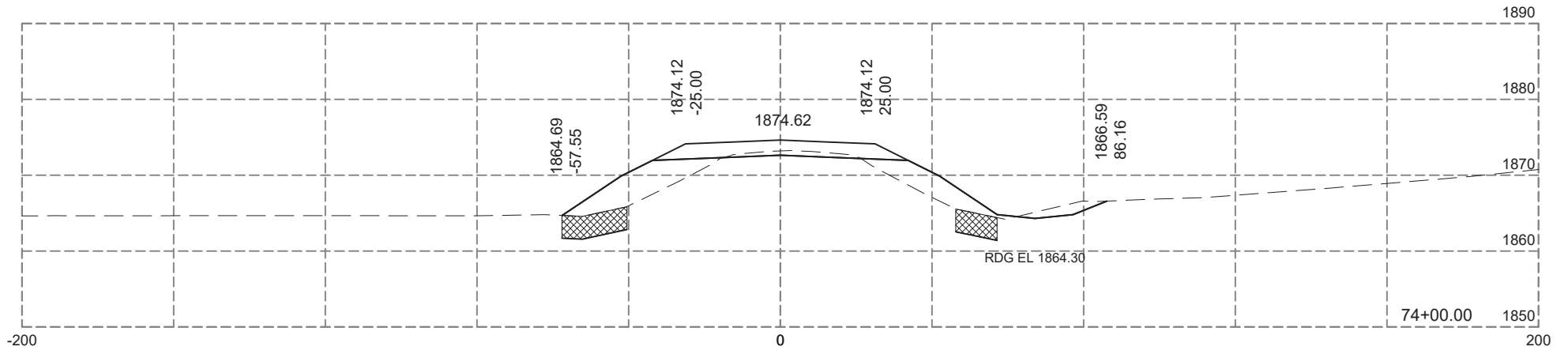
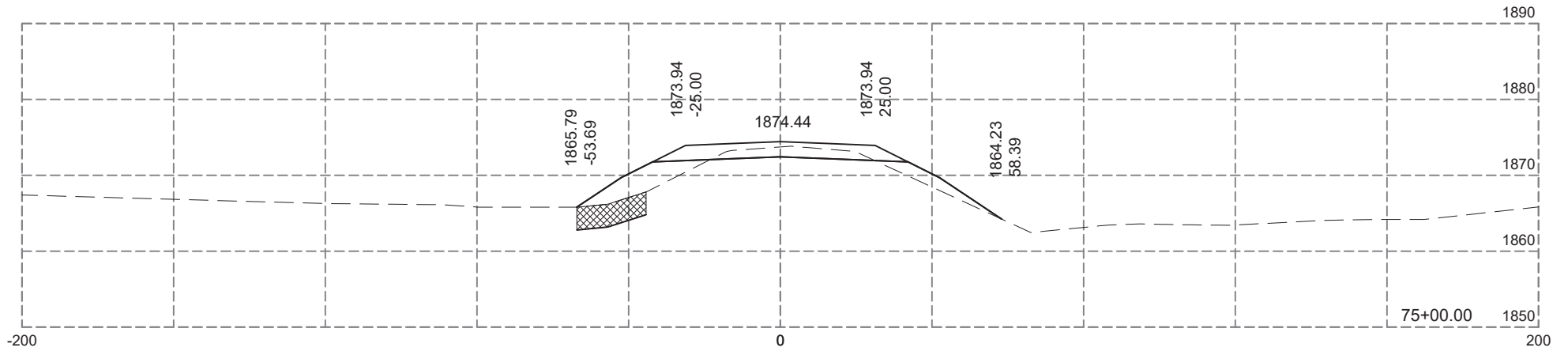
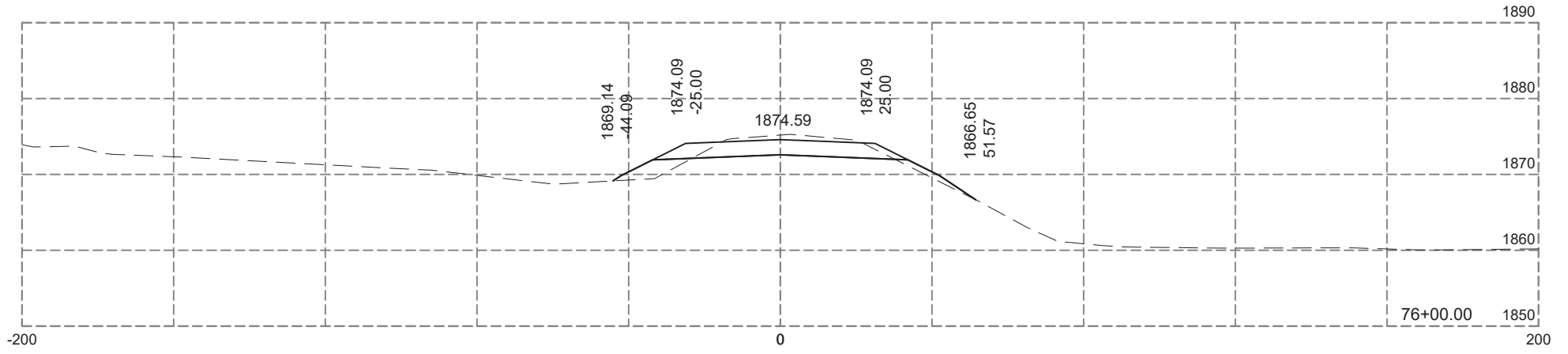

Plotting Date: 12-04-2024

STATE OF SOUTH DAKOTA	PROJECT	SHEET	TOTAL SHEETS
	P-PH-PT 0025(81)158	X86	X99

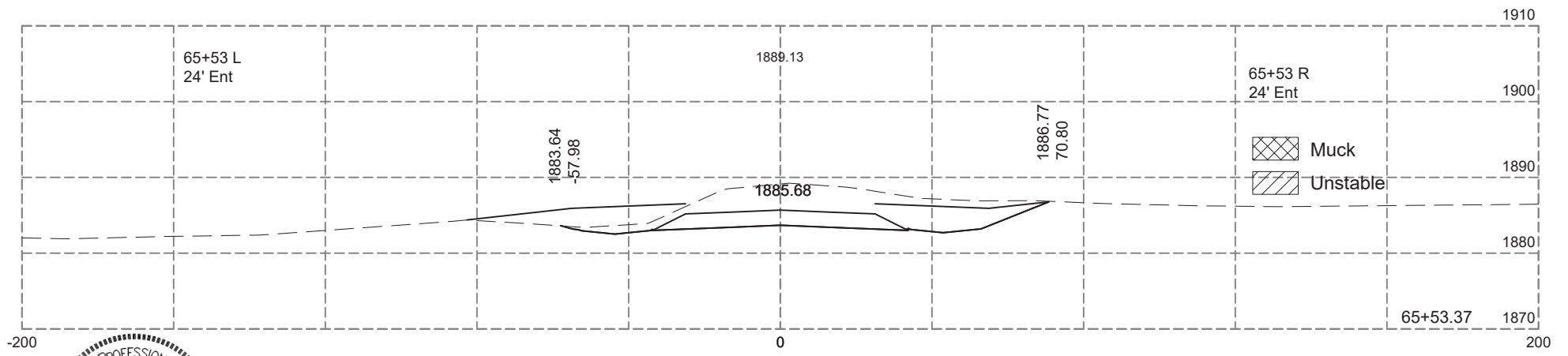
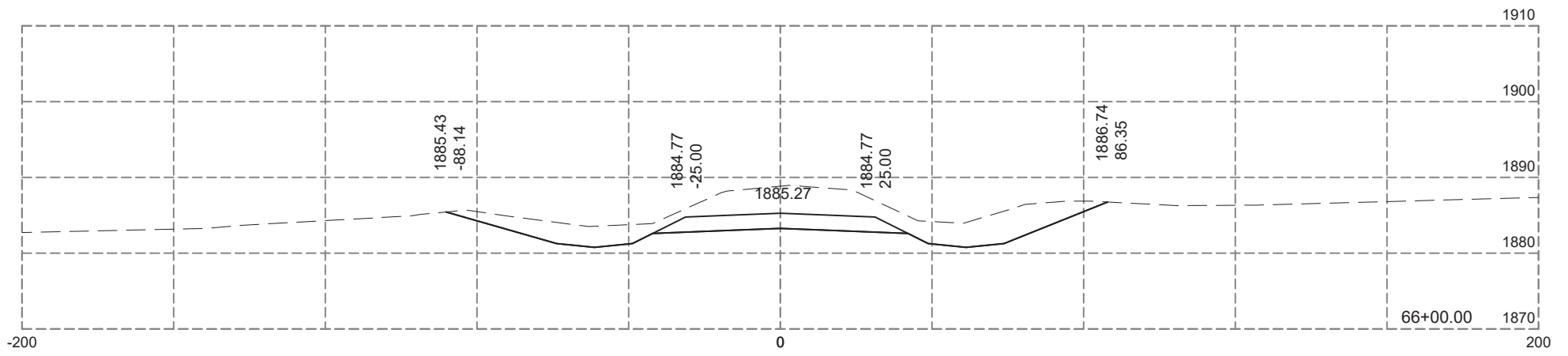
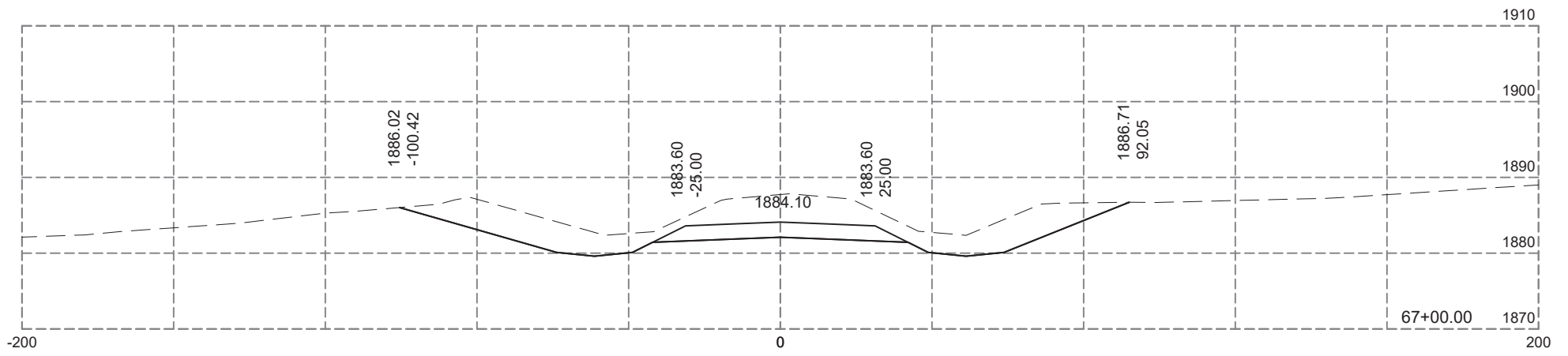
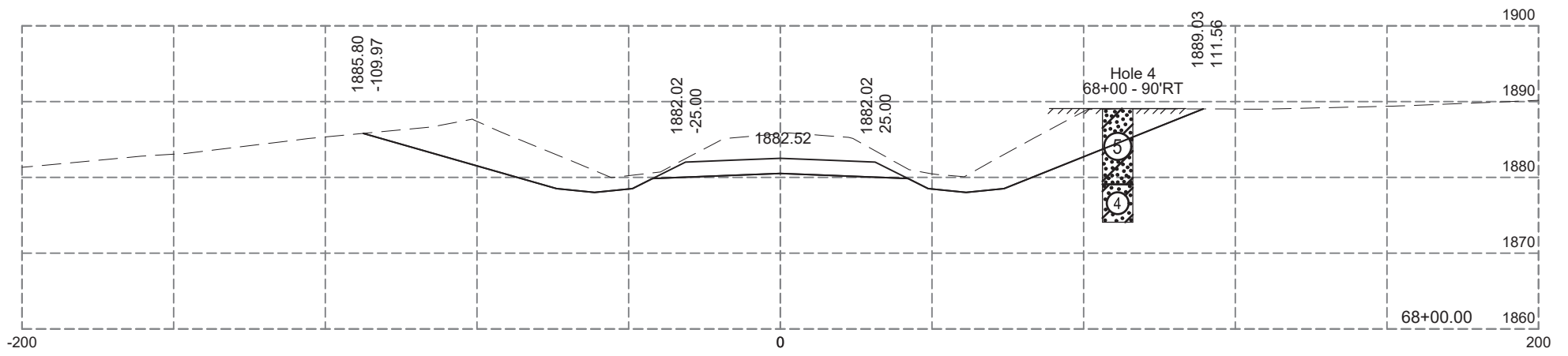
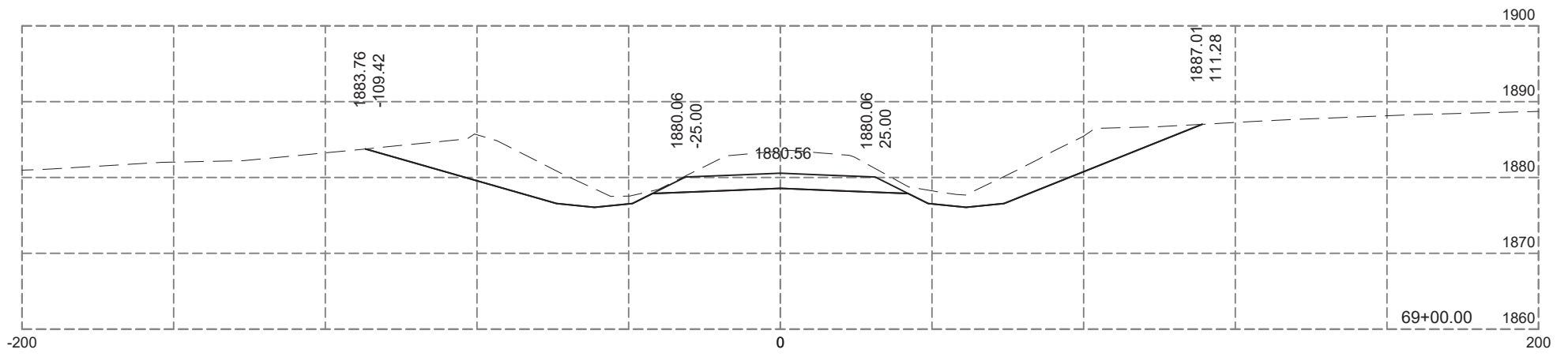
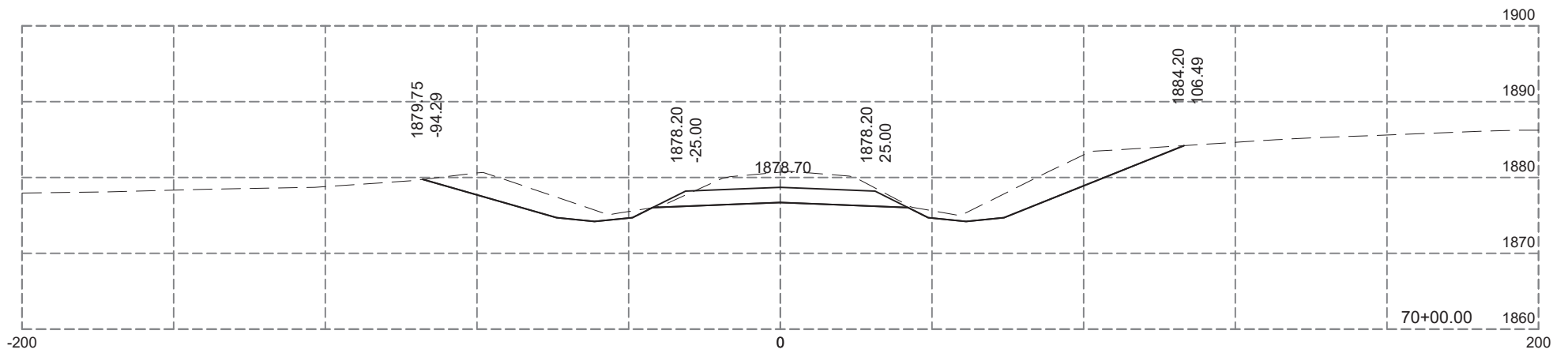

Plotting Date: 12-04-2024

STATE OF SOUTH DAKOTA	PROJECT P-PH-PT 0025(81)158	SHEET X87	TOTAL SHEETS X99
-----------------------	--------------------------------	--------------	---------------------

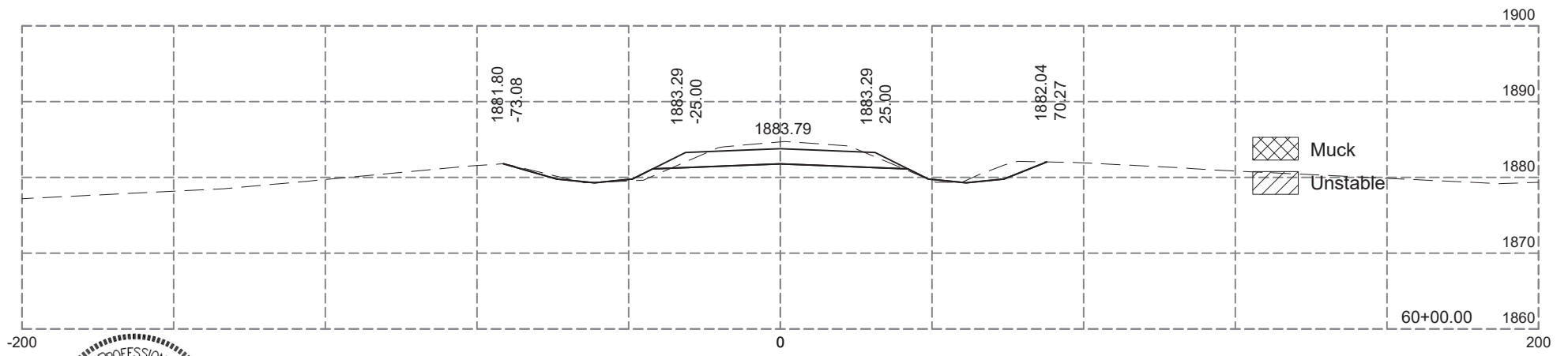
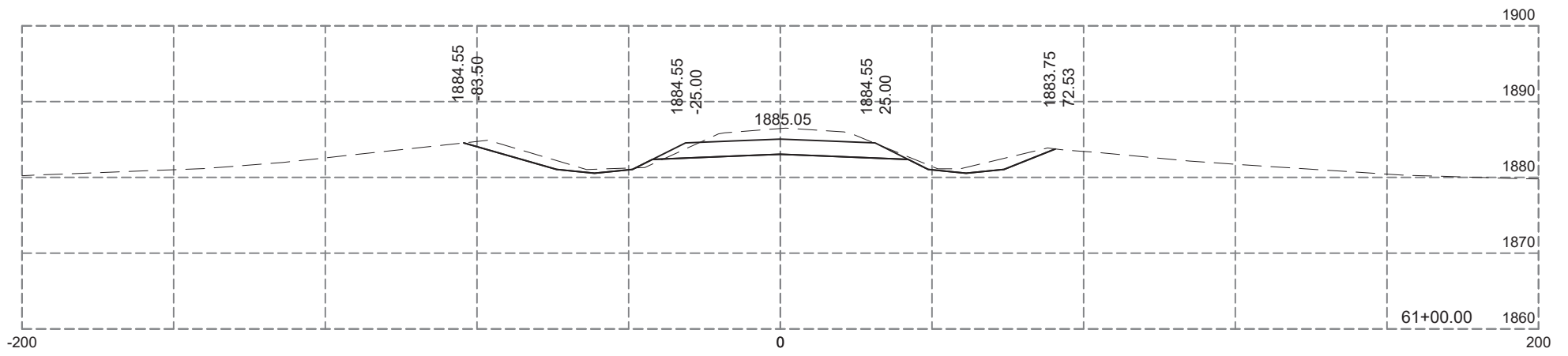
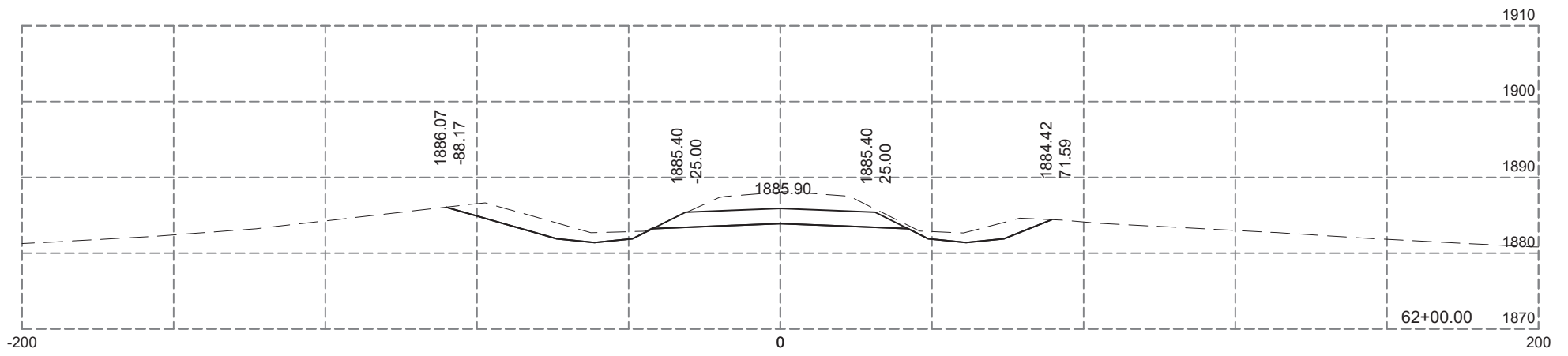
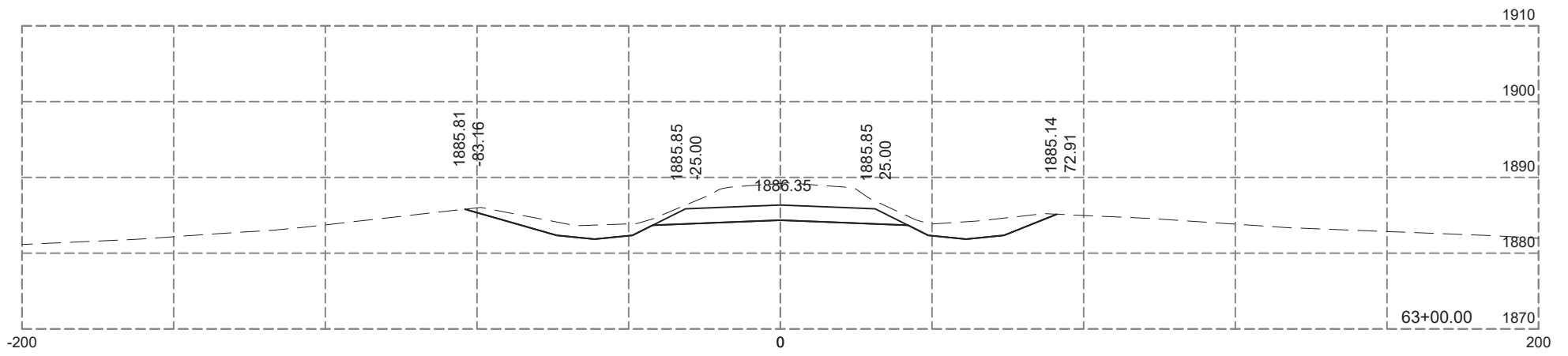
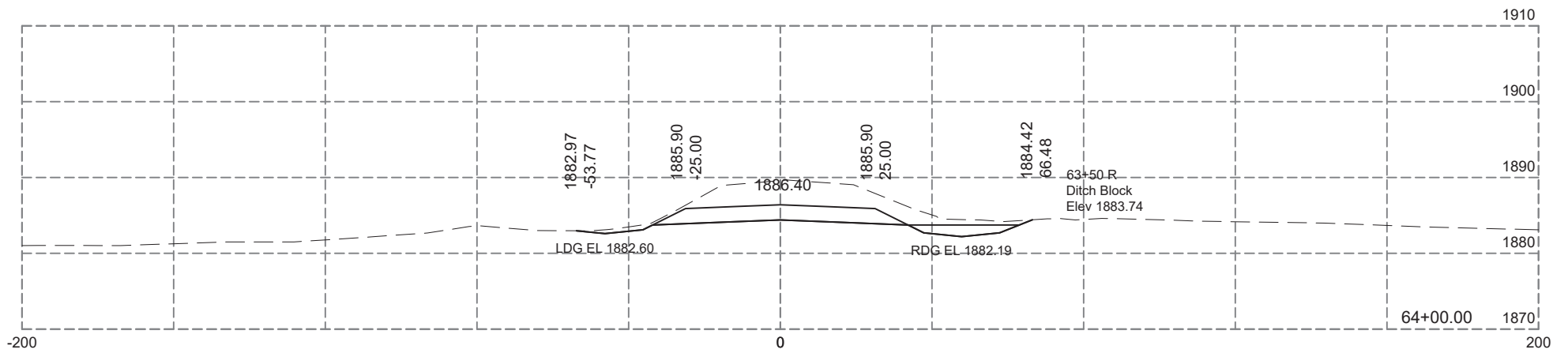
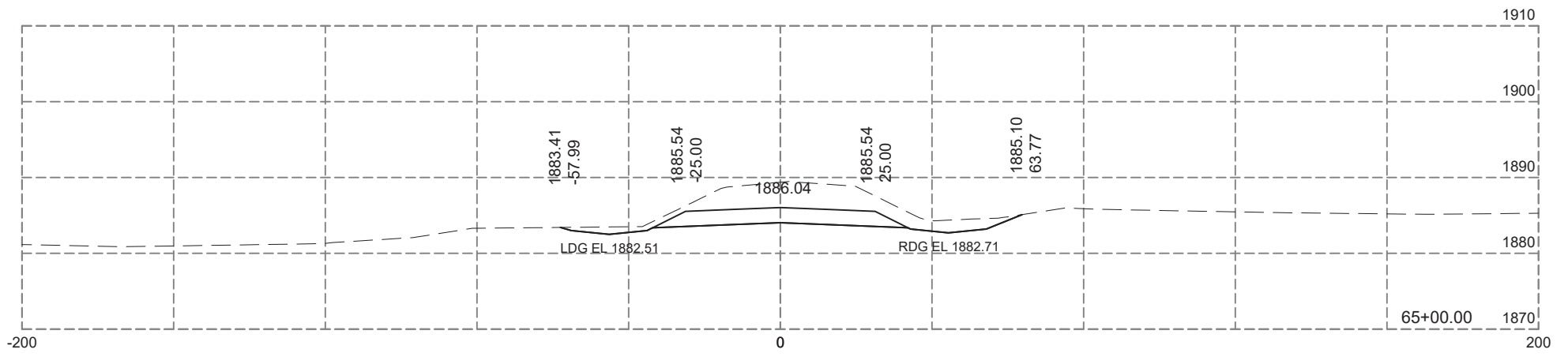

Plotting Date: 12-04-2024

STATE OF SOUTH DAKOTA	PROJECT P-PH-PT 0025(81)158	SHEET X88	TOTAL SHEETS X99
-----------------------	--------------------------------	--------------	---------------------



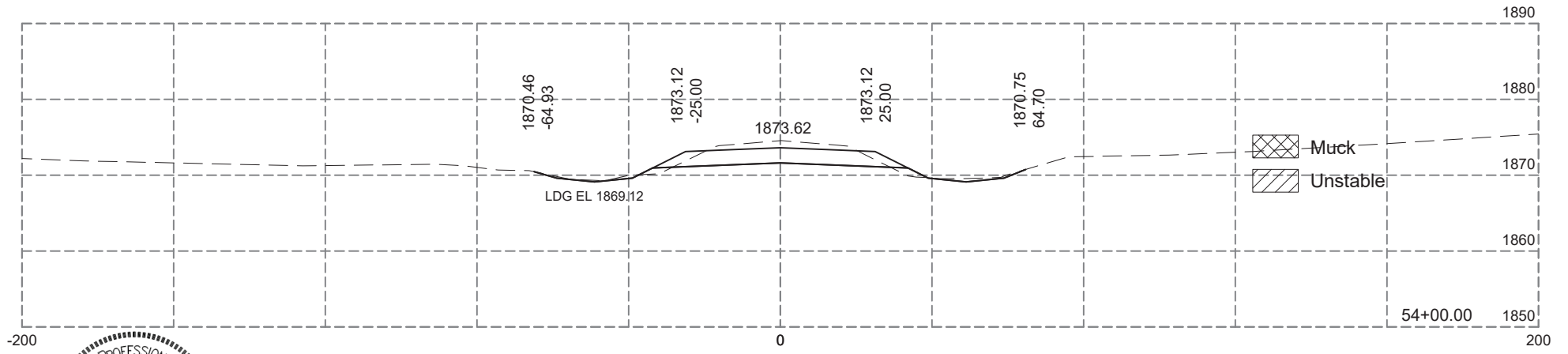
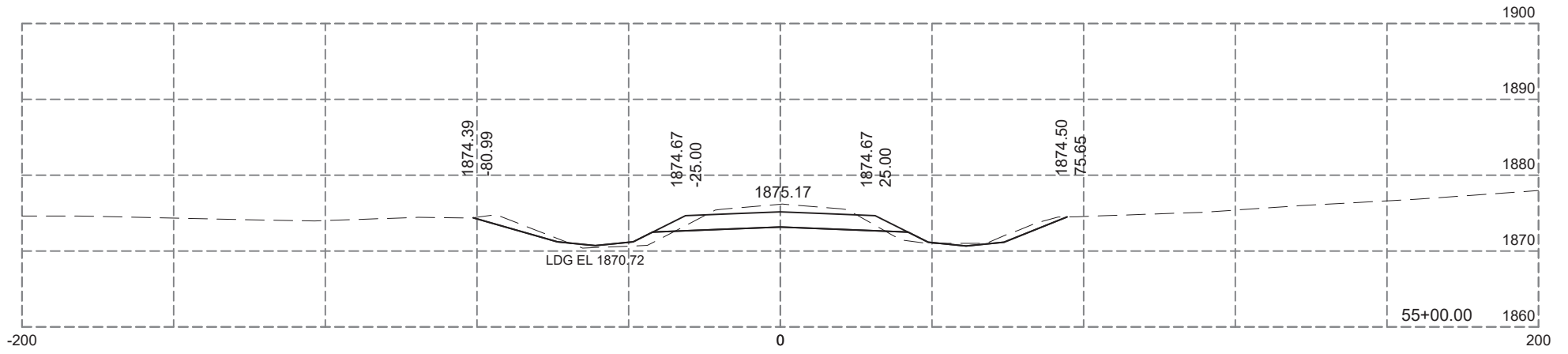
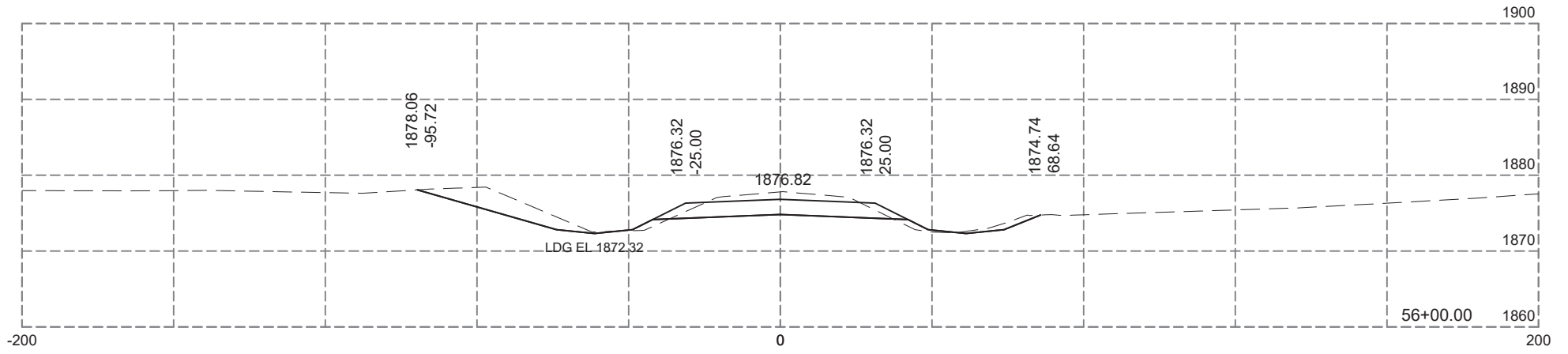
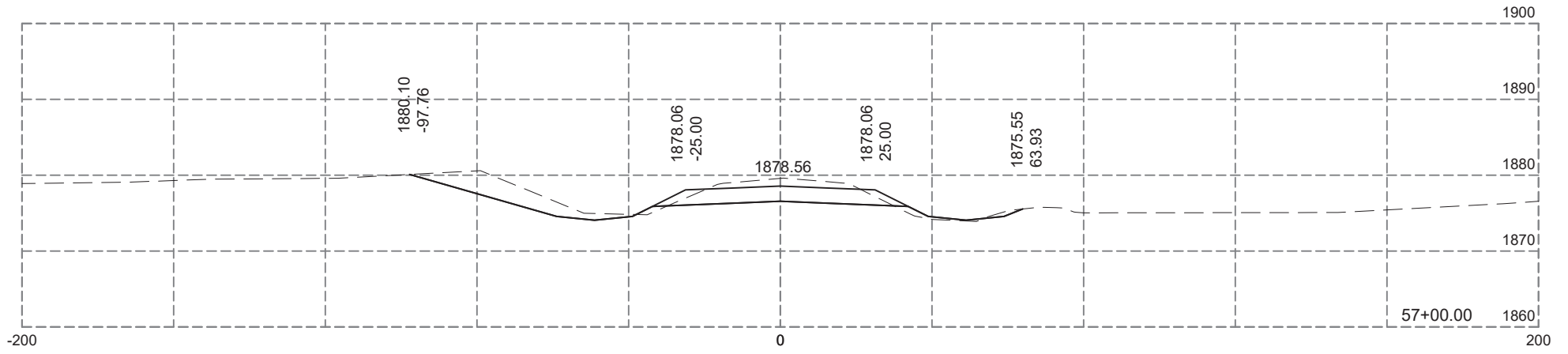
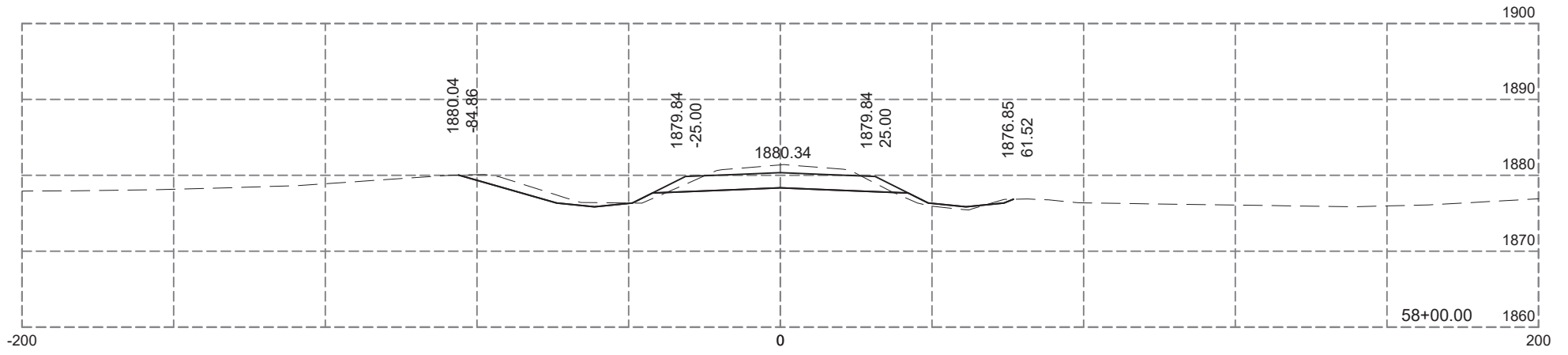
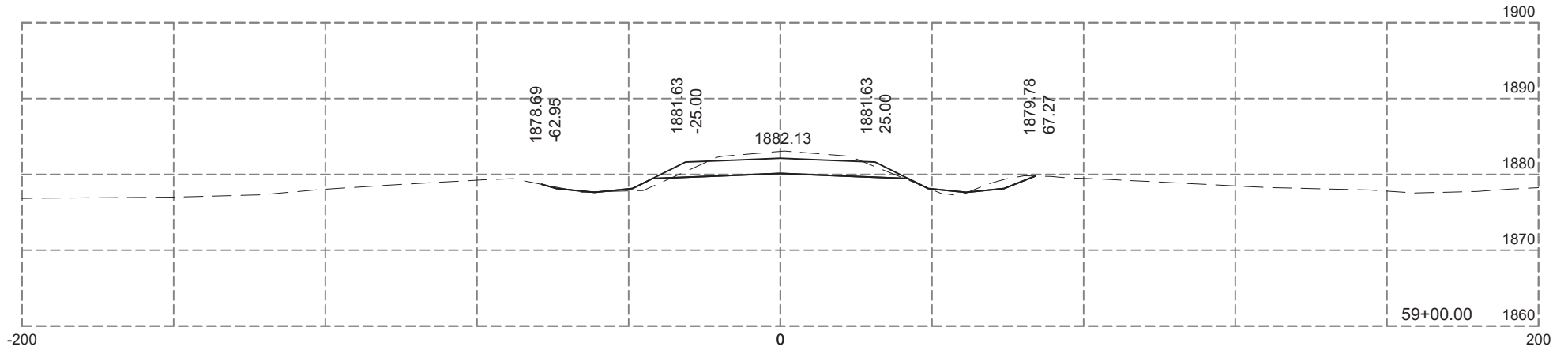

Plotting Date: 12-04-2024

STATE OF SOUTH DAKOTA	PROJECT	SHEET	TOTAL SHEETS
	P-PH-PT 0025(81)158	X89	X99

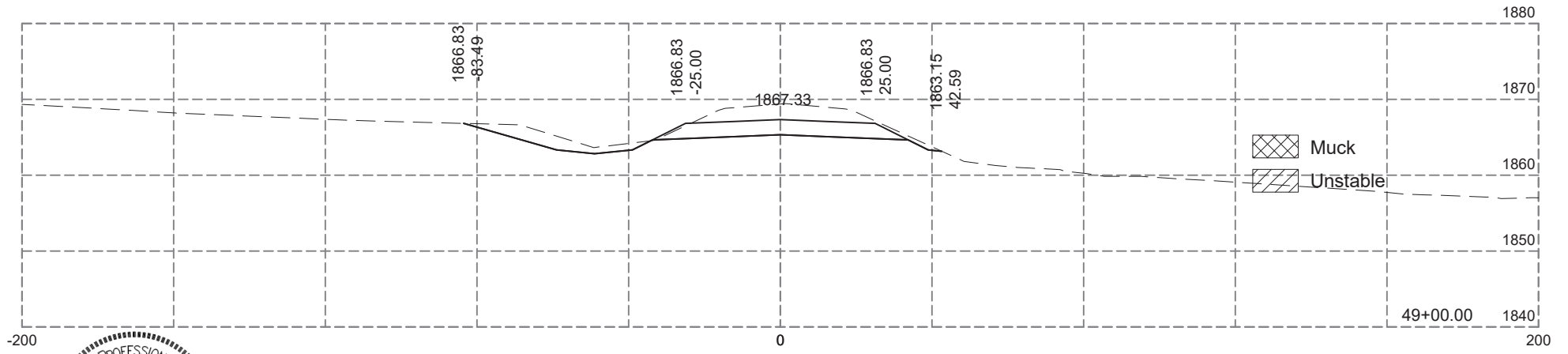
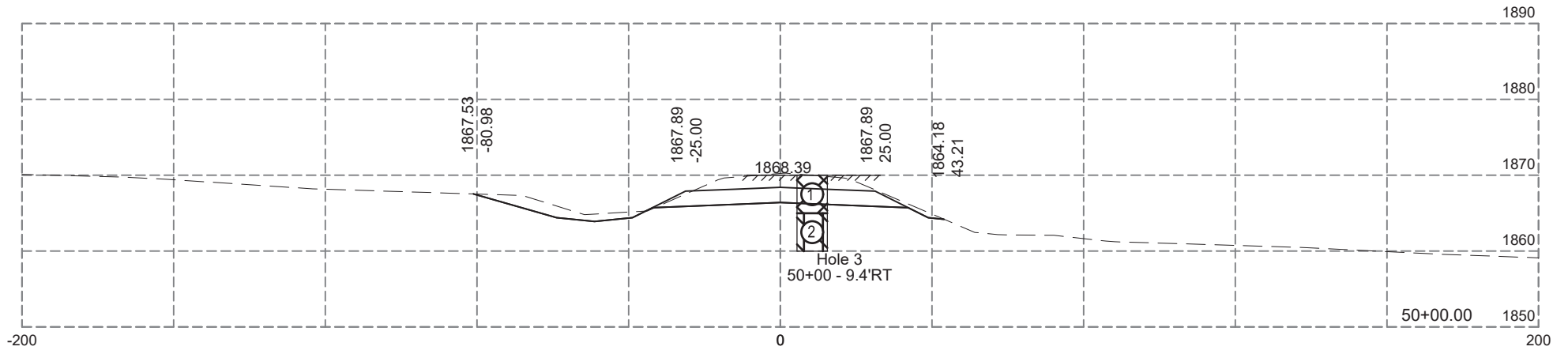
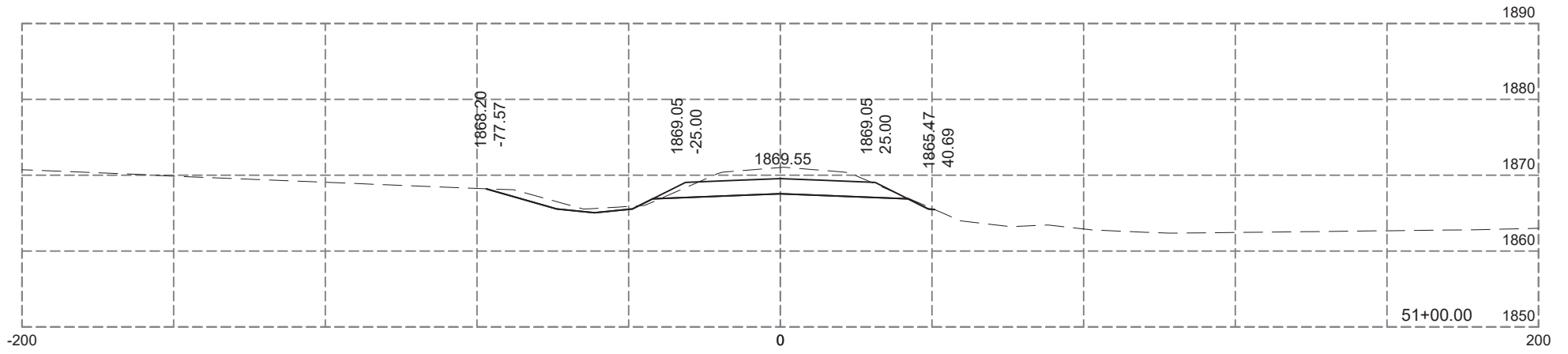
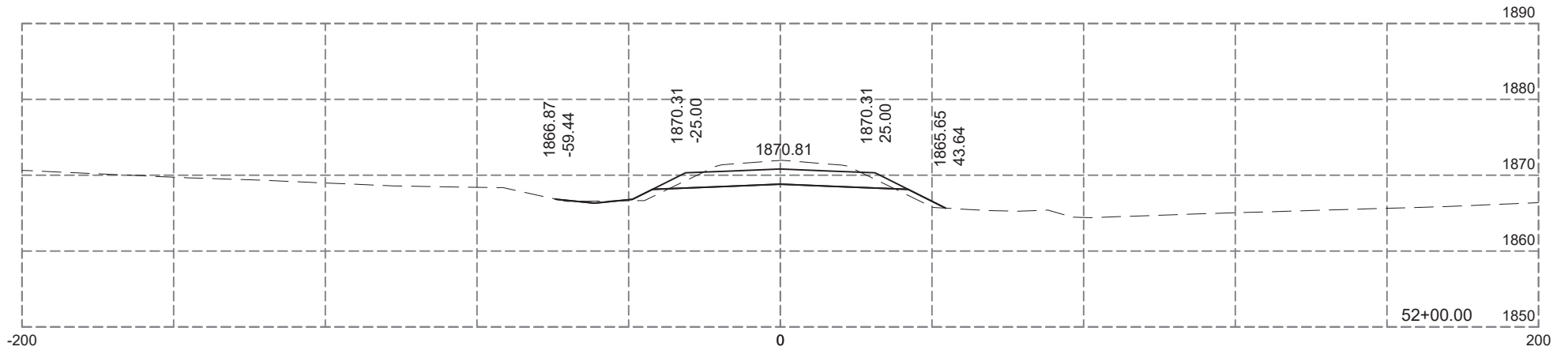
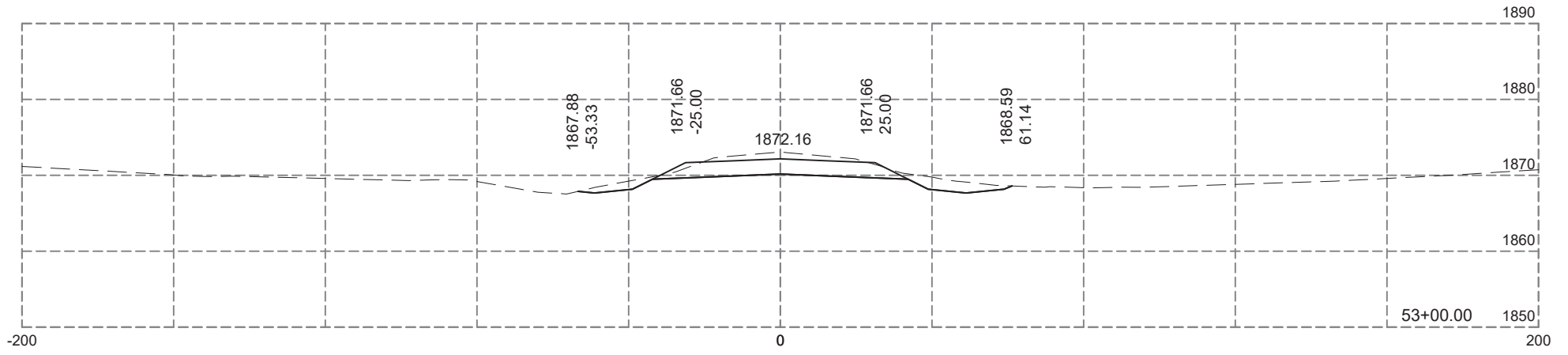
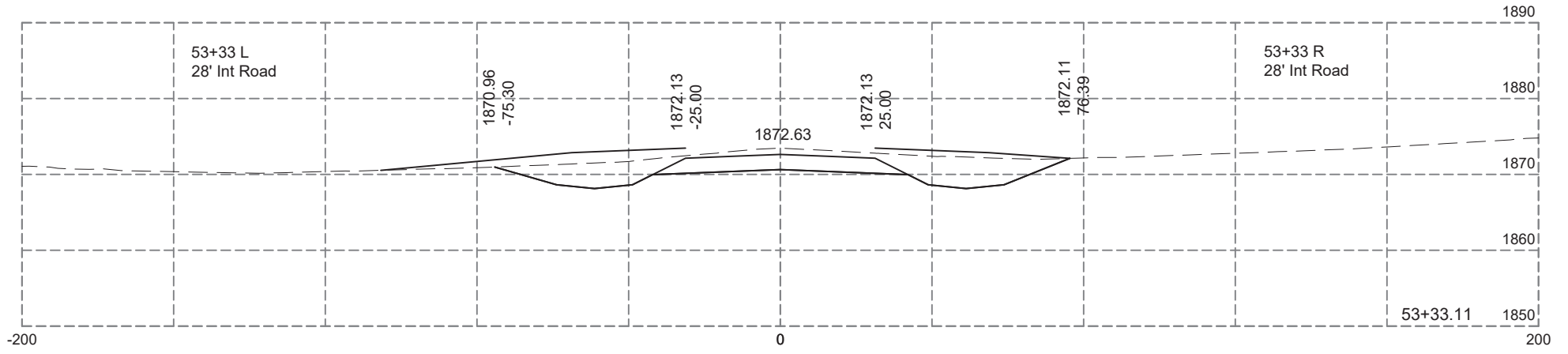

Plotting Date: 12-04-2024

STATE OF SOUTH DAKOTA	PROJECT P-PH-PT 0025(81)158	SHEET X90	TOTAL SHEETS X99
-----------------------	--------------------------------	--------------	---------------------

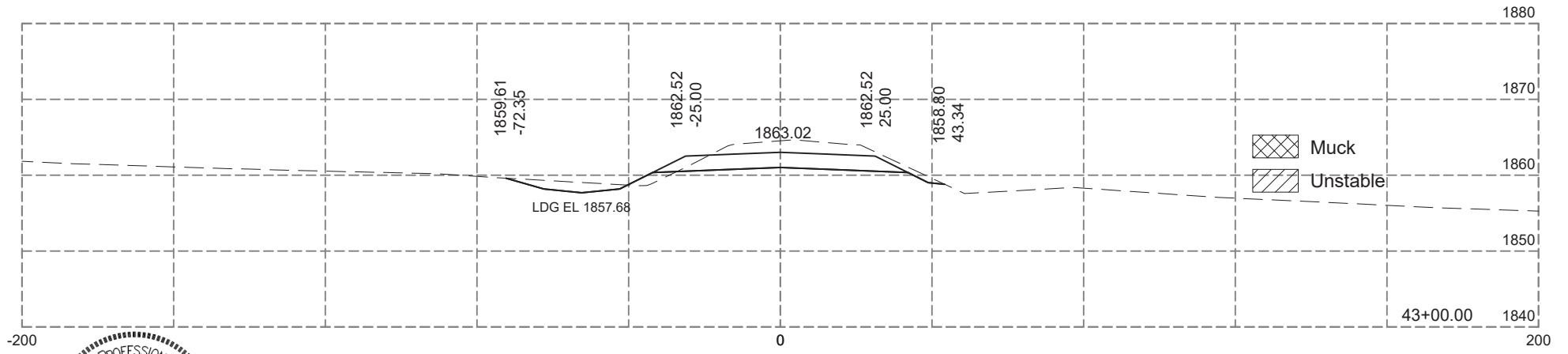
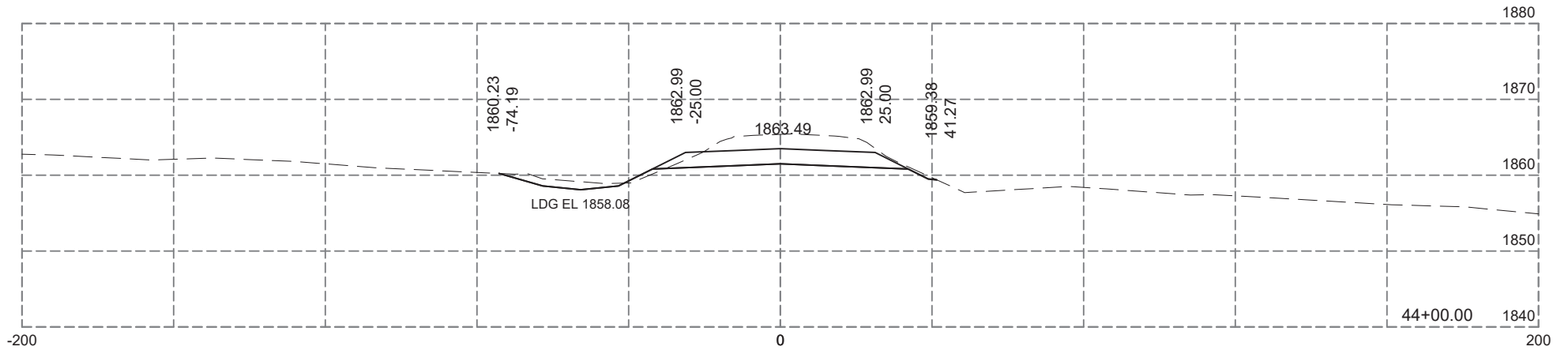
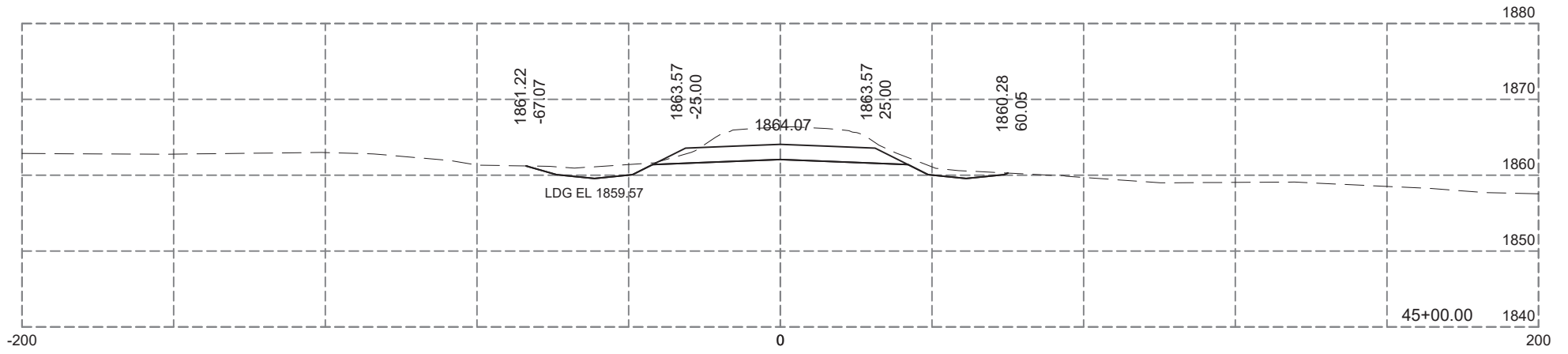
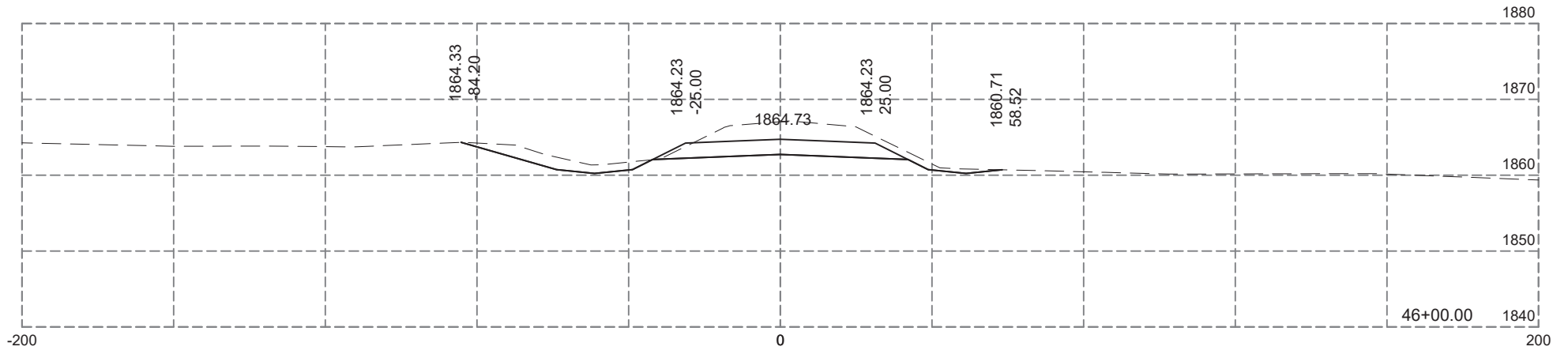
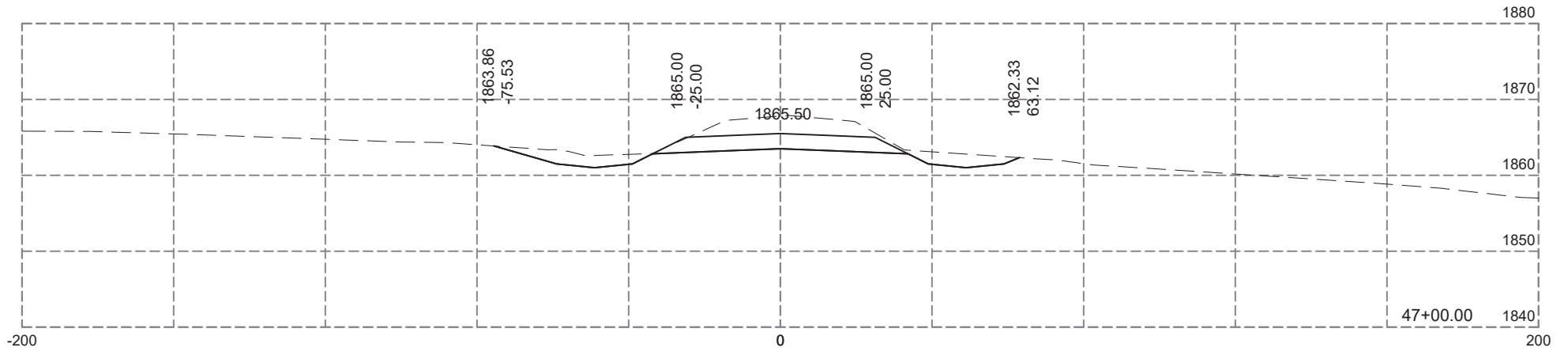
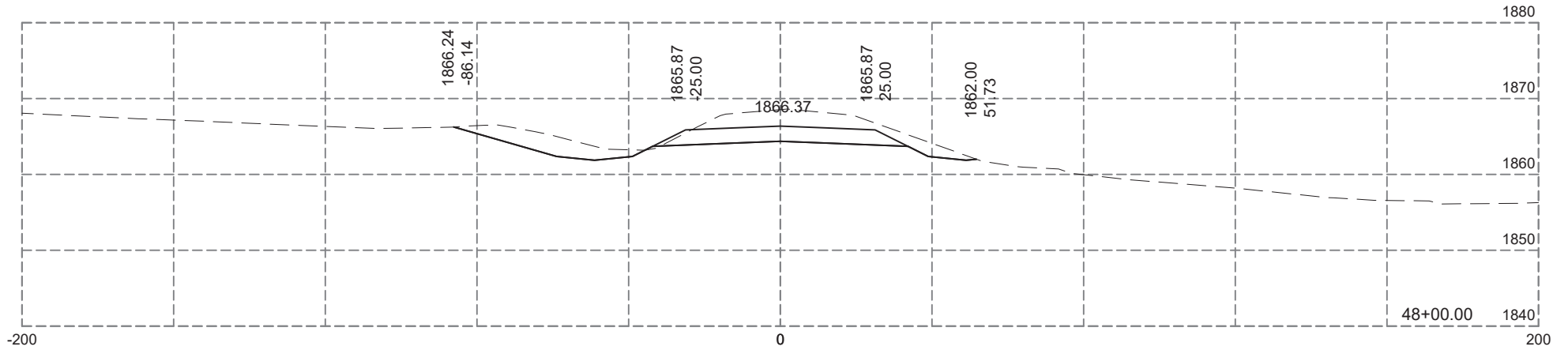

Plotting Date: 12-04-2024

STATE OF SOUTH DAKOTA	PROJECT	SHEET	TOTAL SHEETS
	P-PH-PT 0025(81)158	X91	X99

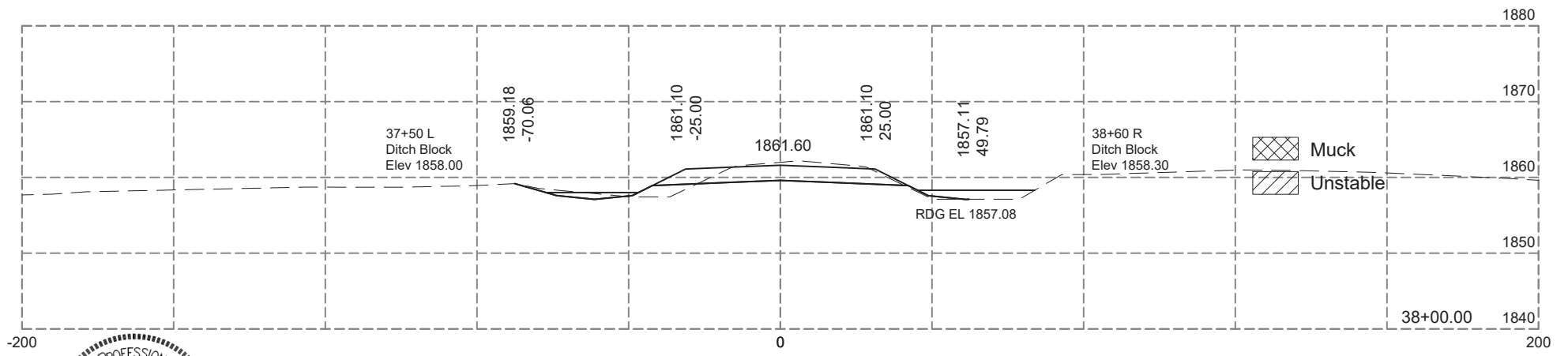
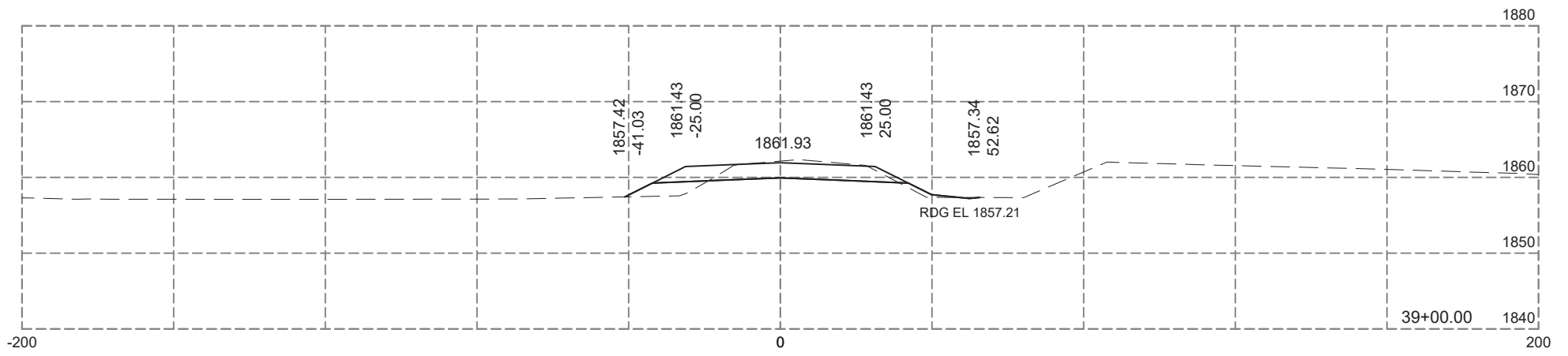
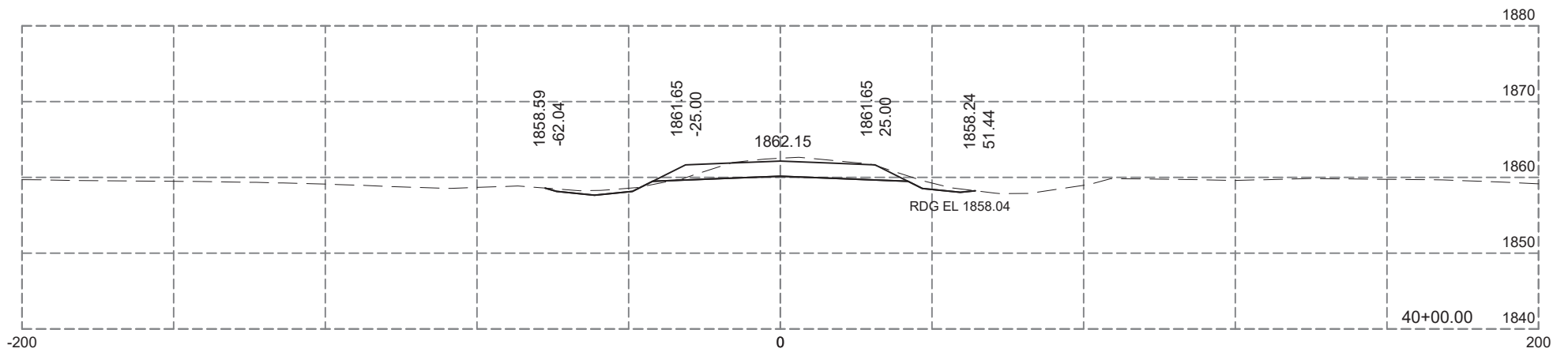
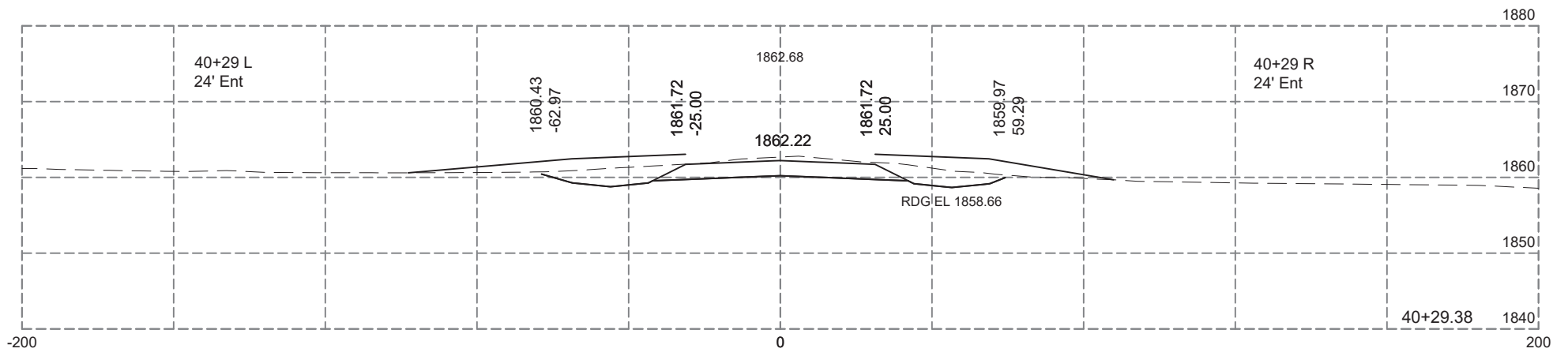
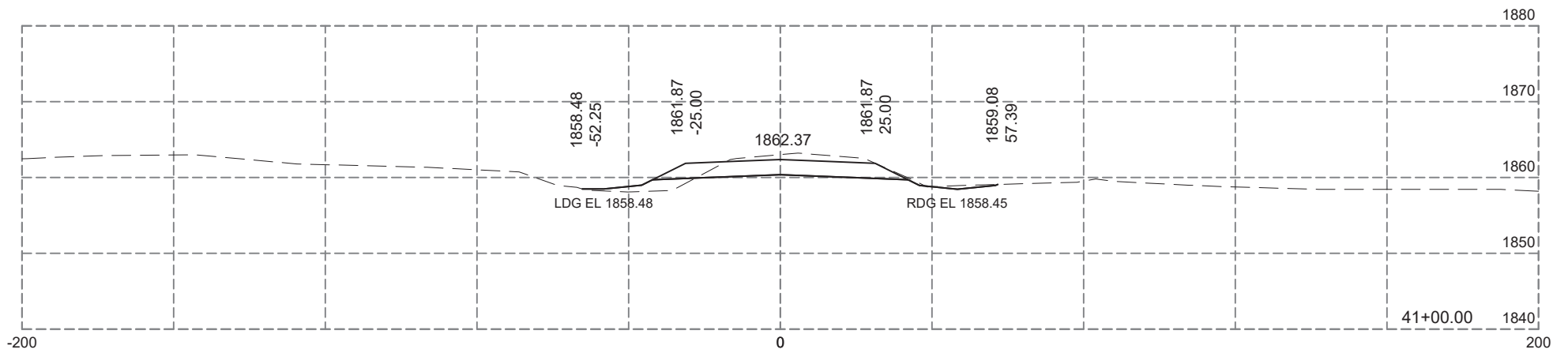
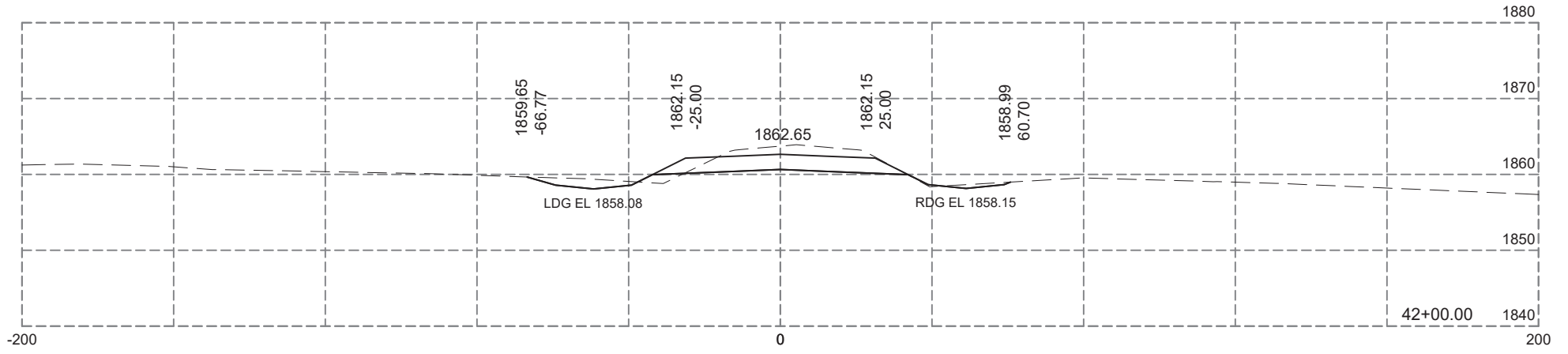

Plotting Date: 12-04-2024

STATE OF SOUTH DAKOTA	PROJECT P-PH-PT 0025(81)158	SHEET X92	TOTAL SHEETS X99
-----------------------	--------------------------------	--------------	---------------------

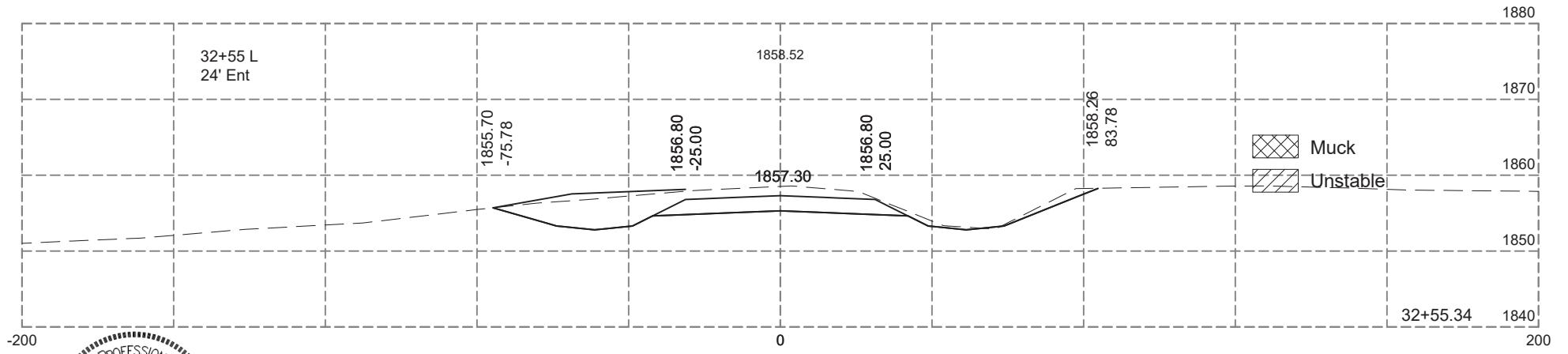
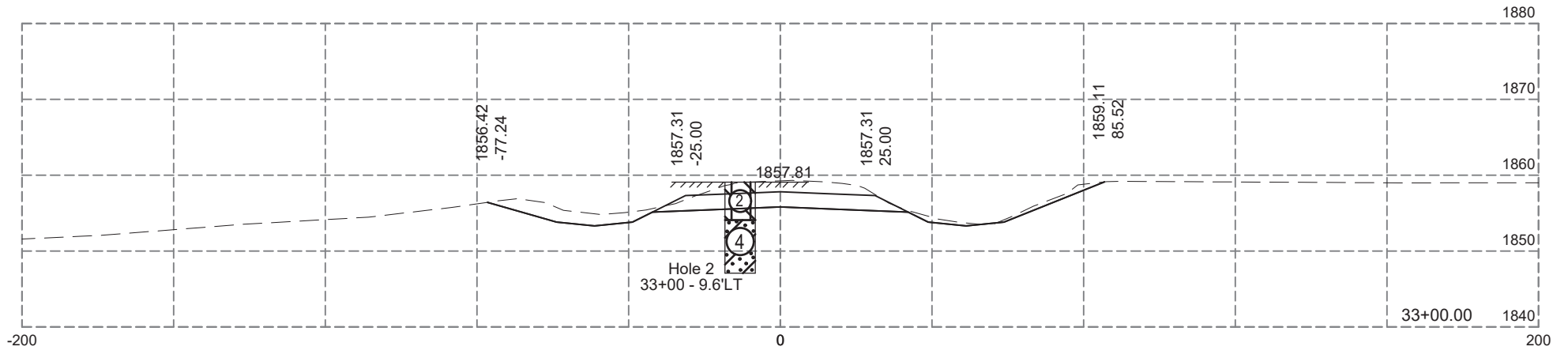
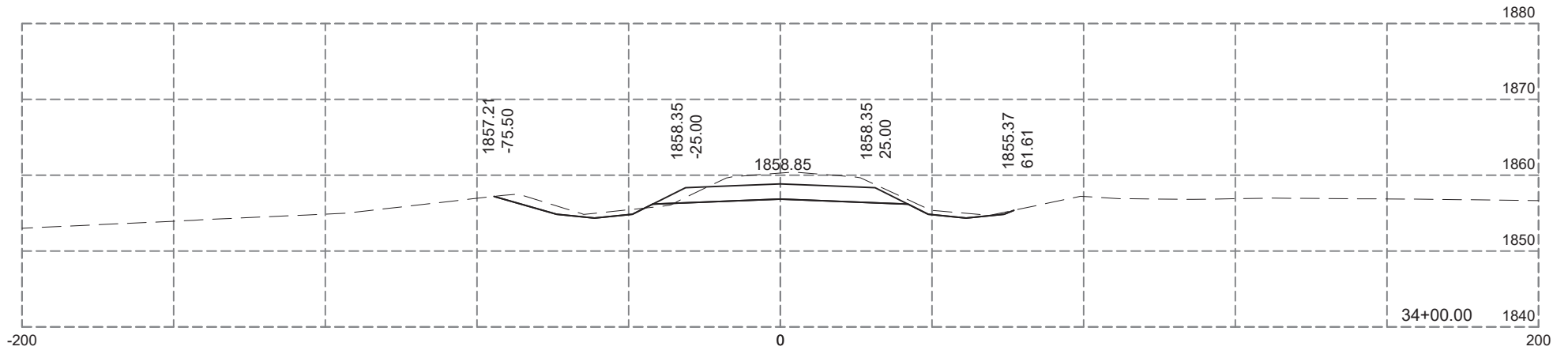
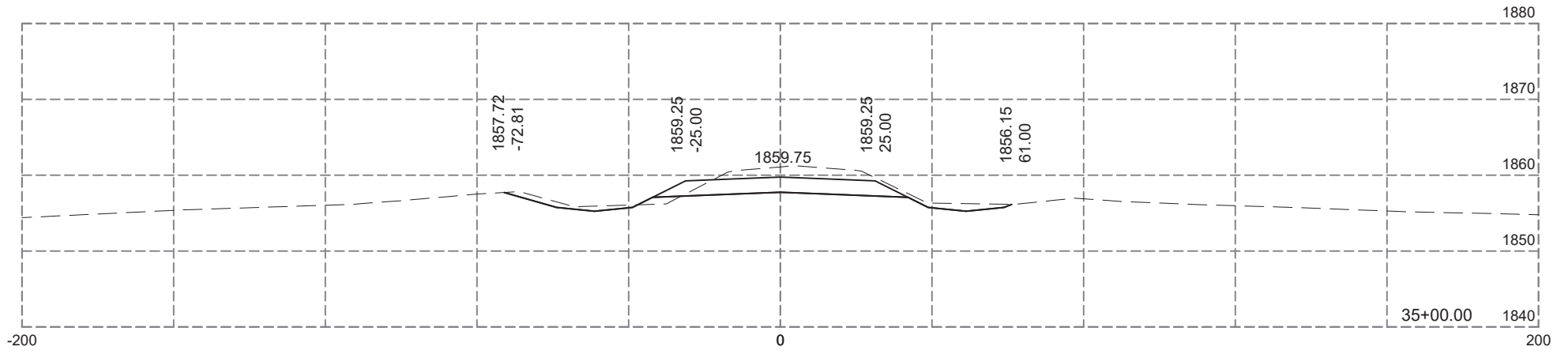
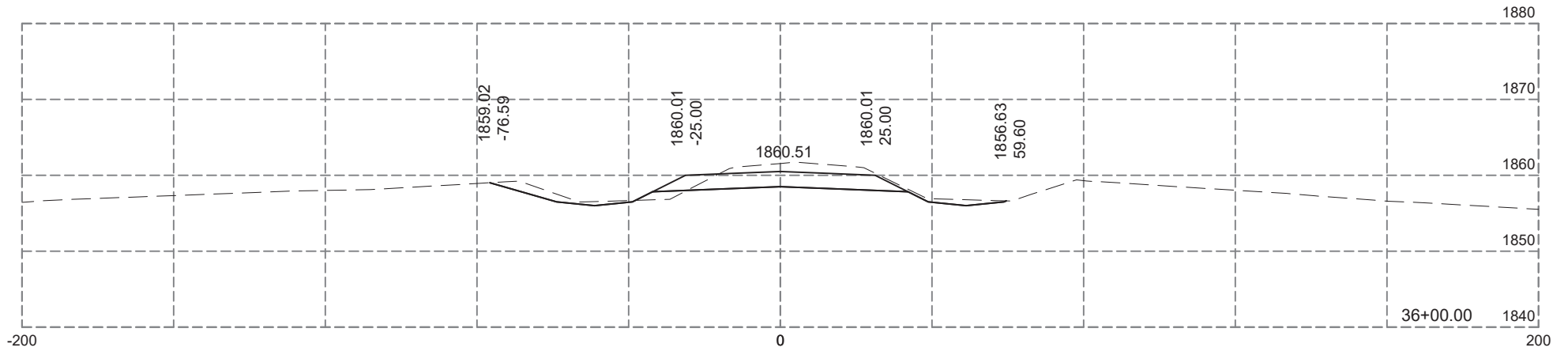
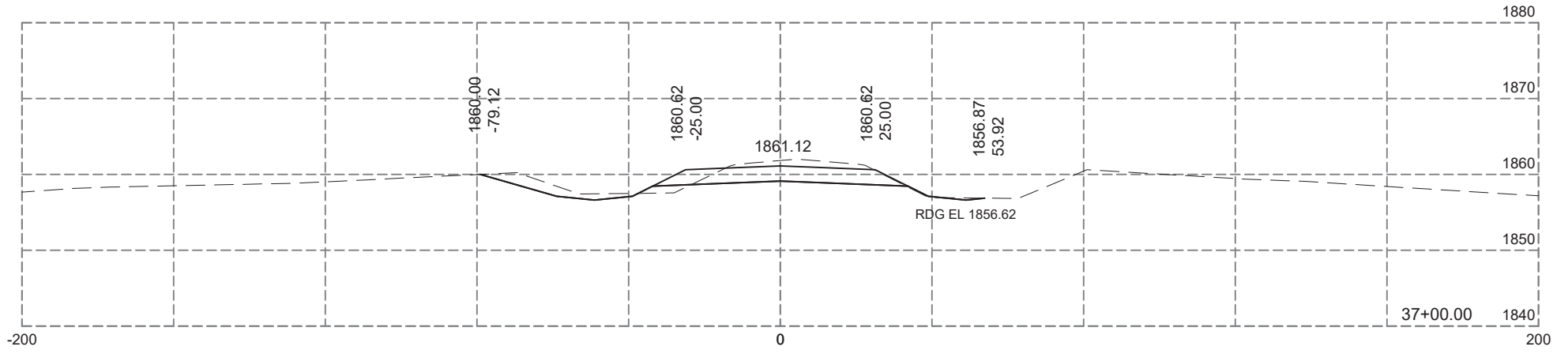

Plotting Date: 12-04-2024

STATE OF SOUTH DAKOTA	PROJECT P-PH-PT 0025(81)158	SHEET X93	TOTAL SHEETS X99
-----------------------	--------------------------------	--------------	---------------------

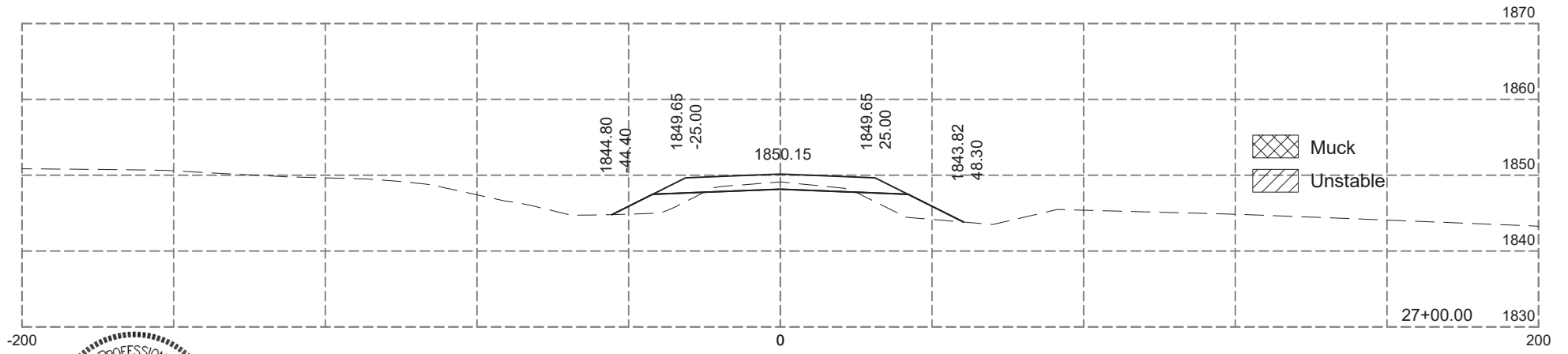
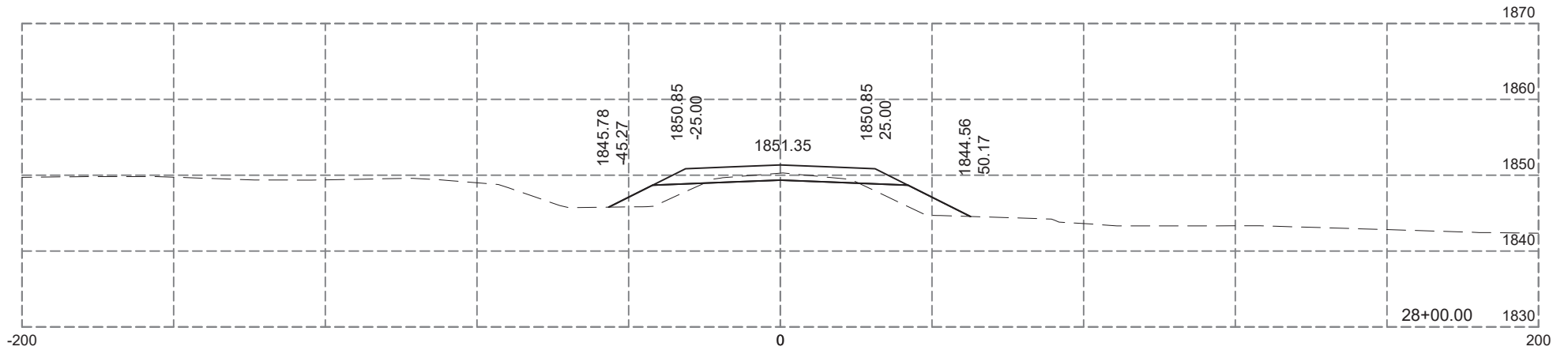
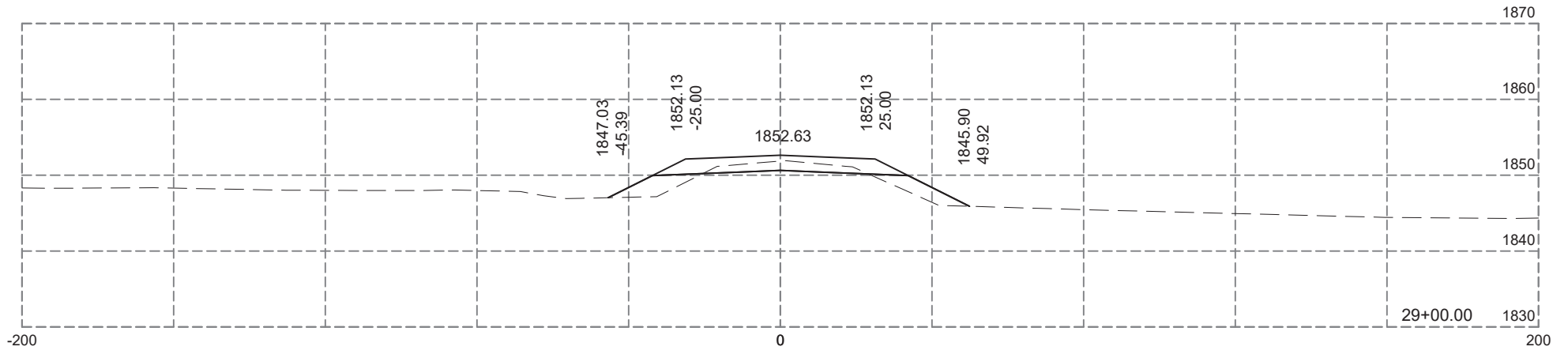
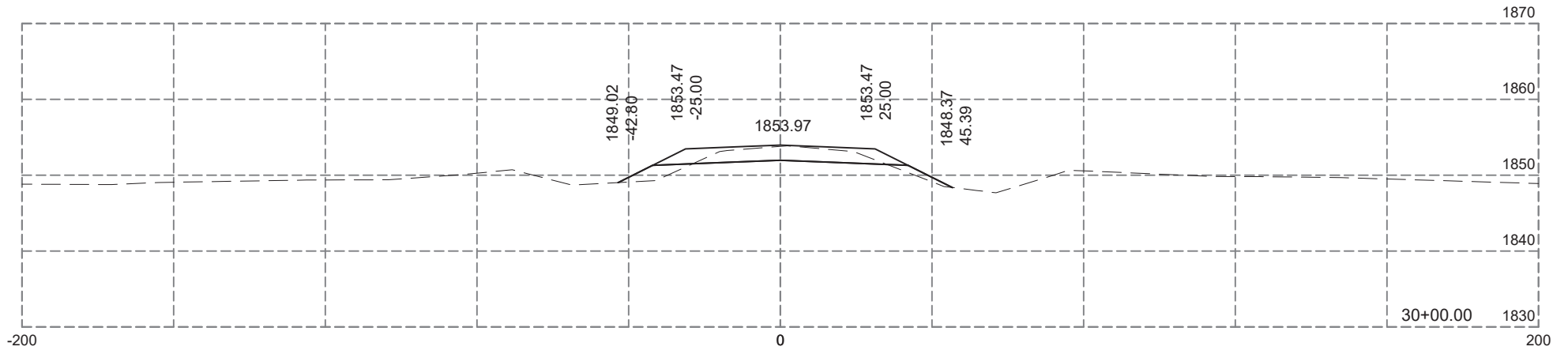
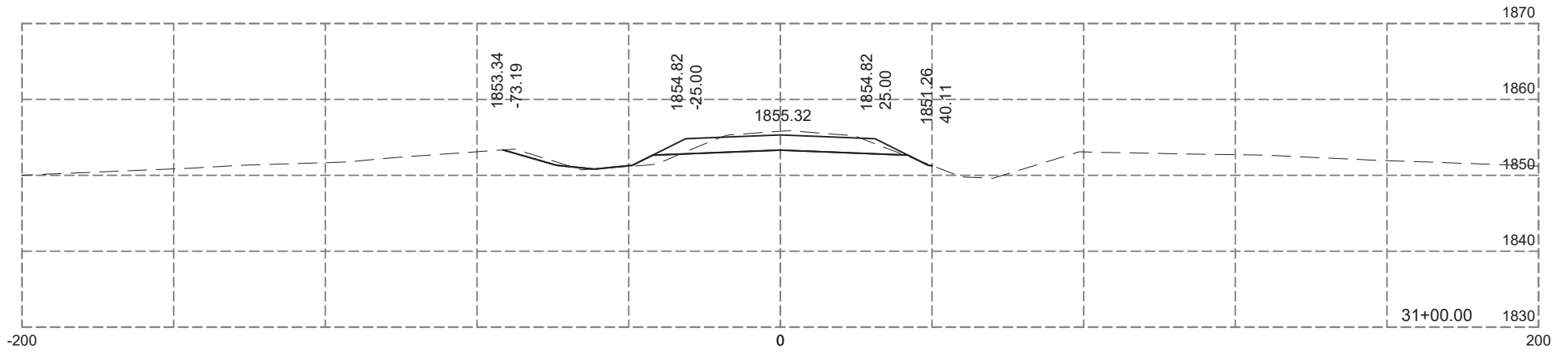
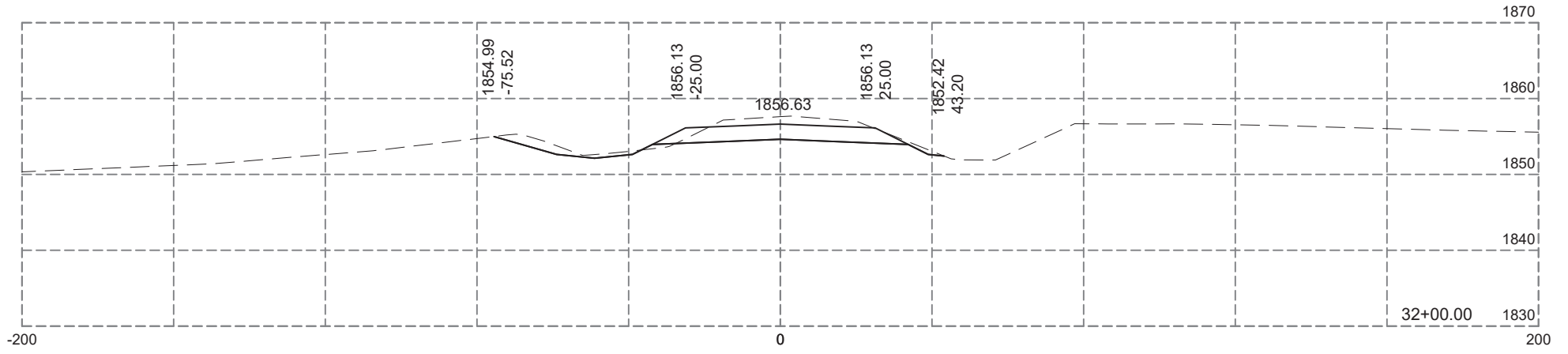

Plotting Date: 12-04-2024

STATE OF SOUTH DAKOTA	PROJECT	SHEET	TOTAL SHEETS
	P-PH-PT 0025(81)158	X94	X99

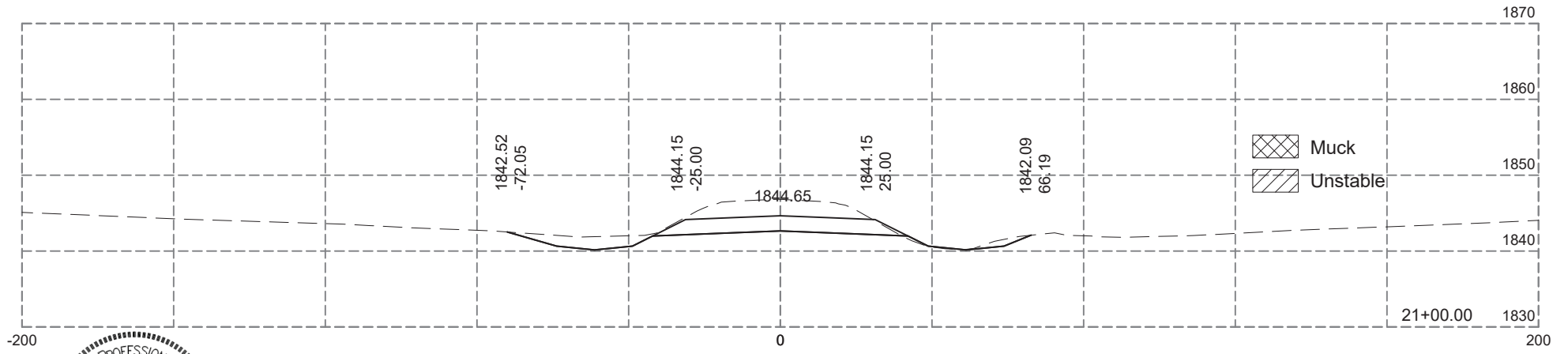
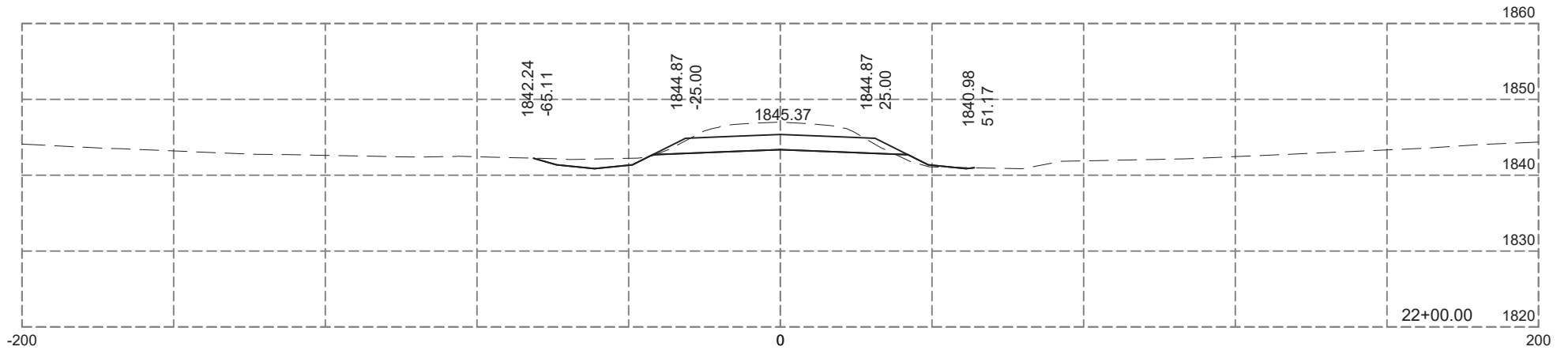
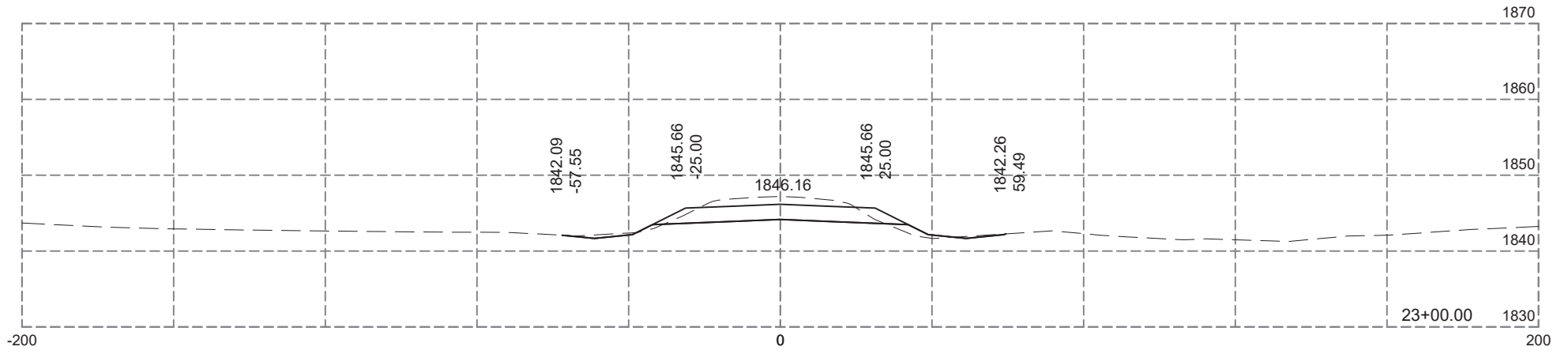
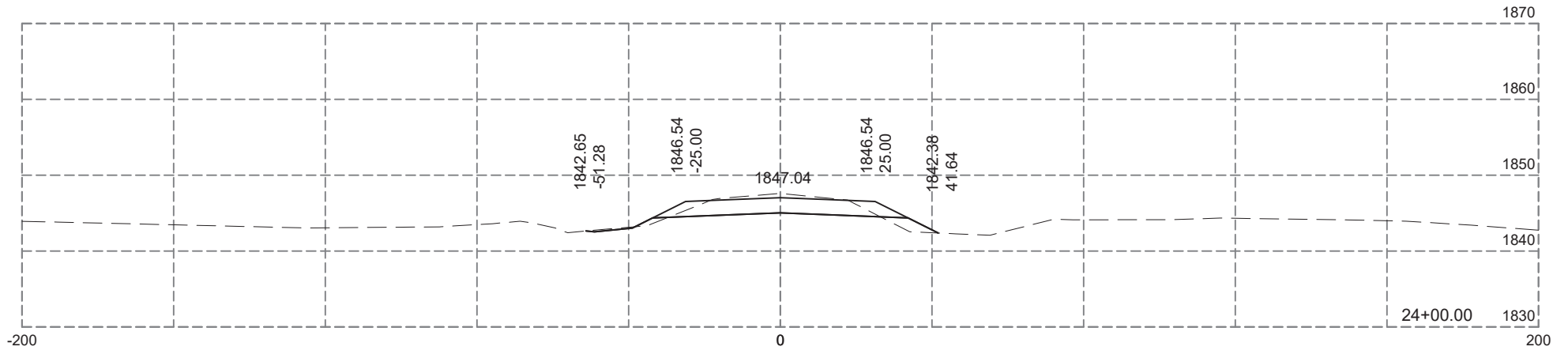
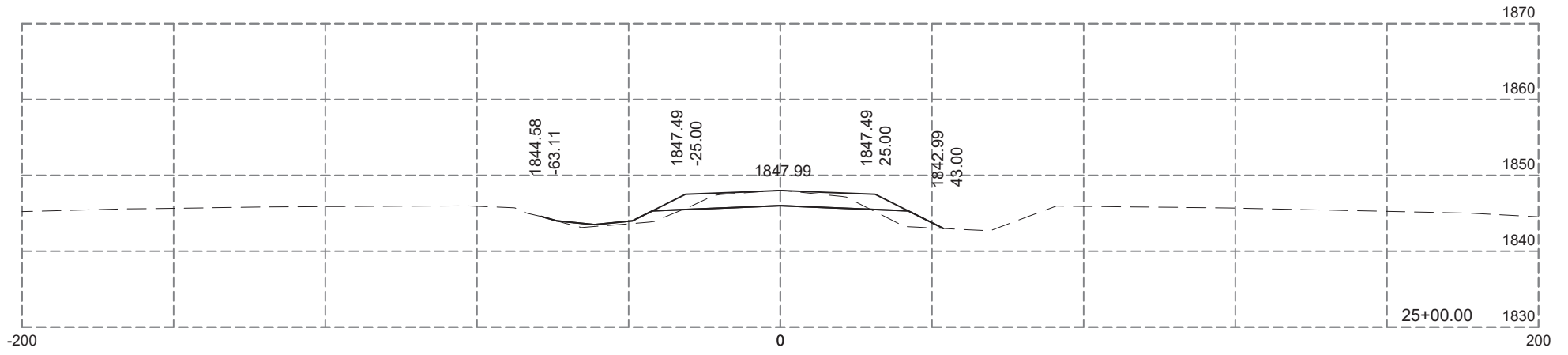
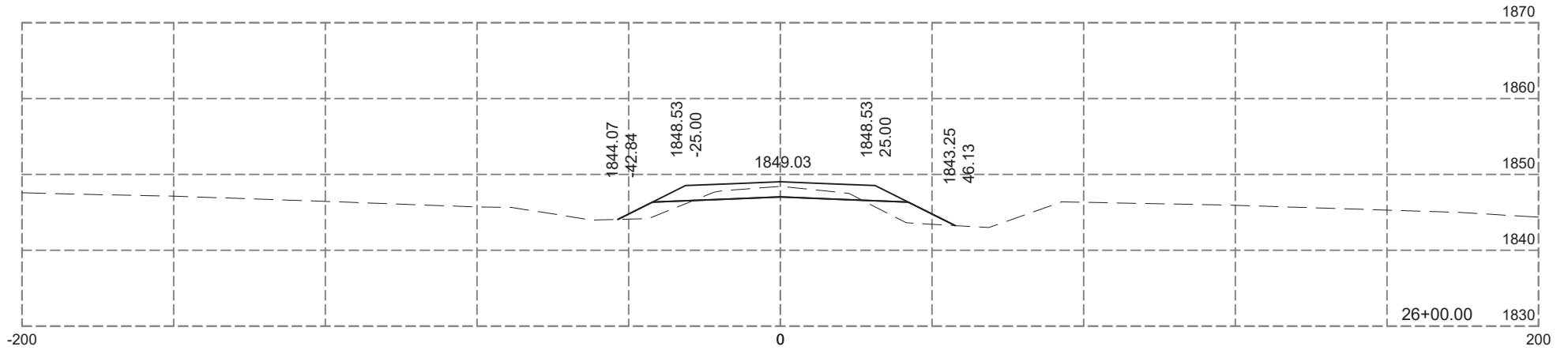

 Muck  
 Unstable



Plotting Date: 12-04-2024

STATE OF SOUTH DAKOTA	PROJECT	SHEET	TOTAL SHEETS
	P-PH-PT 0025(81)158	X95	X99

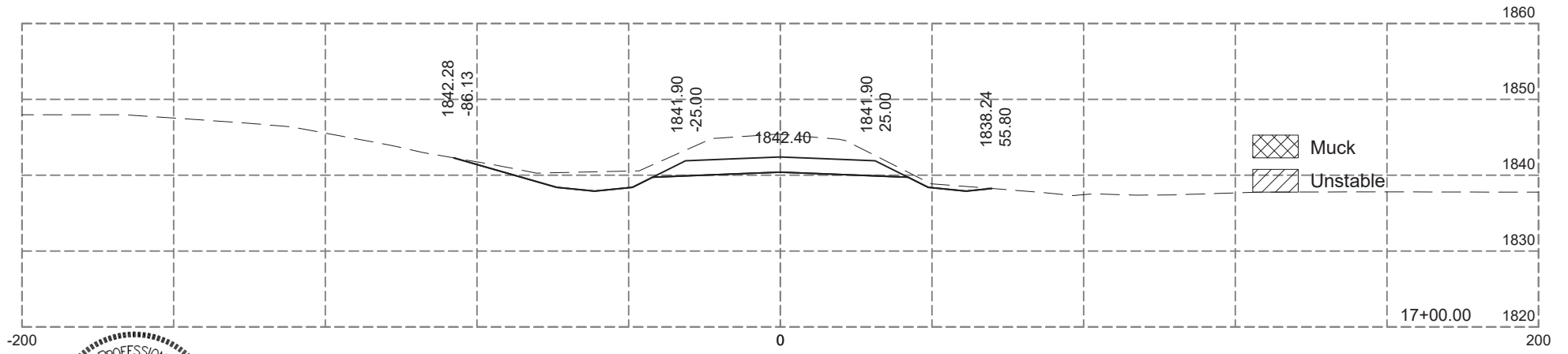
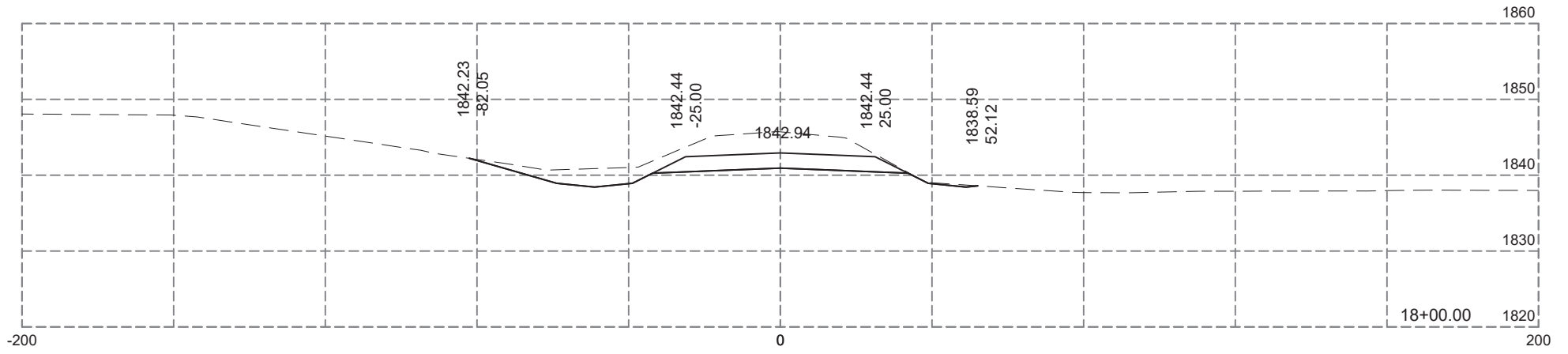
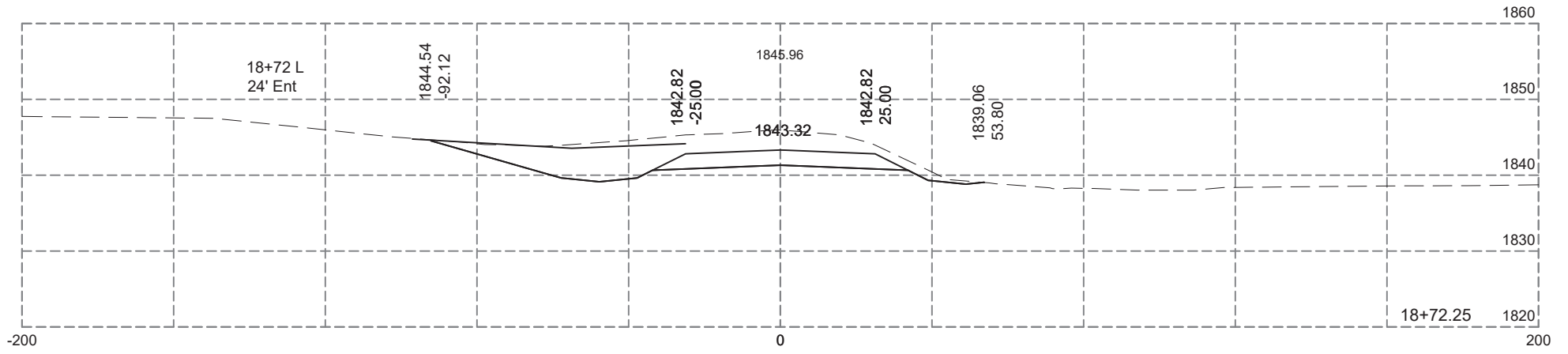
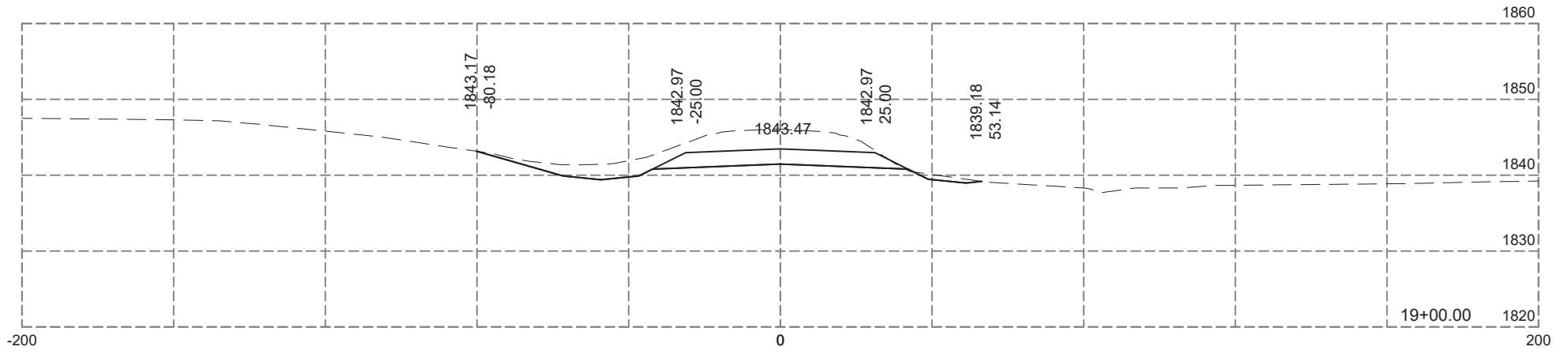
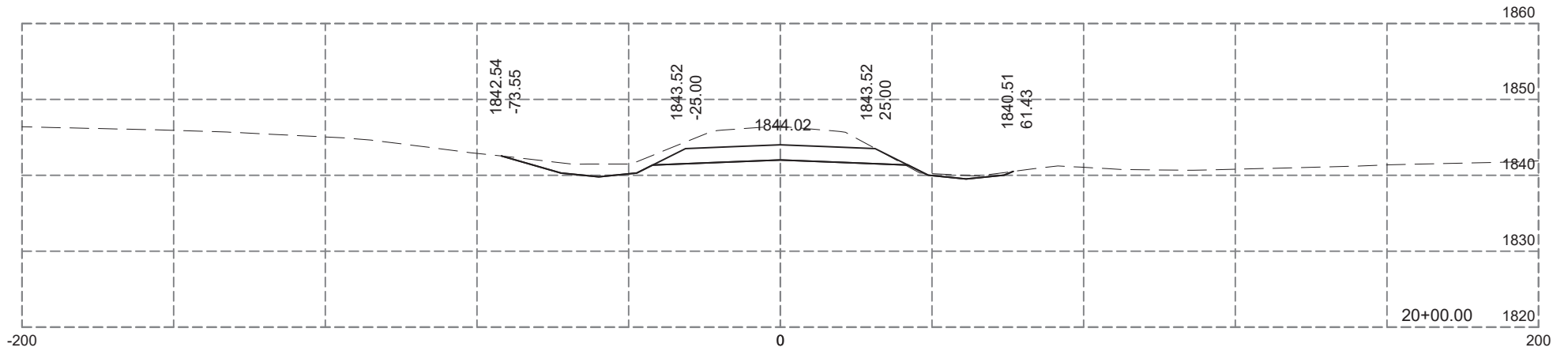
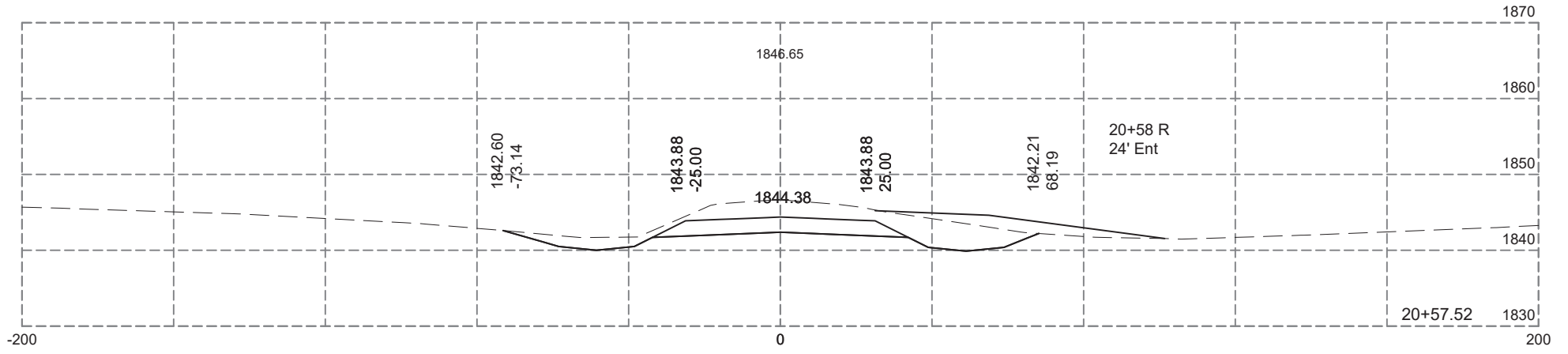

 Muck  
 Unstable



Plotting Date: 12-04-2024

STATE OF SOUTH DAKOTA	PROJECT P-PH-PT 0025(81)158	SHEET X96	TOTAL SHEETS X99
-----------------------	--------------------------------	--------------	---------------------



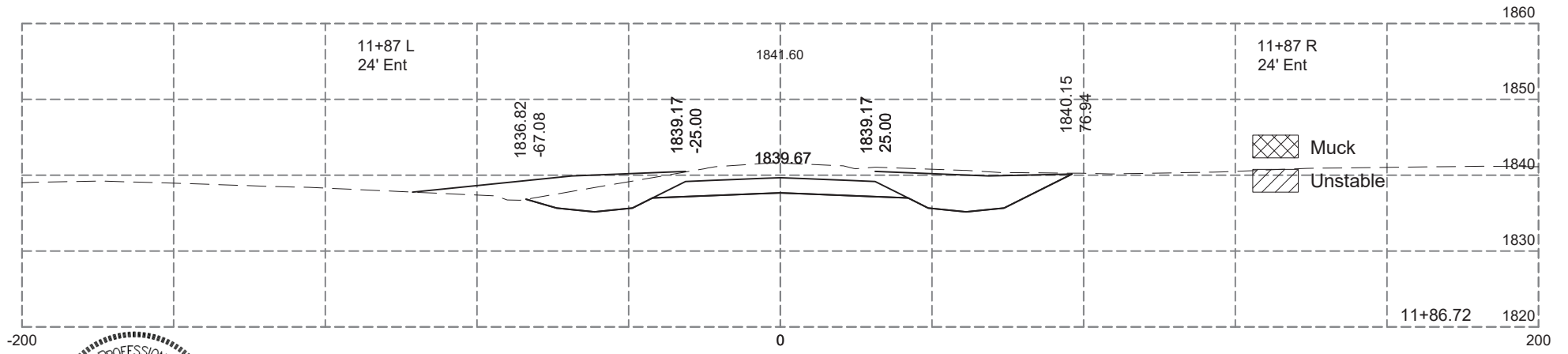
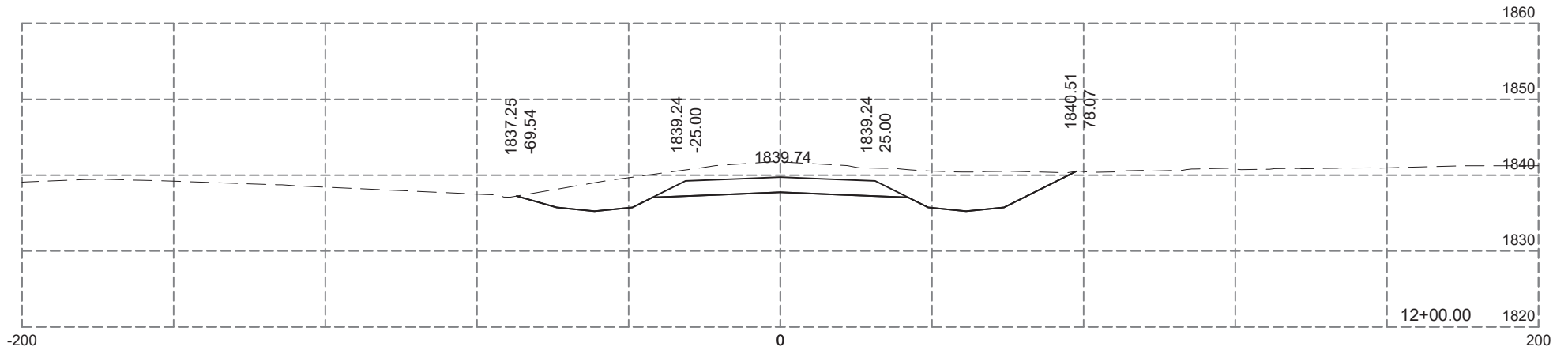
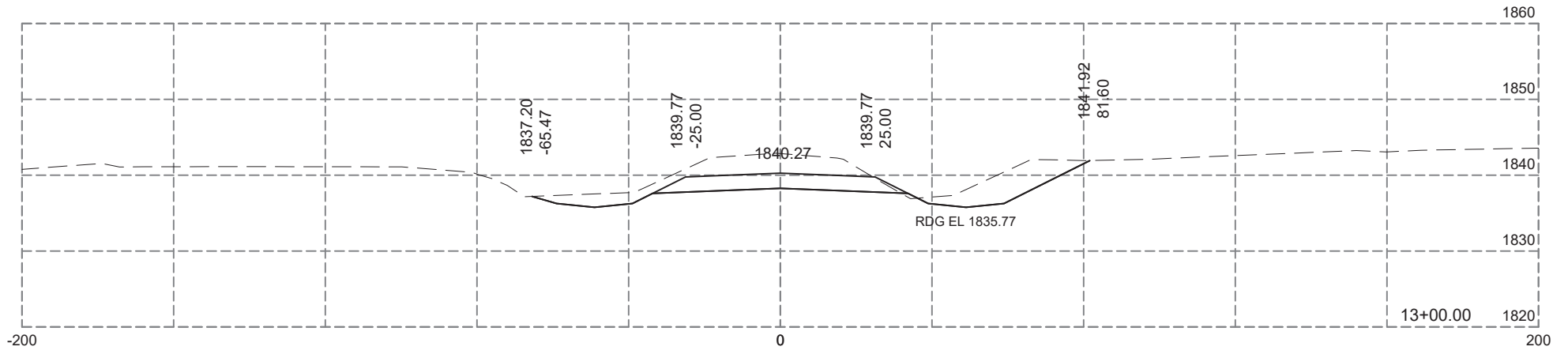
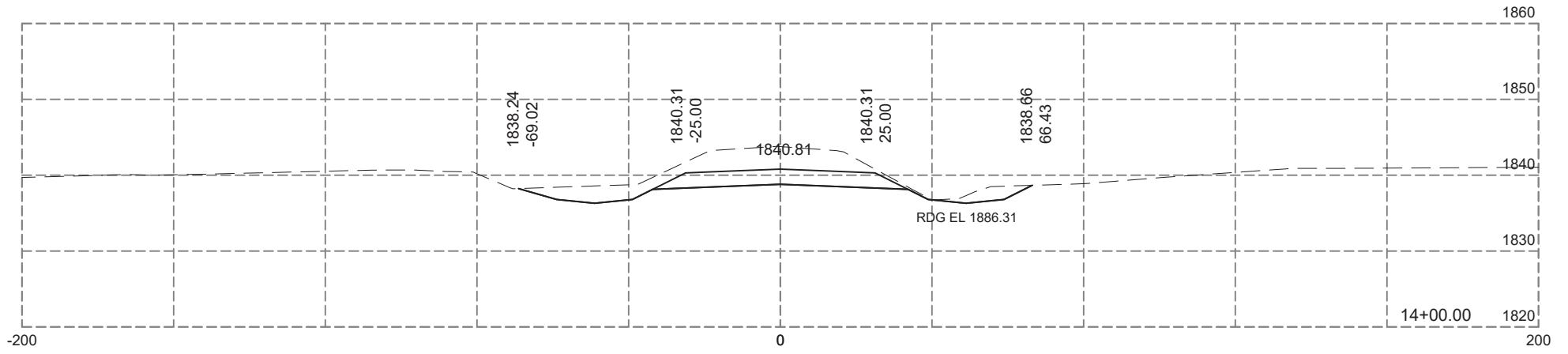
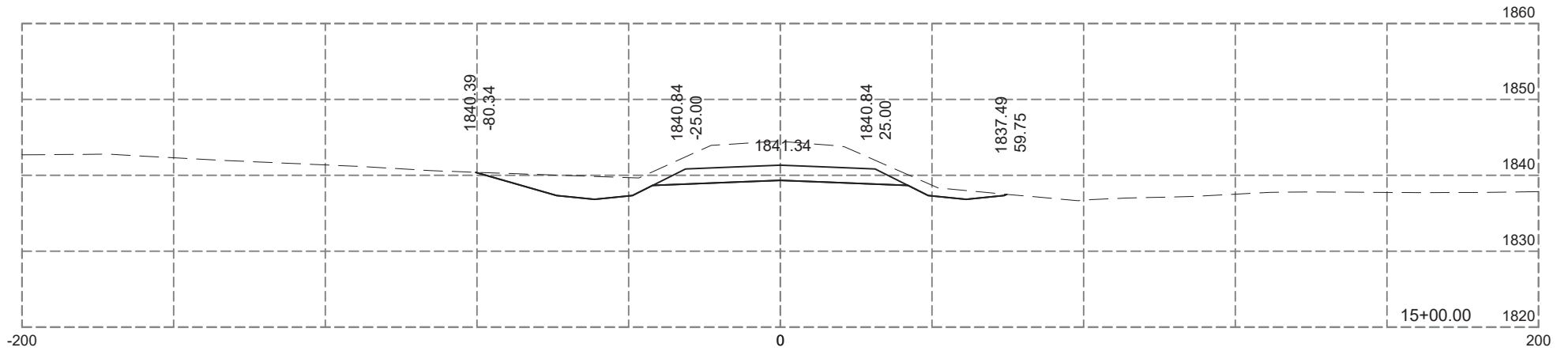
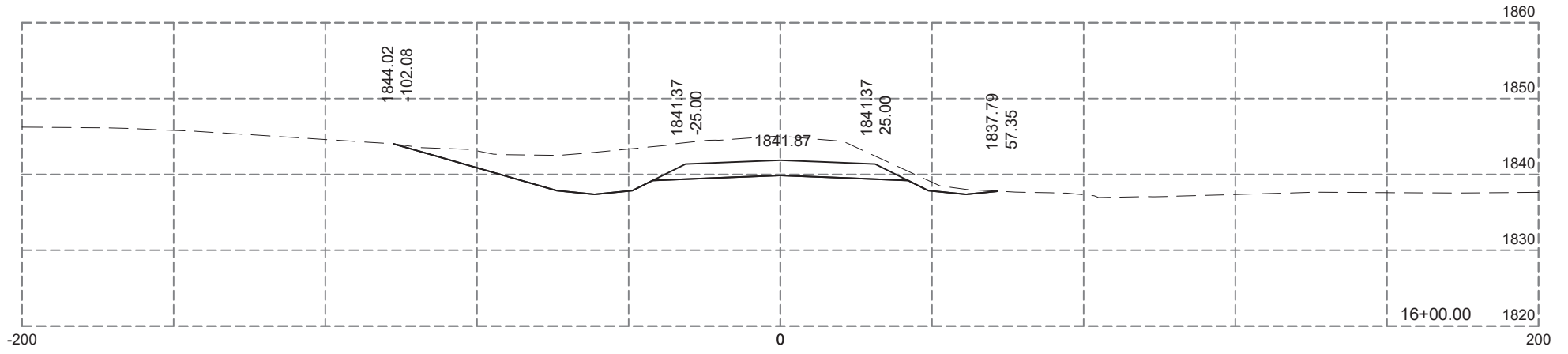

Plotting Date: 12-04-2024

STATE OF SOUTH DAKOTA	PROJECT P-PH-PT 0025(81)158	SHEET X97	TOTAL SHEETS X99
-----------------------	--------------------------------	--------------	---------------------

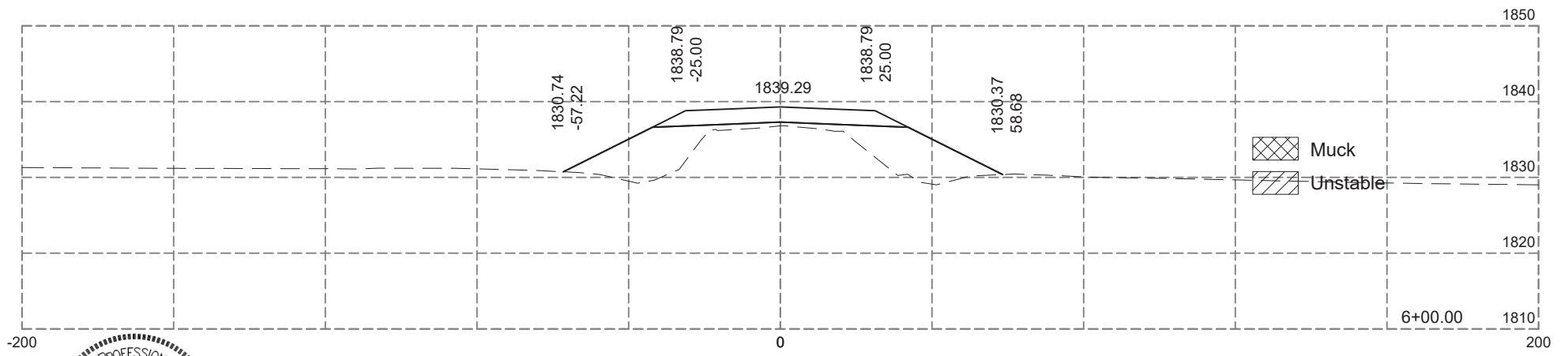
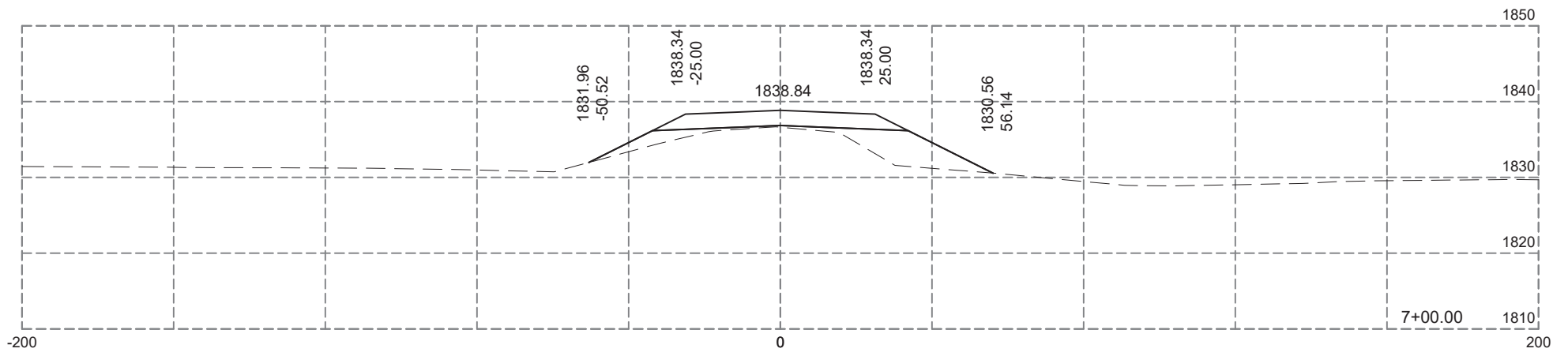
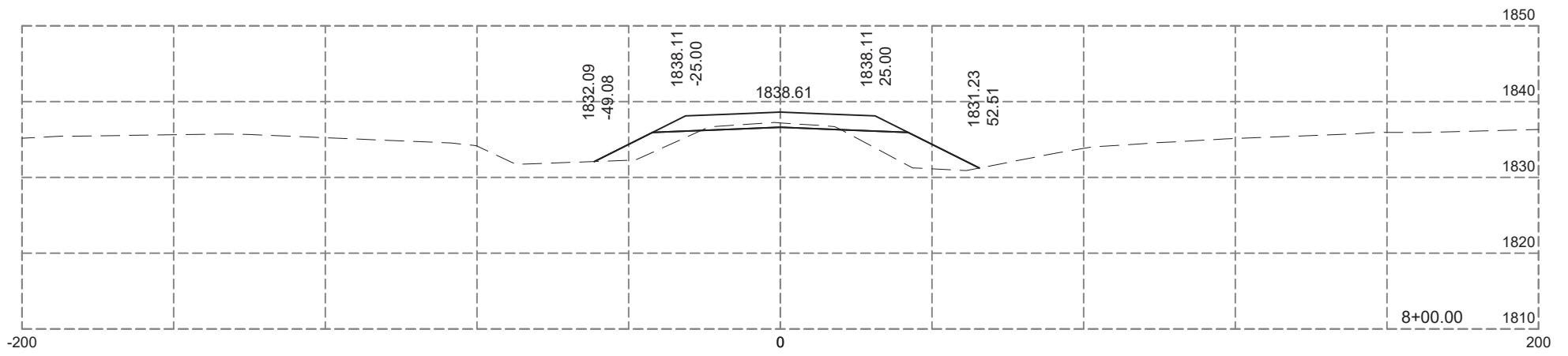
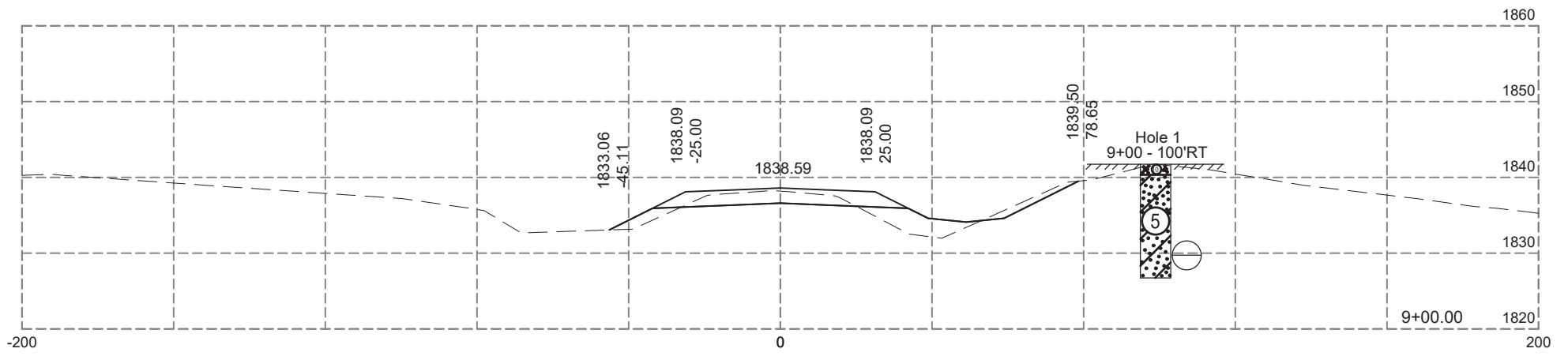
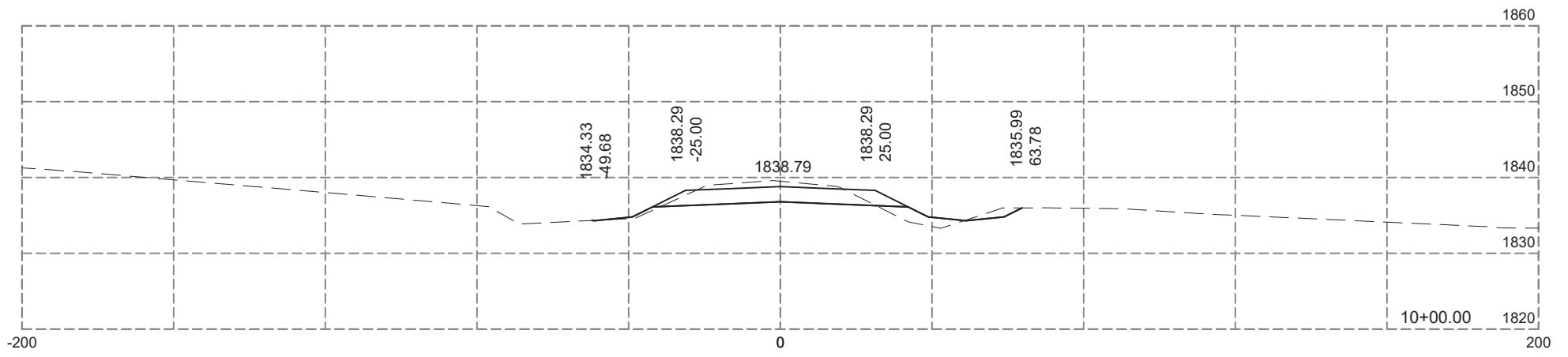
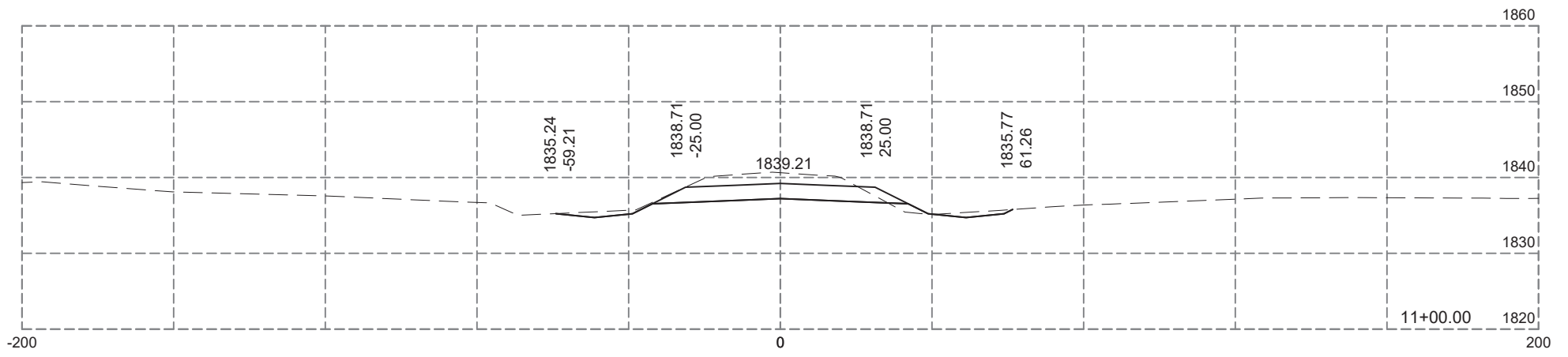

Plotting Date: 12-04-2024

STATE OF SOUTH DAKOTA	PROJECT P-PH-PT 0025(81)158	SHEET X98	TOTAL SHEETS X99
-----------------------	--------------------------------	--------------	---------------------

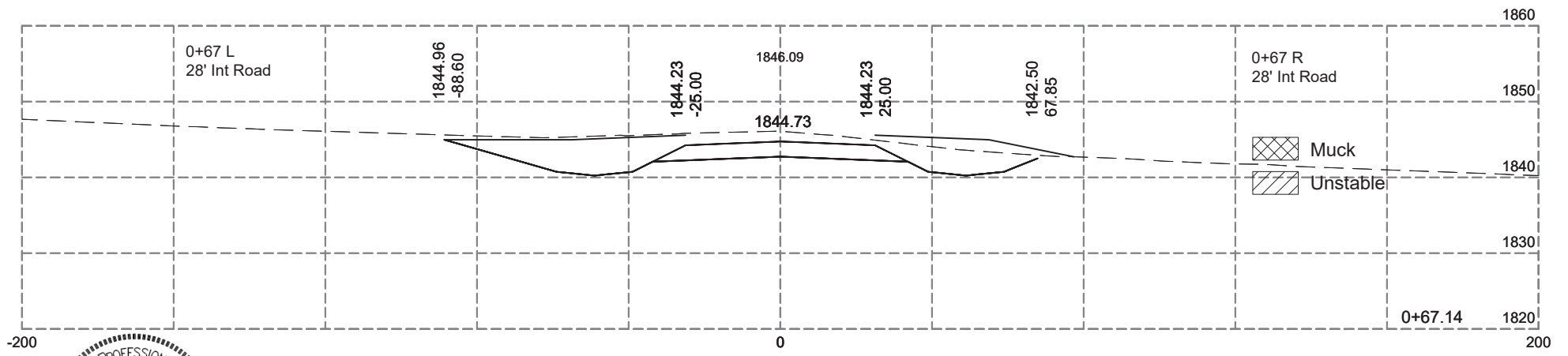
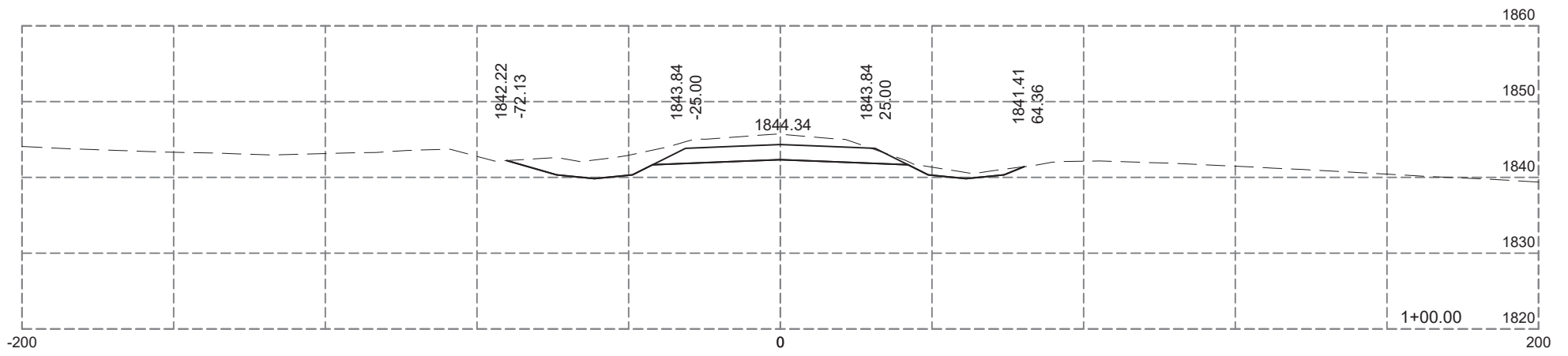
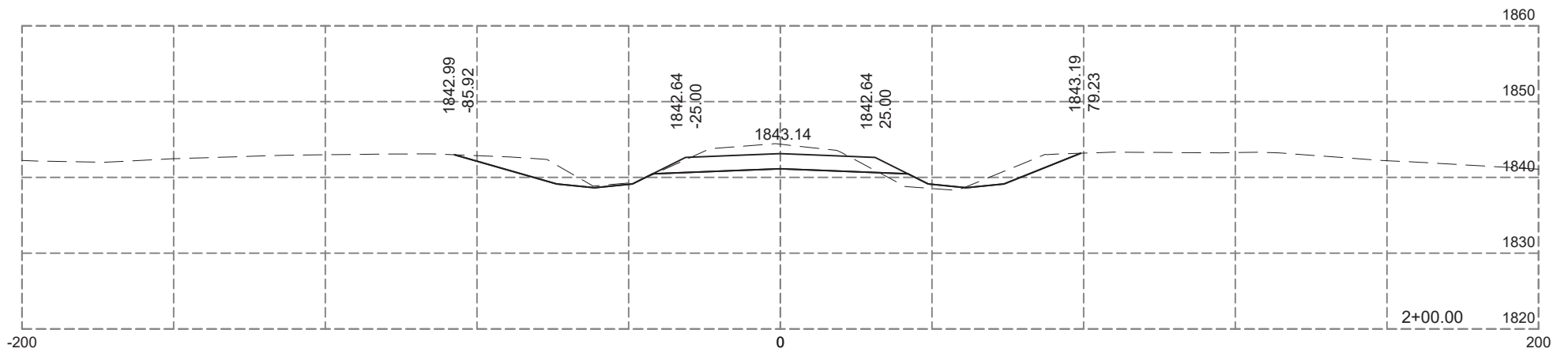
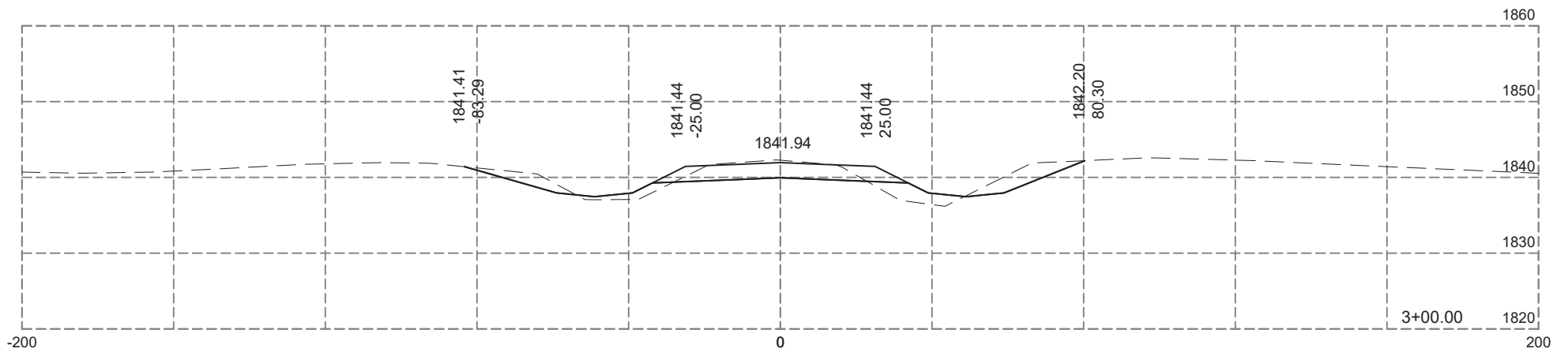
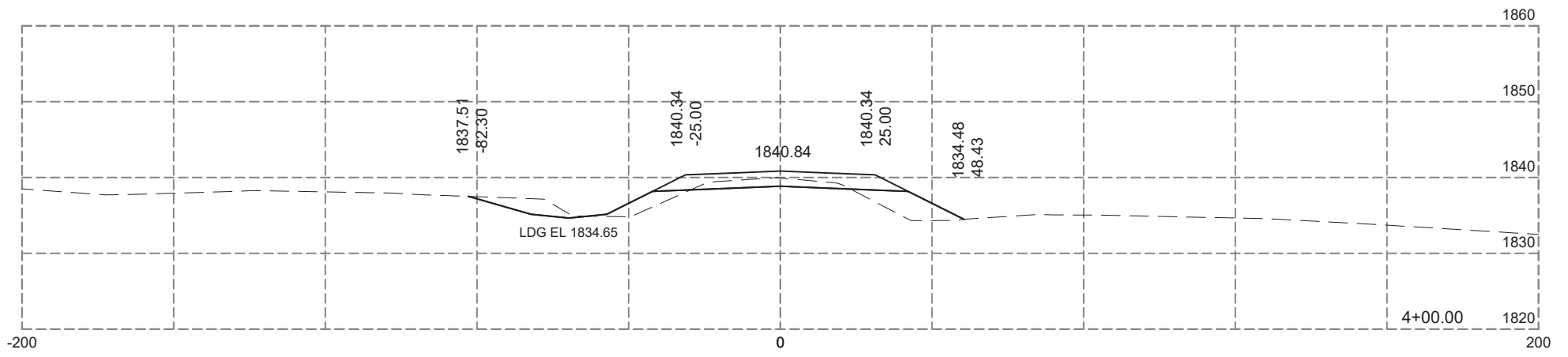
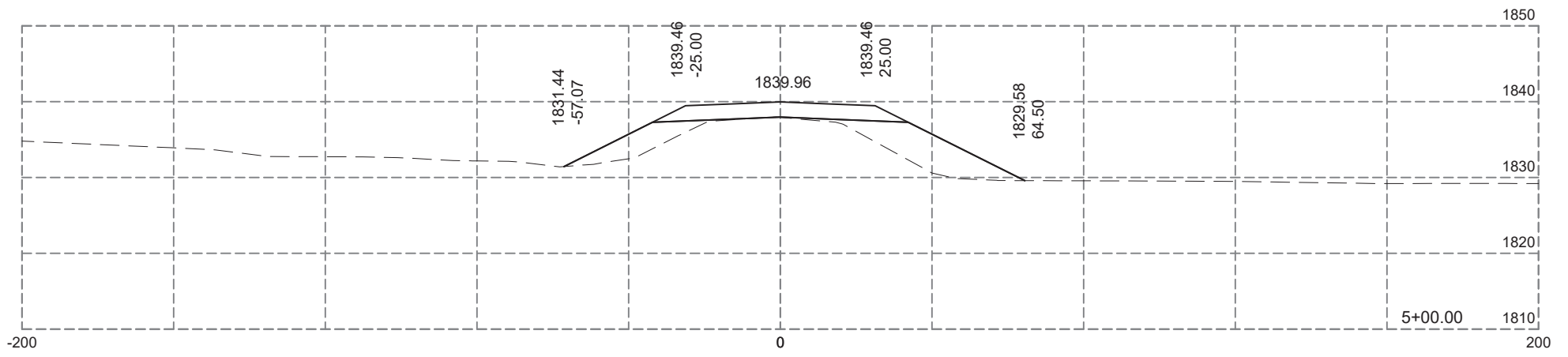

Plotting Date: 12-04-2024

STATE OF SOUTH DAKOTA	PROJECT P-PH-PT 0025(81)158	SHEET X99	TOTAL SHEETS X99
-----------------------	--------------------------------	--------------	---------------------