

SECTION Z: PIPE CROSS SECTIONS

FOR BIDDING PURPOSES ONLY

STATE OF SOUTH DAKOTA	PROJECT	SHEET	TOTAL SHEETS
	P 0047(117)67 P 0248(13)261	Z1	Z28

REV 12-4-24 JT

INDEX OF SHEETS

- Z1 General Layout with Index
- Z2-Z27 SD 47 Mainline Pipe Sections
- Z28 SD 248 Mainline Pipe Sections

BEGIN P 0248(13)261
Station 0+00.00
MRM 261.77

END P 0248(13)261
Station 43+82.00
MRM 262.57

BEGIN P 0047(117)67
Station -2+50.00
MRM 87.00 + 0.346

END P 0047(117)67
Station 1024+81.32
MRM 67.00 + 0.602

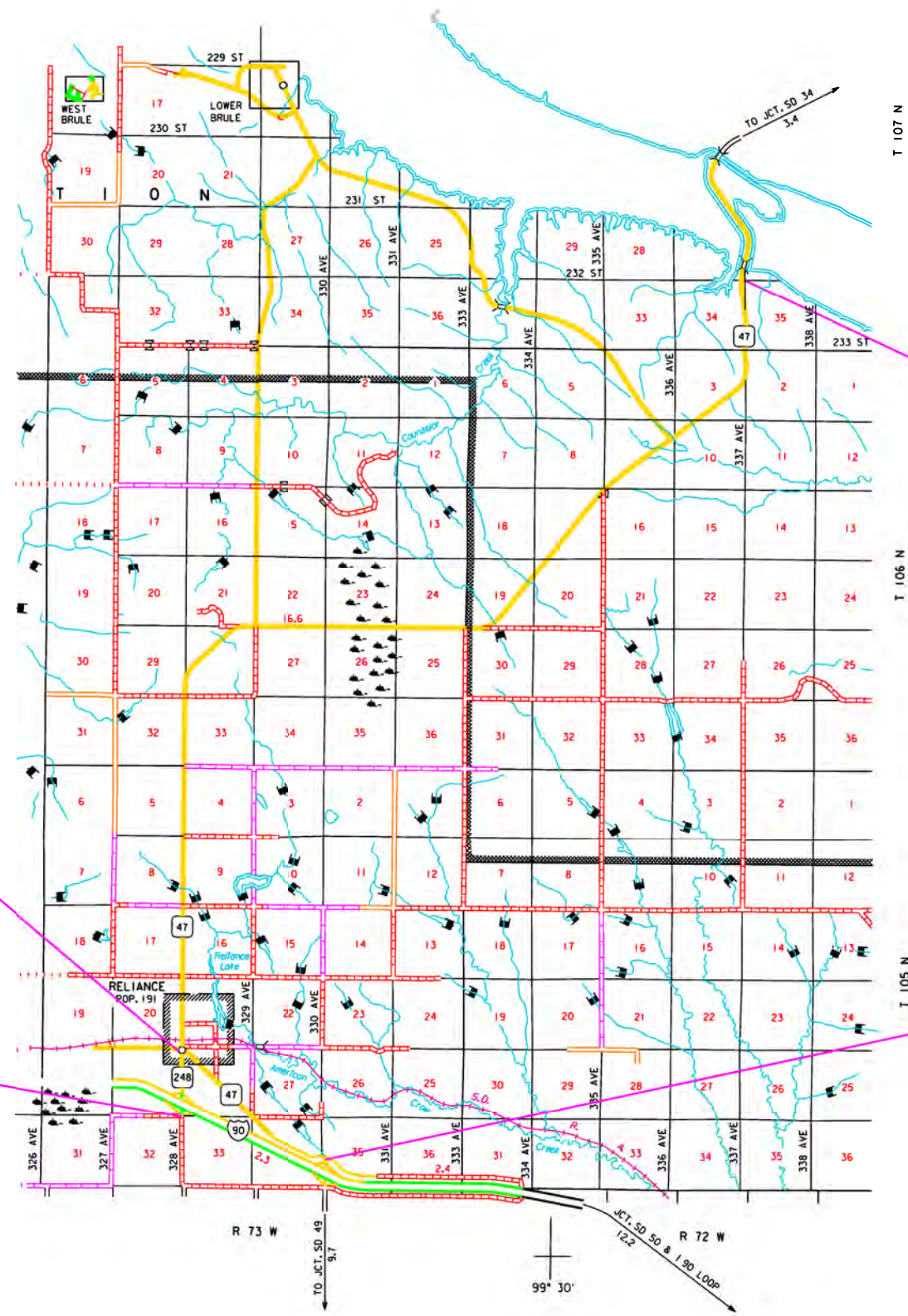

Plotting Date: 08-12-24

FOR BIDDING PURPOSES ONLY

STATE OF SOUTH DAKOTA	PROJECT	SHEET	TOTAL SHEETS
	P 0047(117)67 P 0248(13)261	Z2	Z28

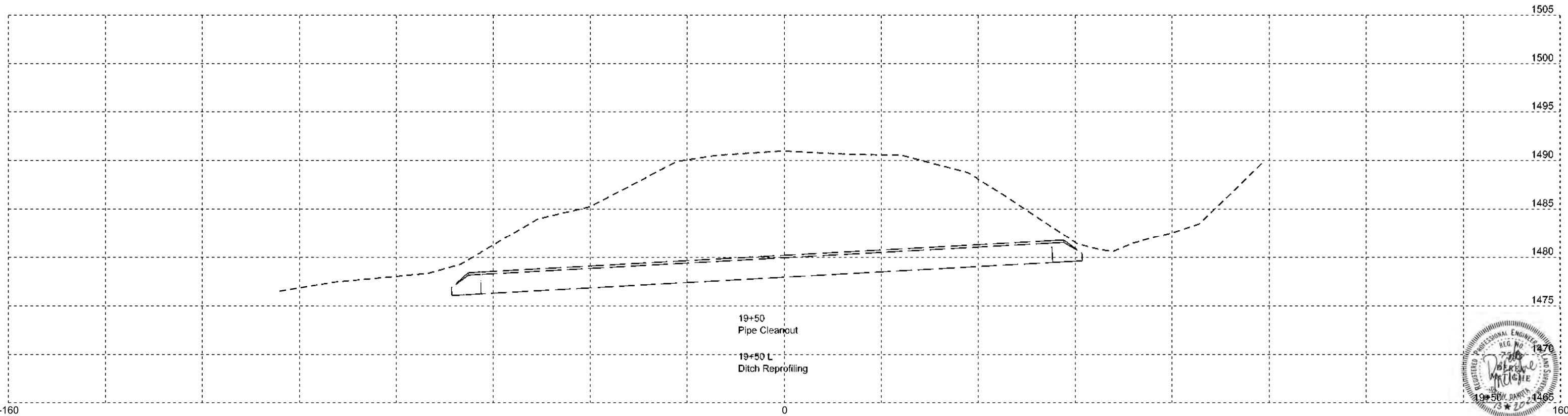

STATE OF SOUTH DAKOTA	PROJECT	SHEET	TOTAL SHEETS
	P 0047(117)67 P 0248(13)261	Z3	Z28

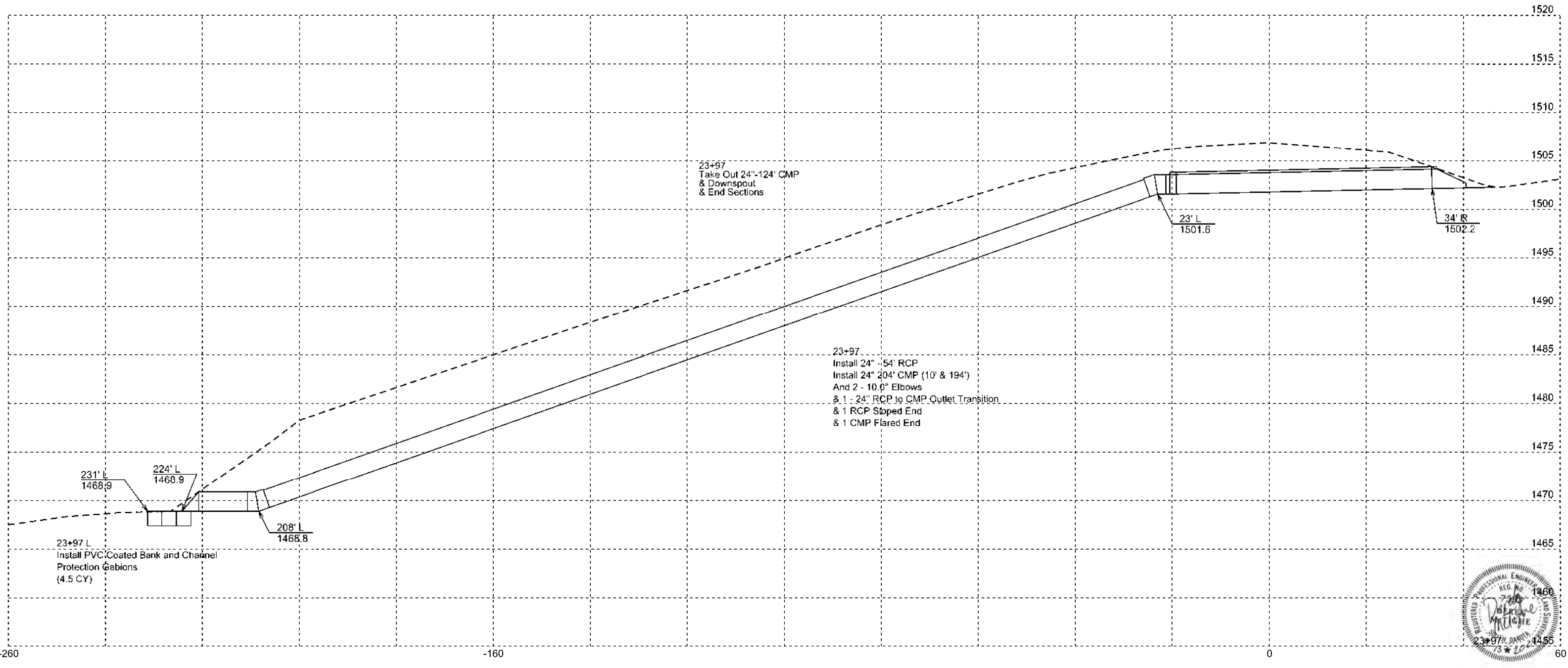

STATE OF SOUTH DAKOTA	PROJECT	SHEET	TOTAL SHEETS
		Z4	Z28

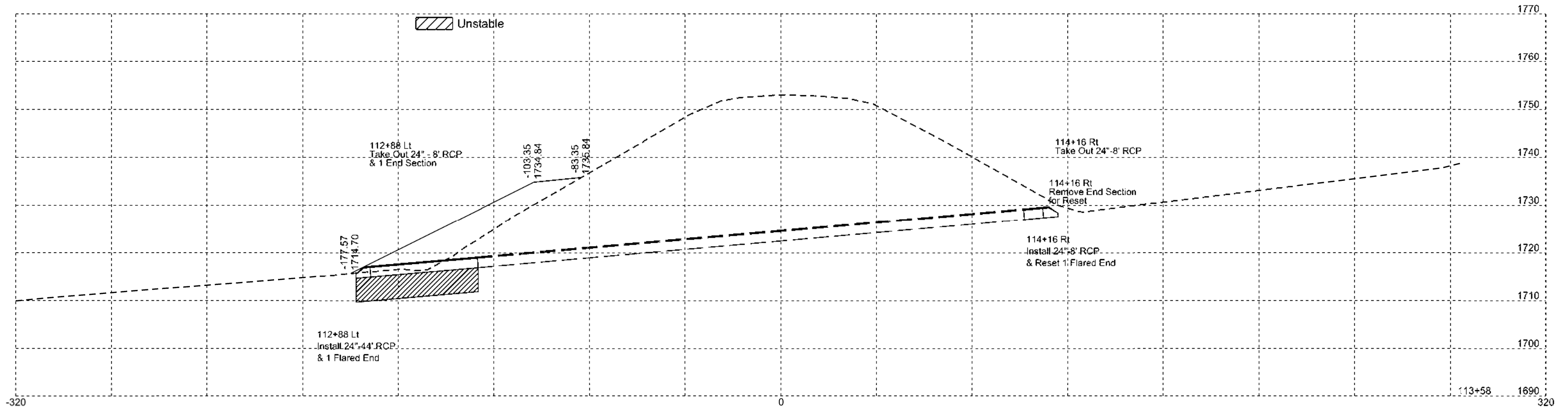

STATE OF SOUTH DAKOTA	PROJECT	SHEET	TOTAL SHEETS
	P 0047(117)67	Z5	Z28
	P 0248(13)261		

 Unstable

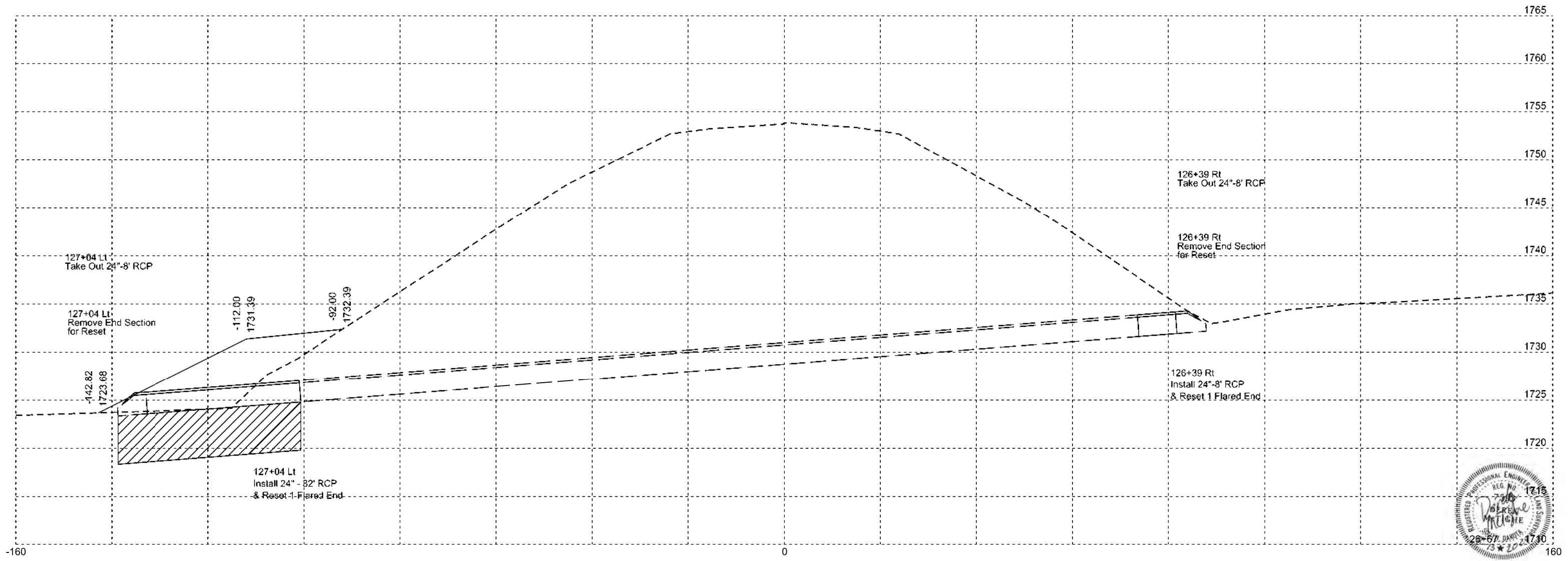

Plotting Date: 08-12-24

FOR BIDDING PURPOSES ONLY

STATE OF SOUTH DAKOTA	PROJECT	SHEET	TOTAL SHEETS
	P 0047(117)67	Z6	Z28
	P 0248(13)261		

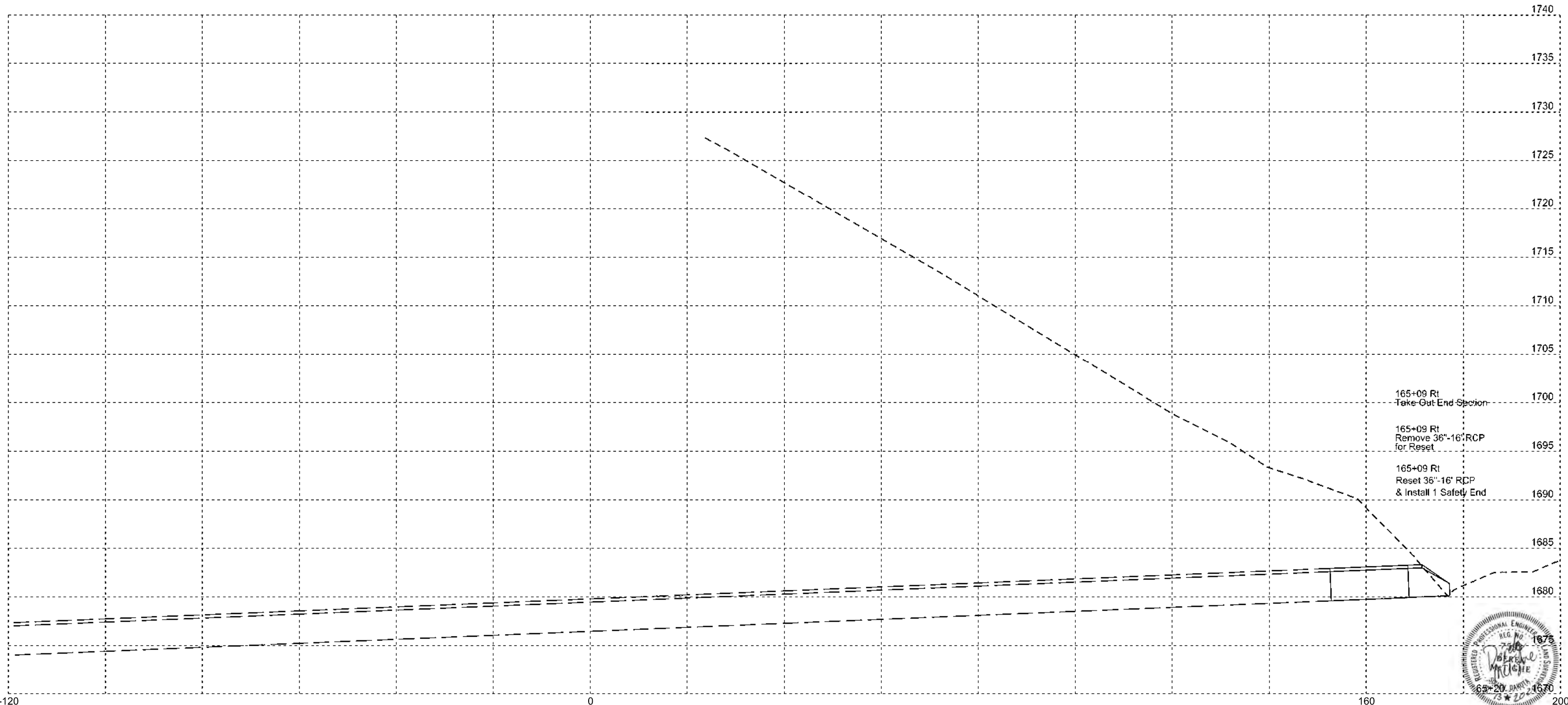

STATE OF SOUTH DAKOTA	PROJECT	SHEET	TOTAL SHEETS
	P 0047(117)67 P 0248(13)261	Z7	Z28

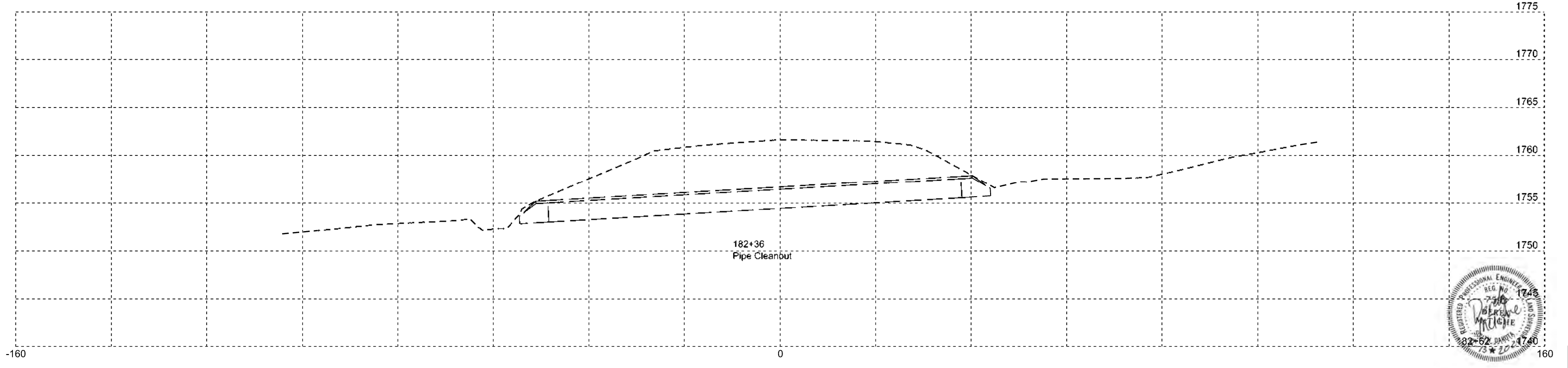
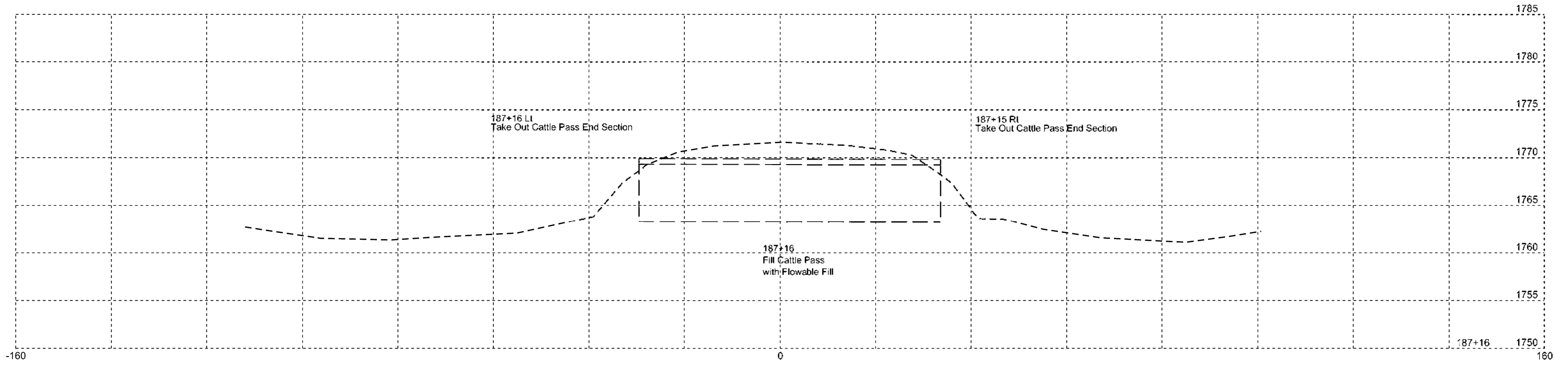

FOR BIDDING PURPOSES ONLY

STATE OF SOUTH DAKOTA	PROJECT	SHEET	TOTAL SHEETS
	P 0047(117)67	Z8	Z28
	P 0248(13)261		

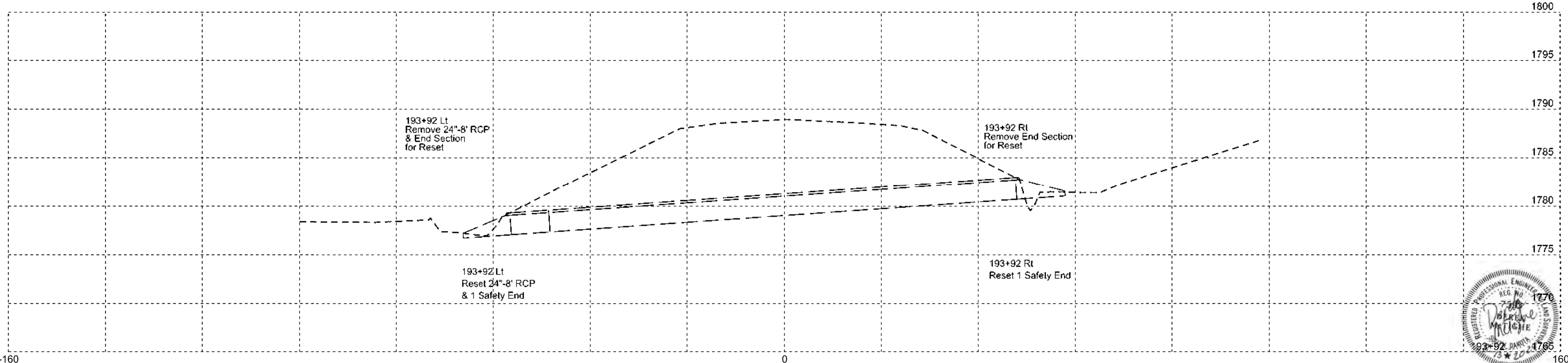

STATE OF SOUTH DAKOTA	PROJECT	SHEET	TOTAL SHEETS
	P 0047(117)67 P 0248(13)261	Z9	Z28

Unstable

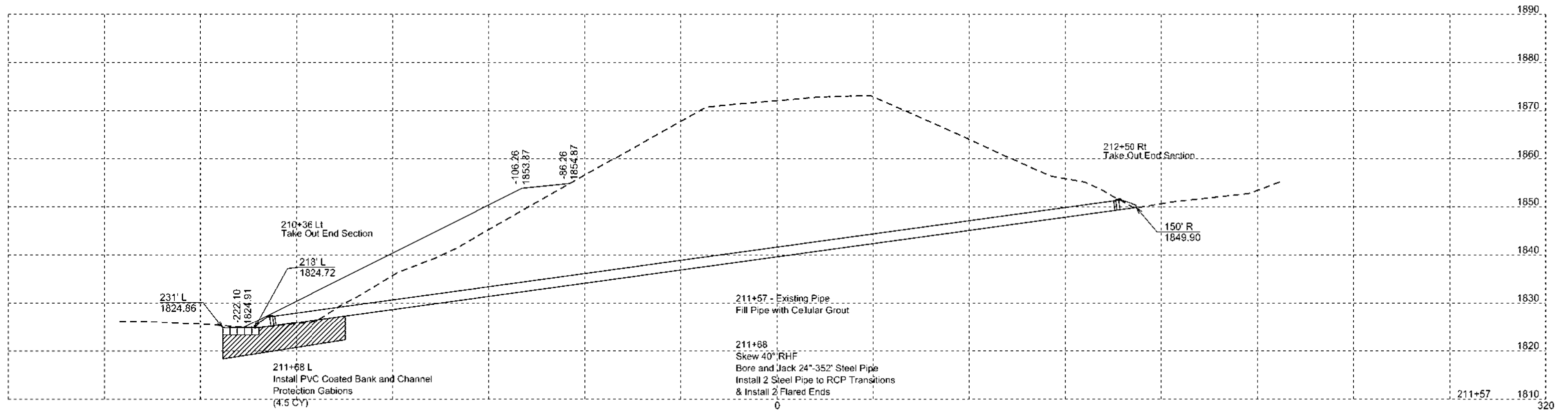

Plotting Date: 08-12-24

FOR BIDDING PURPOSES ONLY

STATE OF SOUTH DAKOTA	PROJECT	SHEET	TOTAL SHEETS
	P 0047(117)67 P 0248(13)261	Z10	Z28

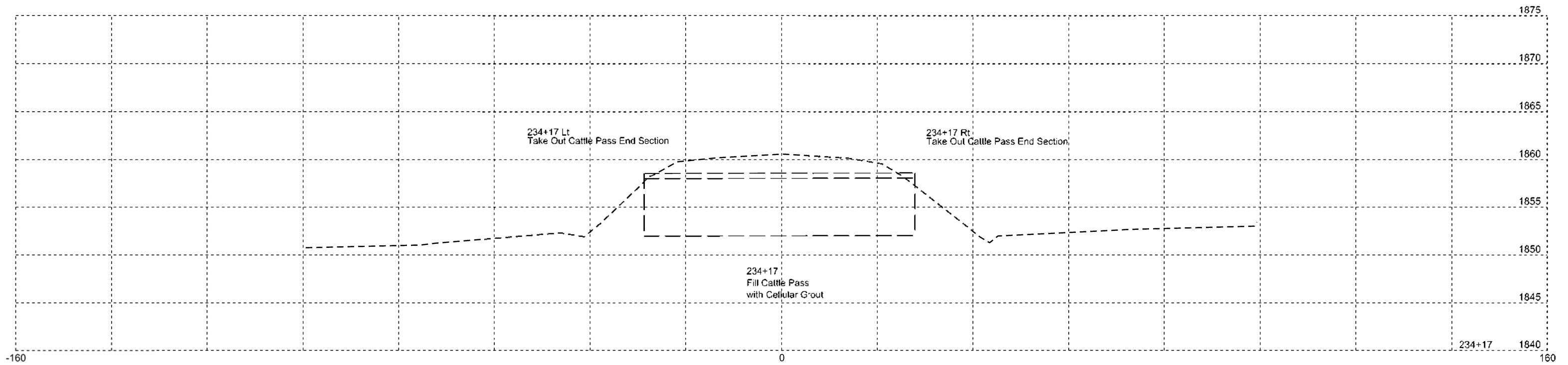

STATE OF SOUTH DAKOTA	PROJECT	SHEET	TOTAL SHEETS
	P 0047(117)67 P 0248(13)261	Z11	Z28

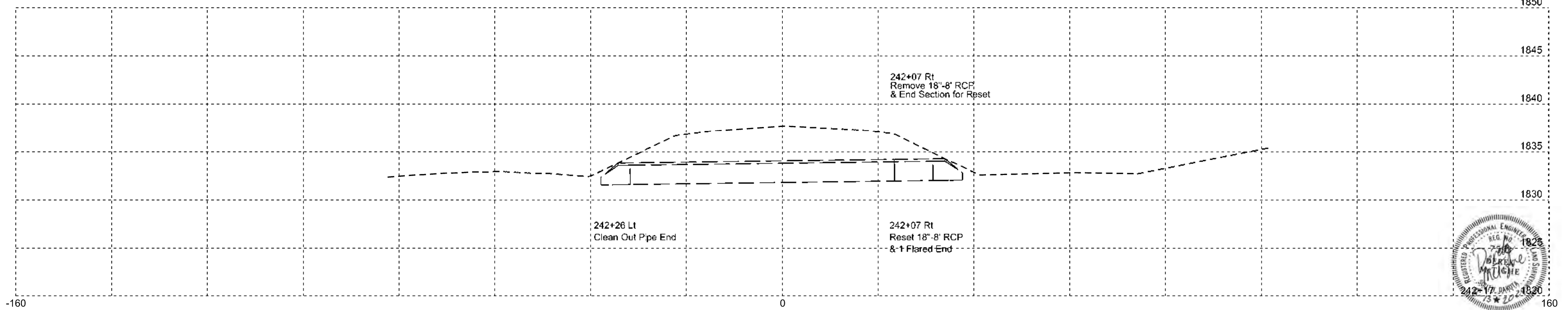
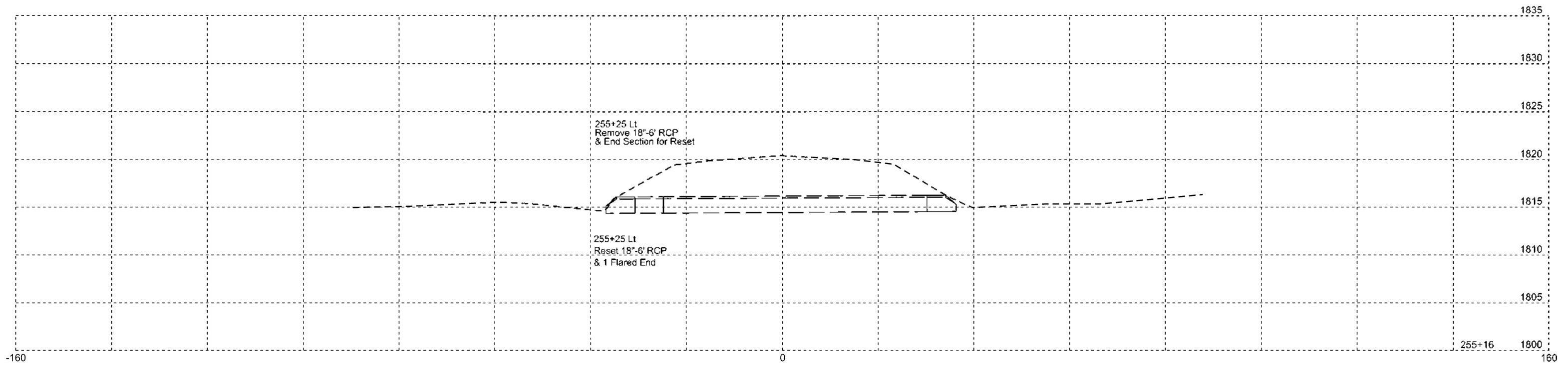

STATE OF SOUTH DAKOTA	PROJECT	SHEET	TOTAL SHEETS
	P 0047(117)67	Z12	Z28
	P 0248(13)261		

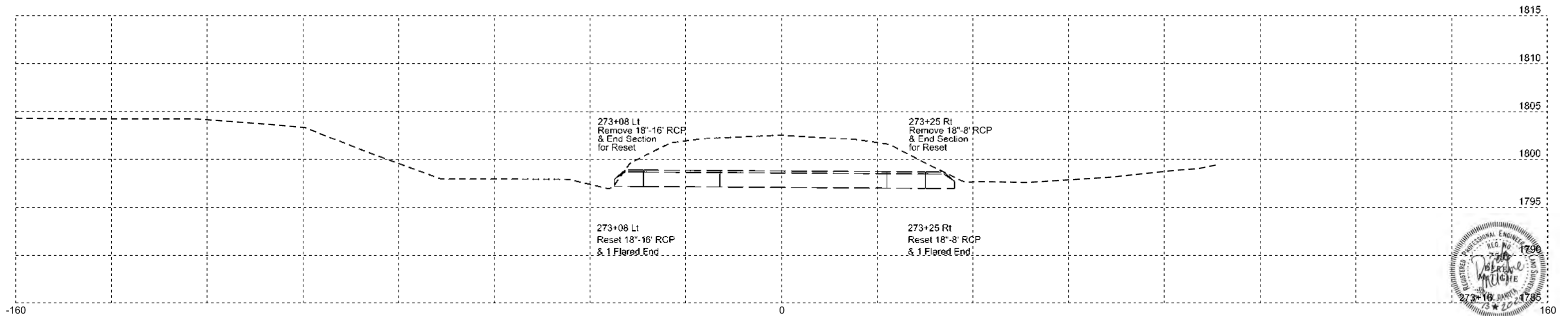
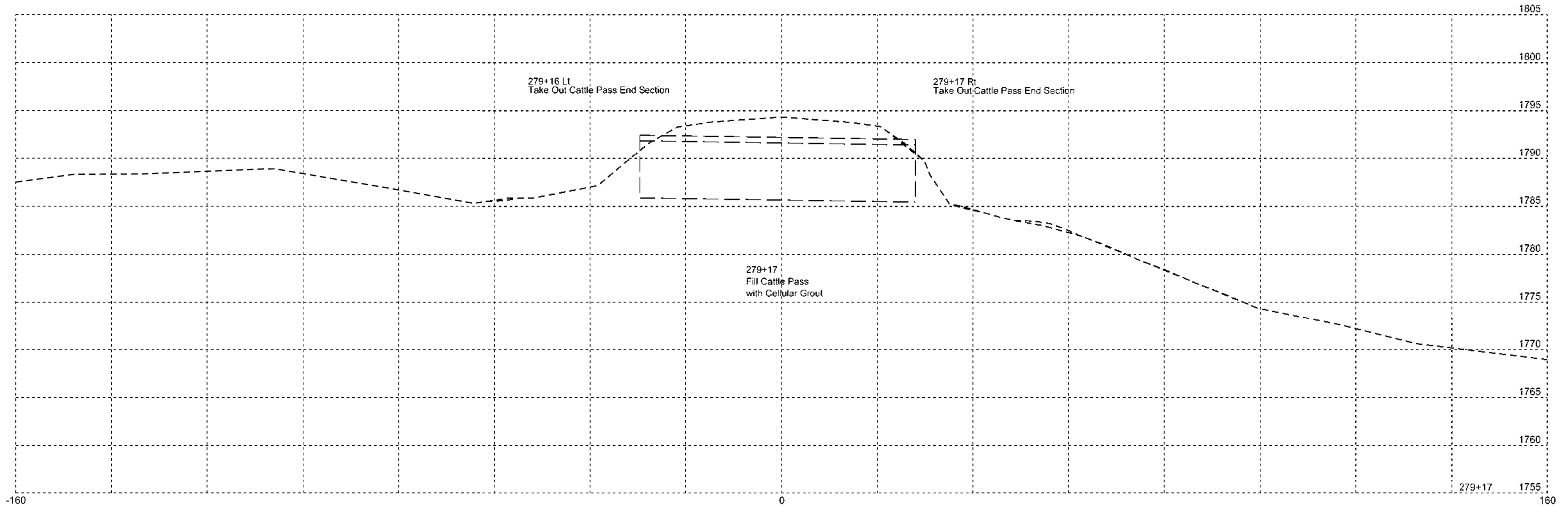

STATE OF SOUTH DAKOTA	PROJECT	SHEET	TOTAL SHEETS
	P 0047(117)67 P 0248(13)261	Z13	Z28

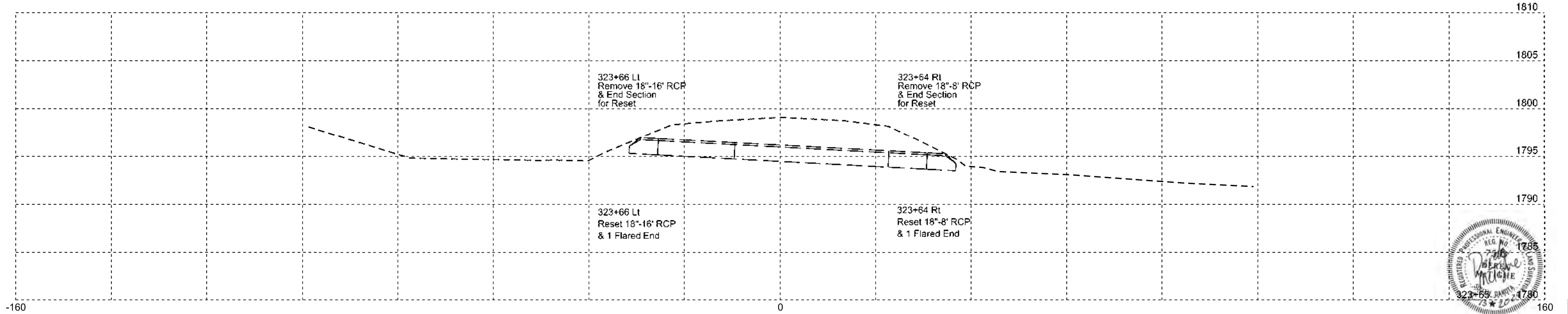
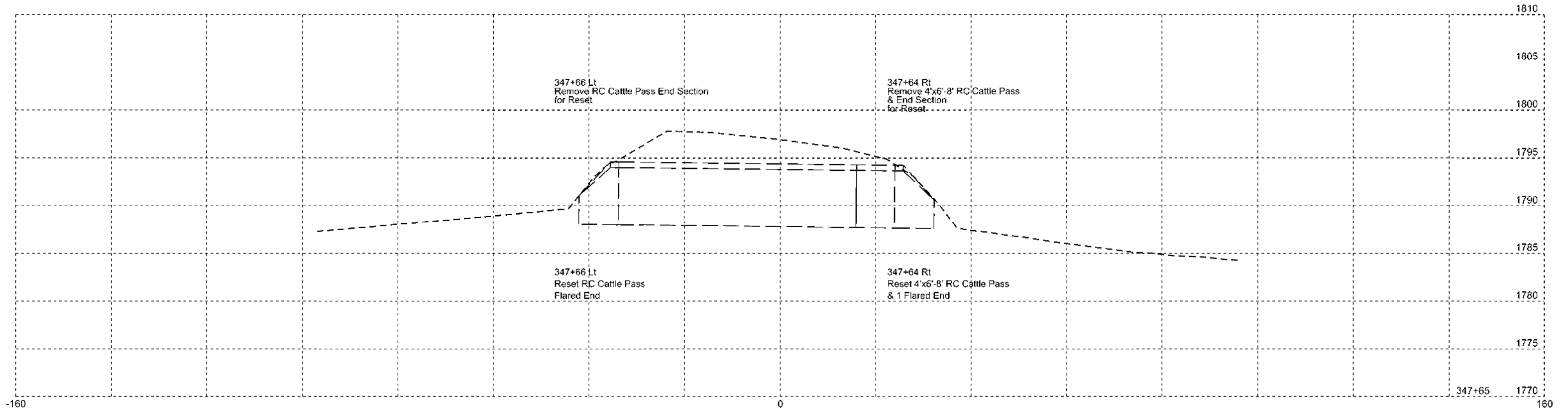

STATE OF SOUTH DAKOTA	PROJECT	SHEET	TOTAL SHEETS
	P 0047(117)67	Z14	Z28
	P 0248(13)261		

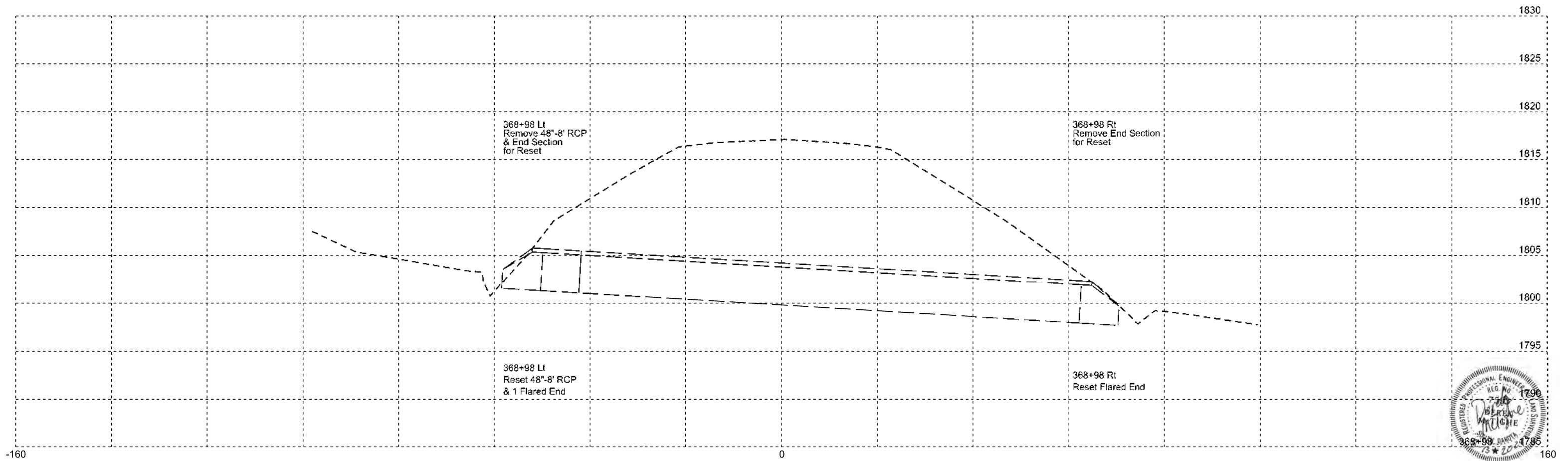
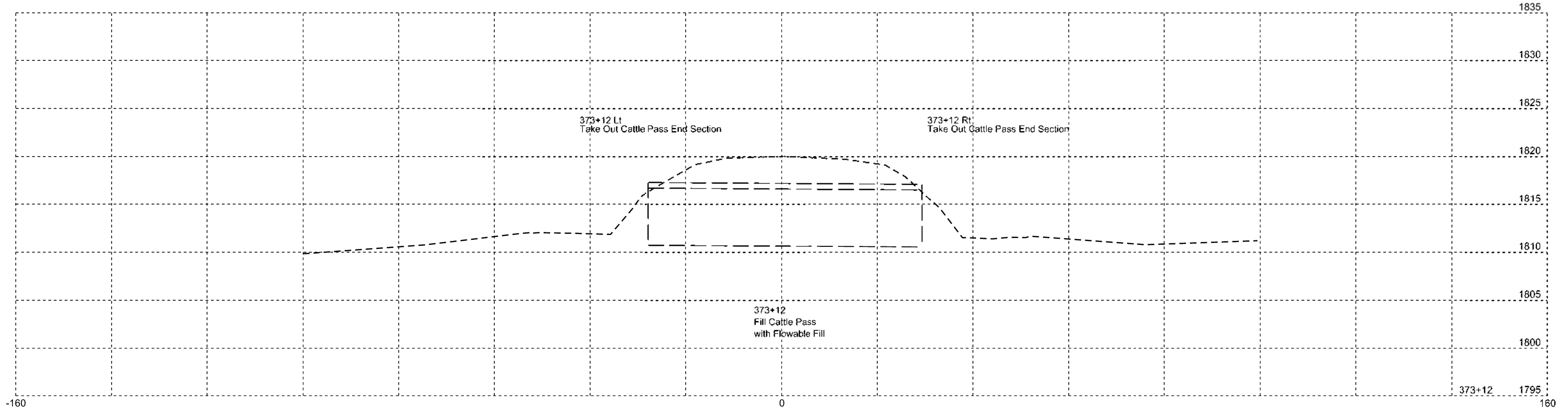

STATE OF SOUTH DAKOTA	PROJECT	SHEET	TOTAL SHEETS
	P 0047(117)67 P 0248(13)261	Z15	Z28

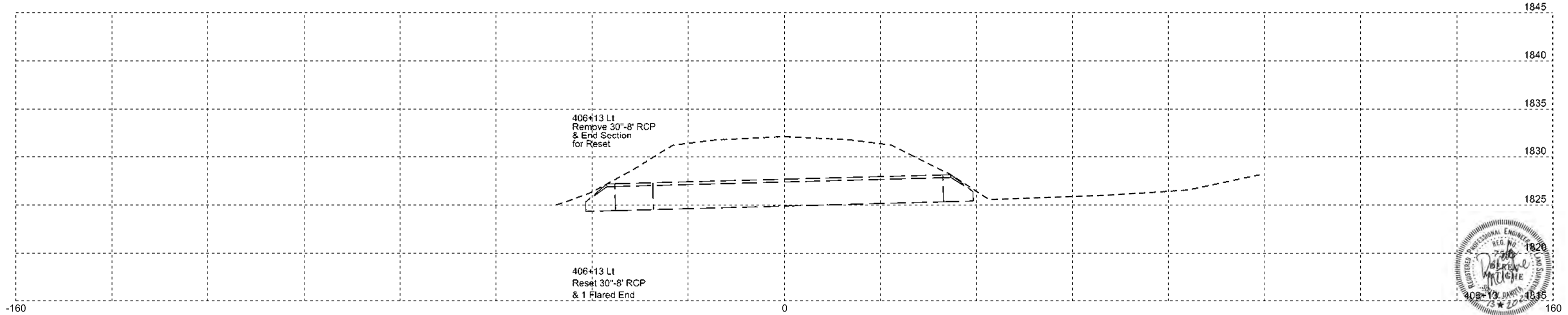
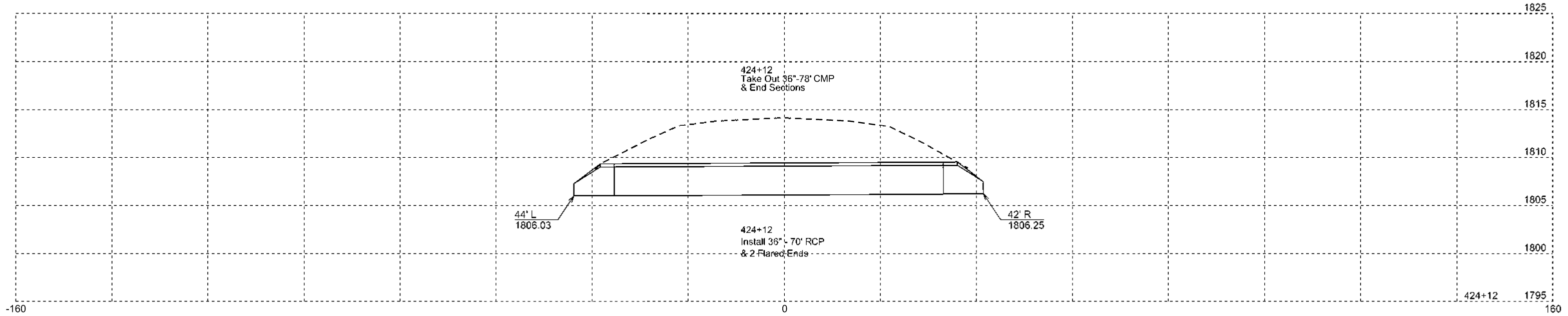
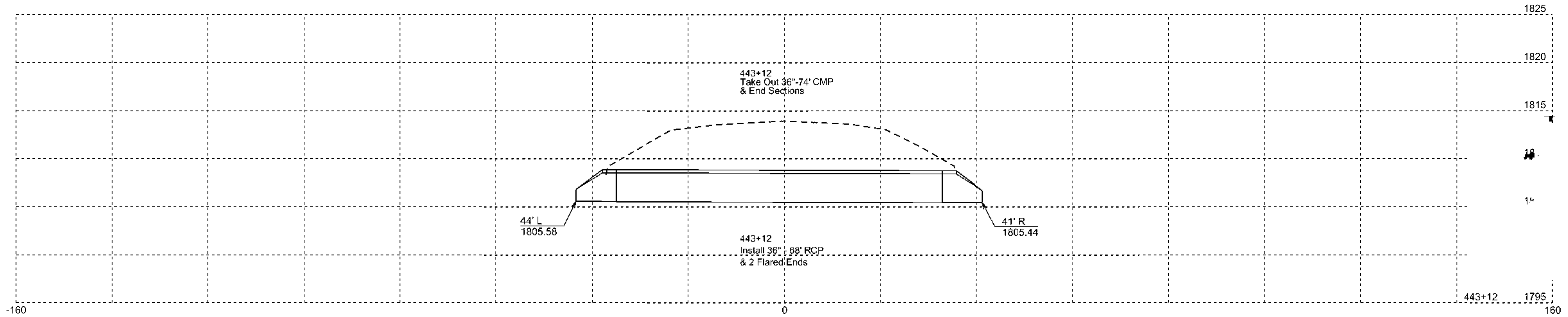

STATE OF SOUTH DAKOTA	PROJECT	SHEET	TOTAL SHEETS
	P 0047(117)67 P 0248(13)261	Z16	Z28

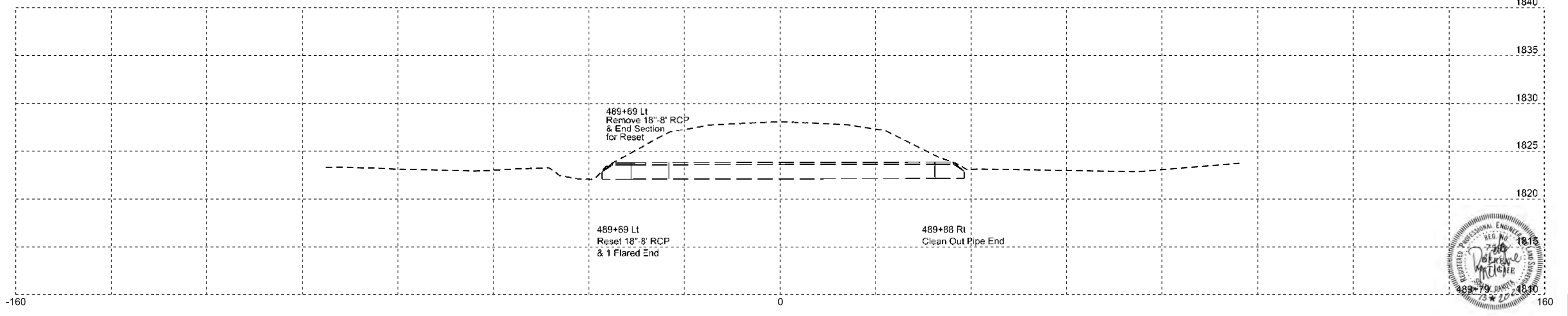
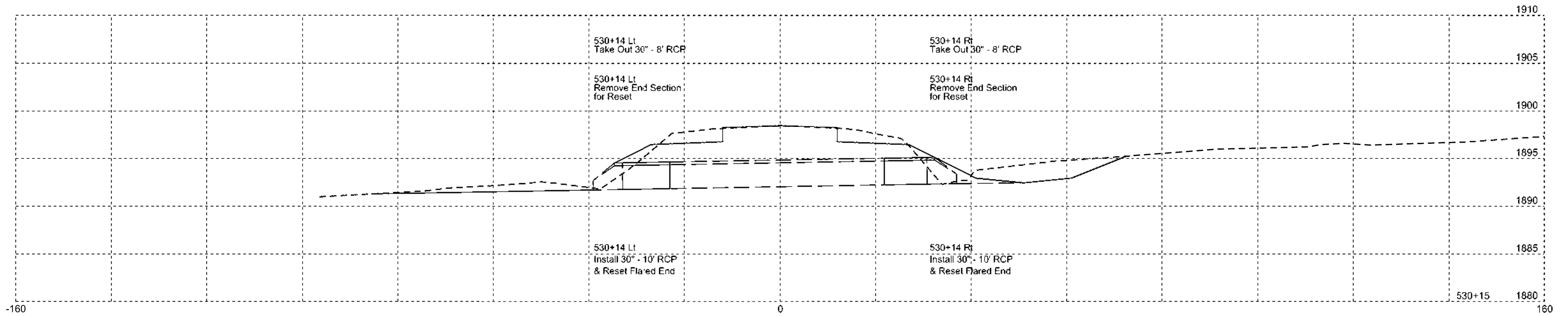

STATE OF SOUTH DAKOTA	PROJECT	SHEET	TOTAL SHEETS
	P 0047(117)67 P 0248(13)261	Z17	Z28

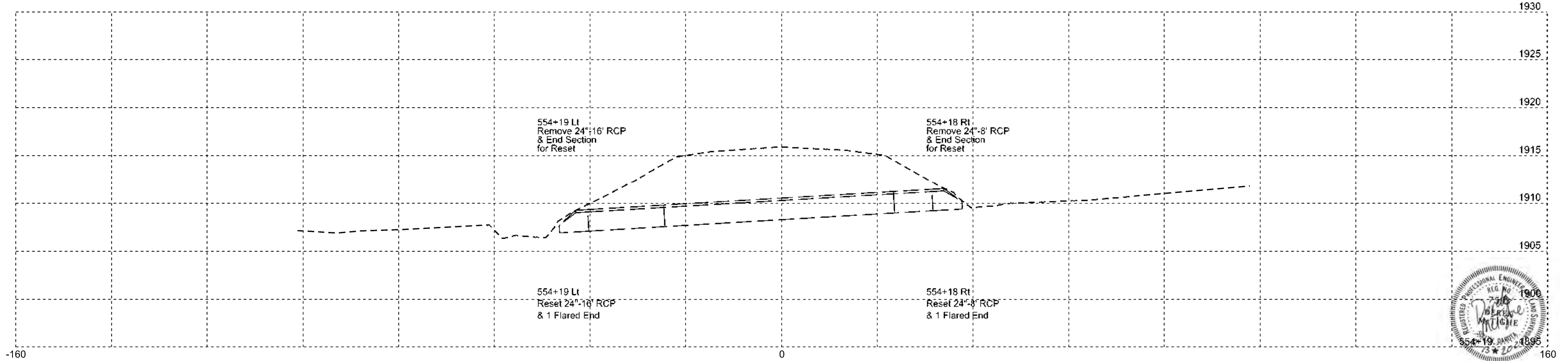
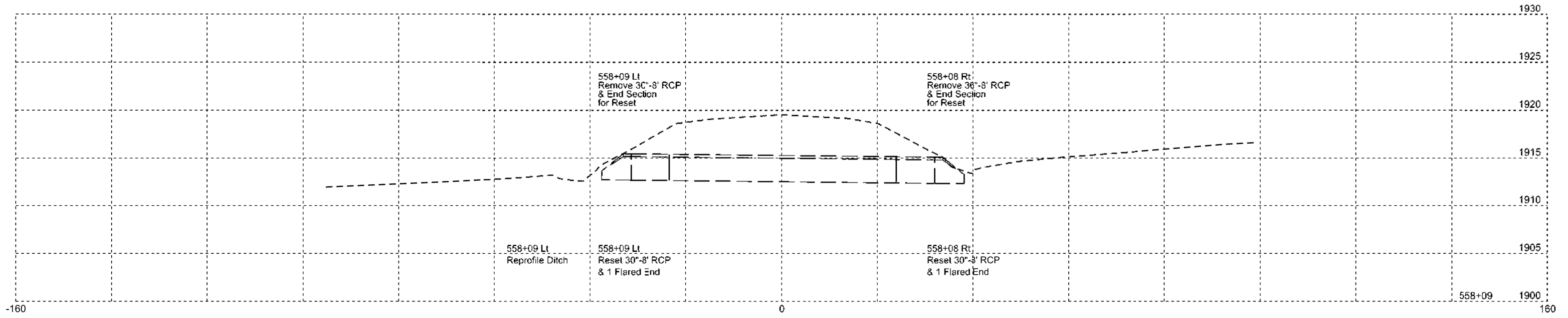

STATE OF SOUTH DAKOTA	PROJECT	SHEET	TOTAL SHEETS
	P 0047(117)67	Z18	Z28
	P 0248(13)261		

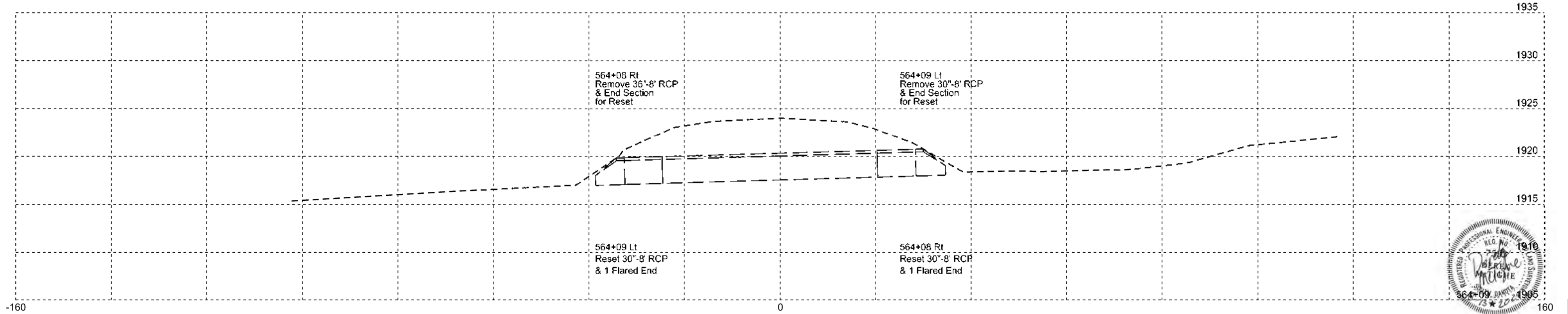
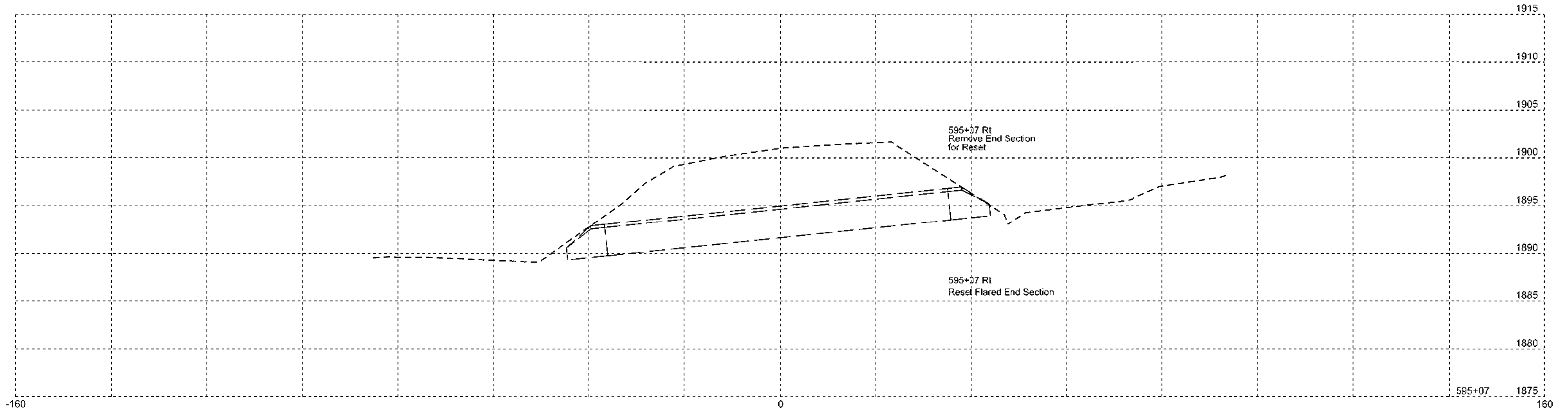

STATE OF SOUTH DAKOTA	PROJECT	SHEET	TOTAL SHEETS
	P 0047(117)67 P 0248(13)261	Z19	Z28

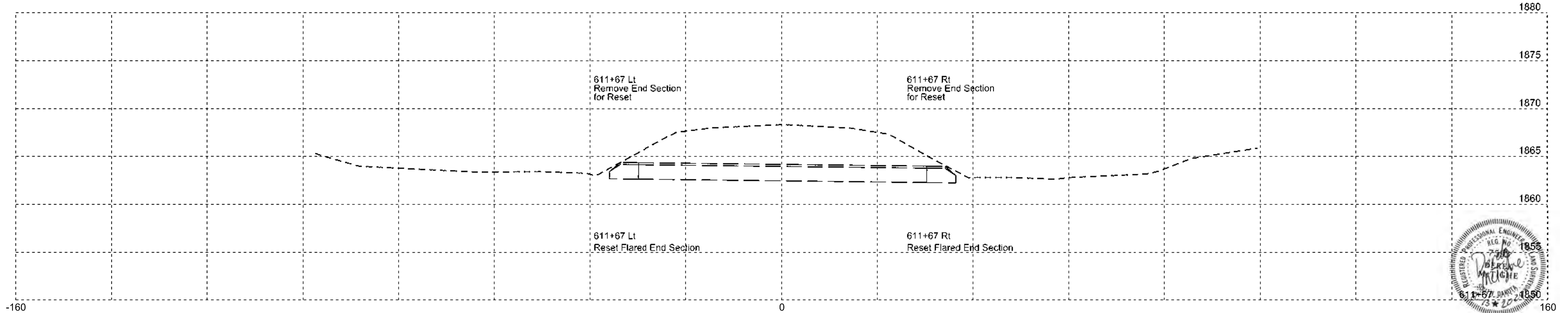
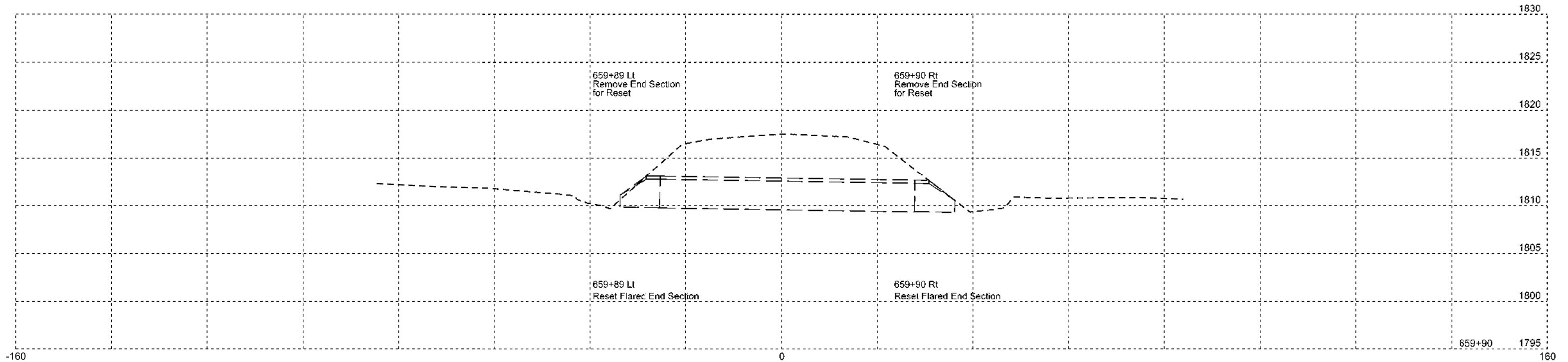

STATE OF SOUTH DAKOTA	PROJECT	SHEET	TOTAL SHEETS
	P 0047(117)67 P 0248(13)261	Z20	Z28

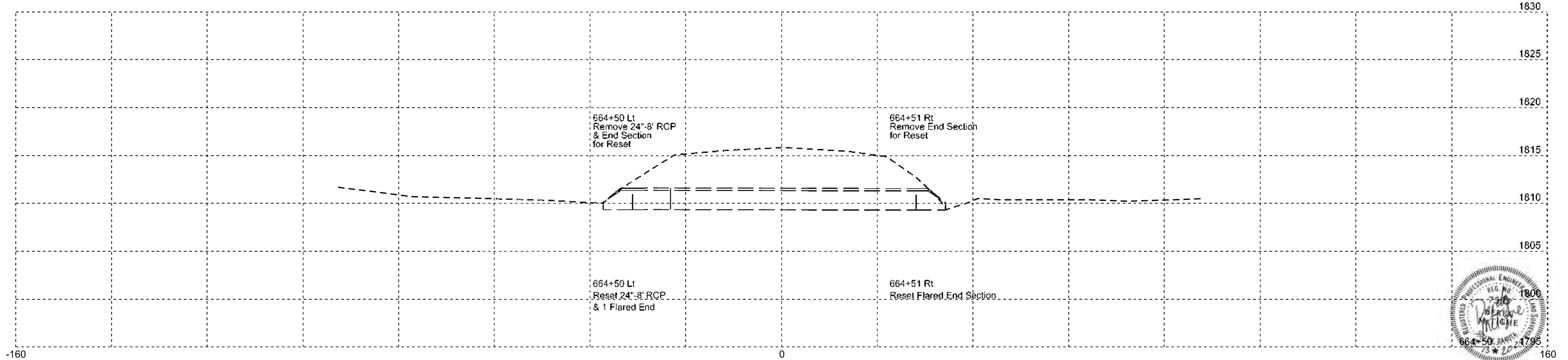
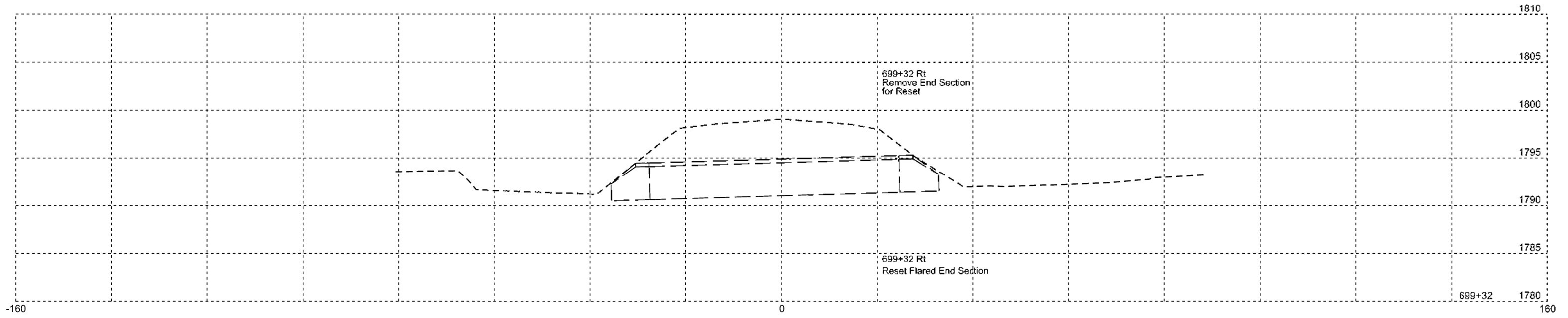

STATE OF SOUTH DAKOTA	PROJECT	SHEET	TOTAL SHEETS
	P 0047(117)67	Z21	Z28
	P 0248(13)261		

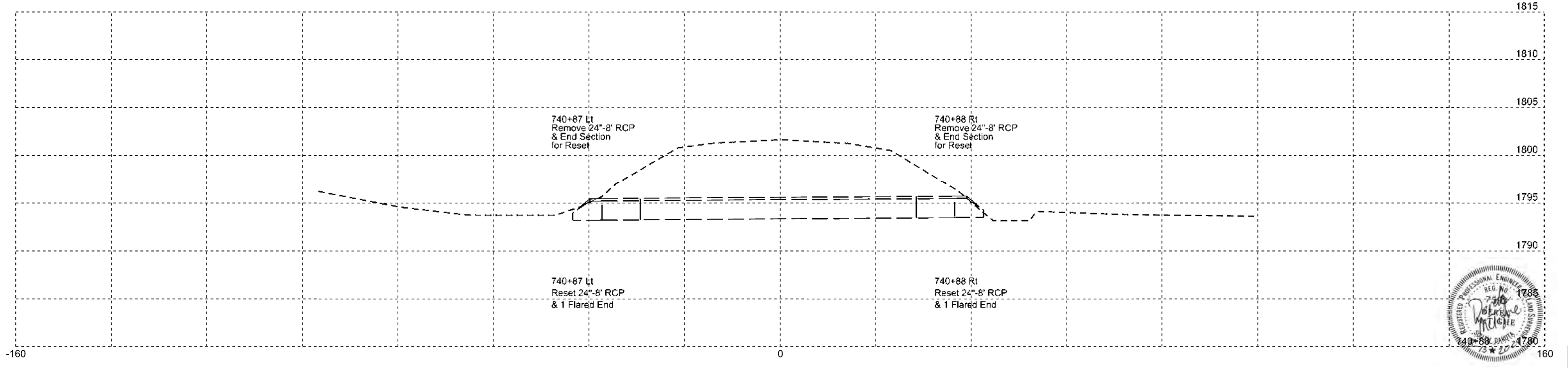
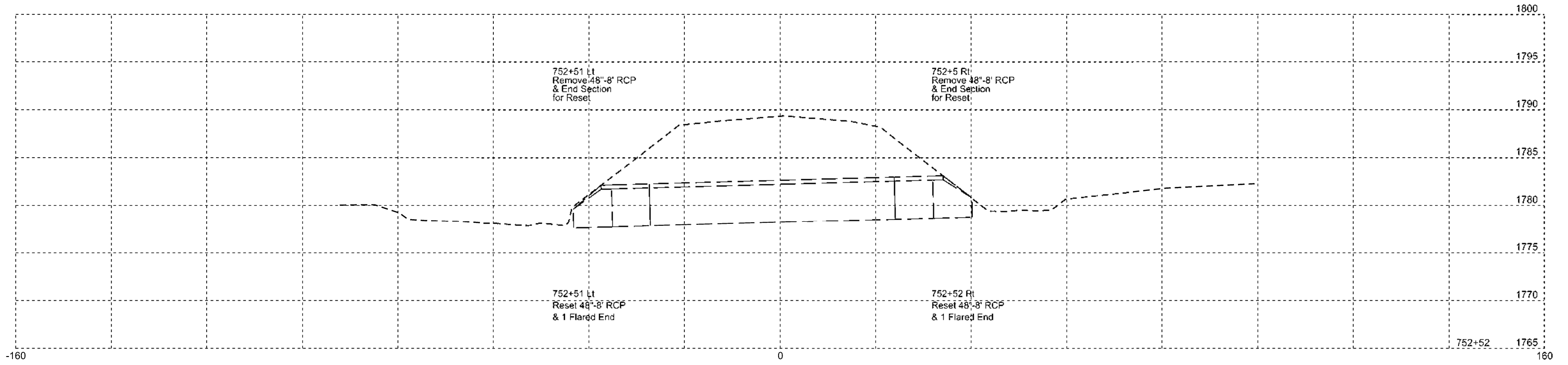

STATE OF SOUTH DAKOTA	PROJECT	SHEET	TOTAL SHEETS
	P 0047(117)67	Z22	Z28
	P 0248(13)261		

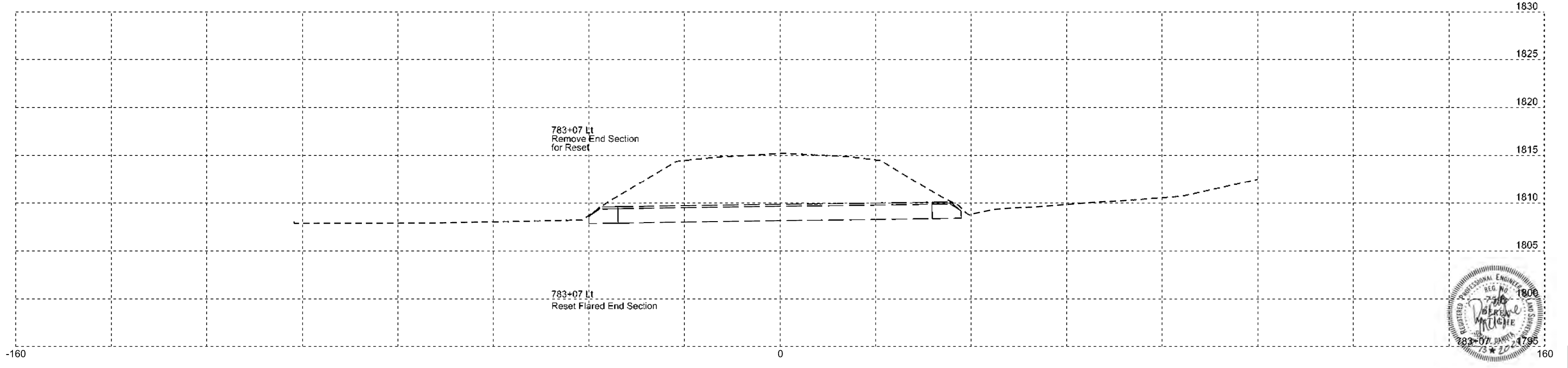
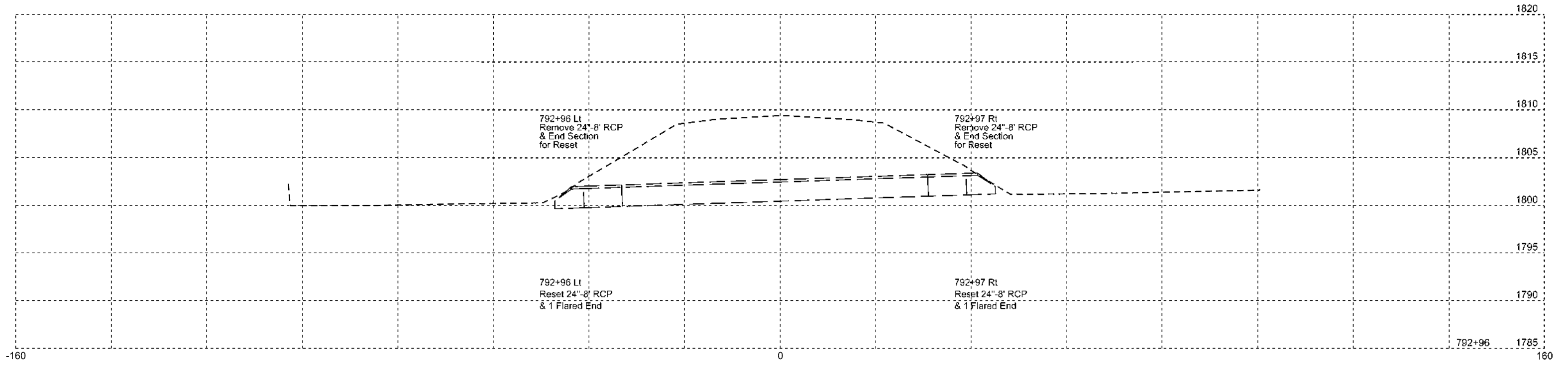

STATE OF SOUTH DAKOTA	PROJECT	SHEET	TOTAL SHEETS
	P 0047(117)67 P 0248(13)261	Z23	Z28

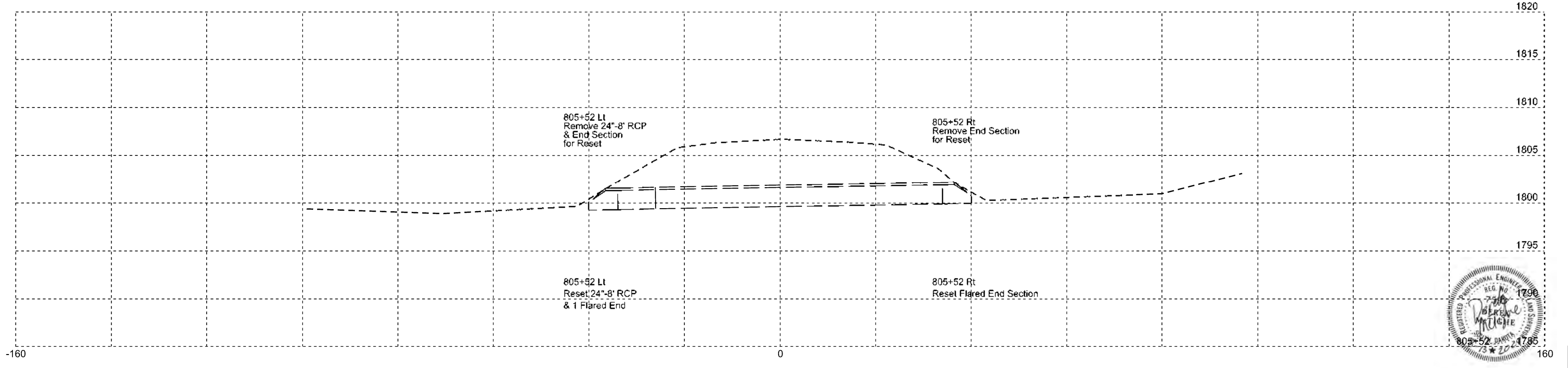
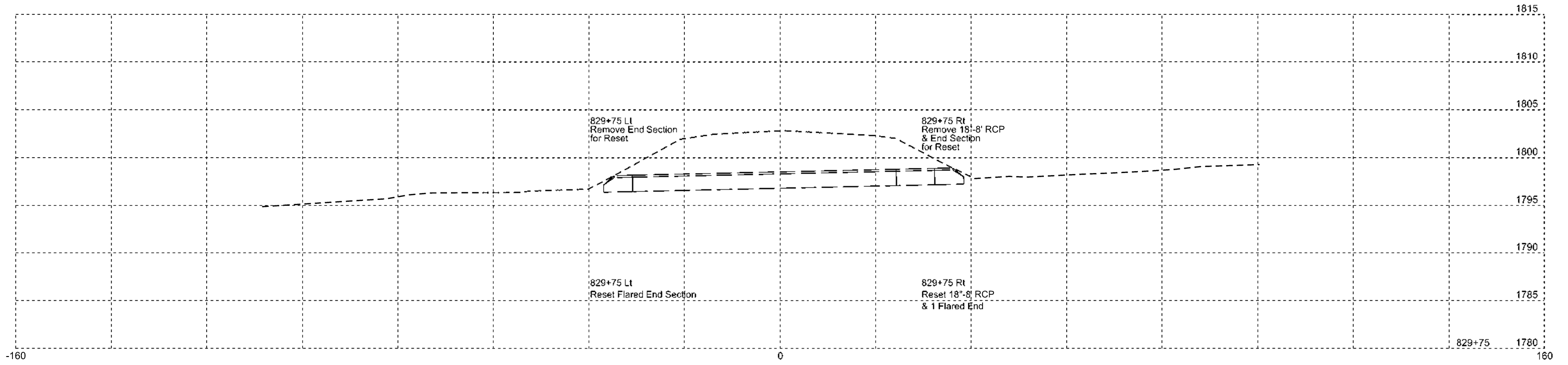

STATE OF SOUTH DAKOTA	PROJECT	SHEET	TOTAL SHEETS
	P 0047(117)67	Z24	Z28
	P 0248(13)261		

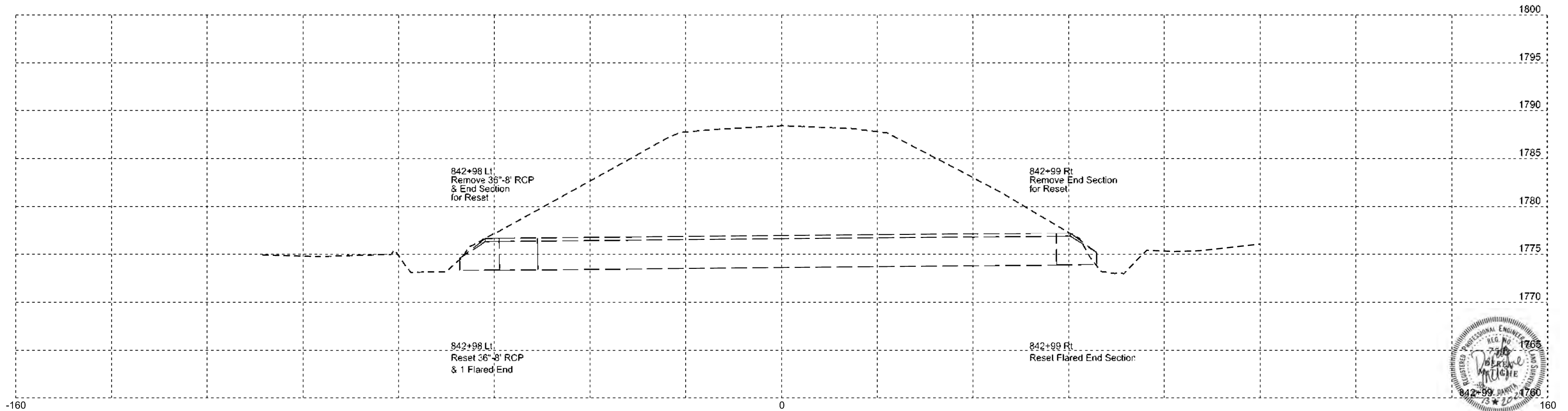
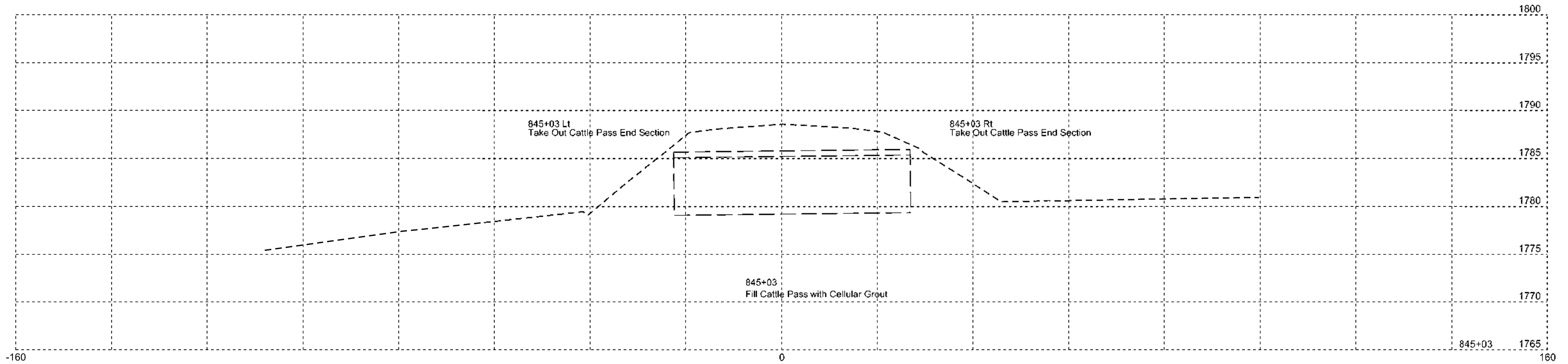

STATE OF SOUTH DAKOTA	PROJECT	SHEET	TOTAL SHEETS
	P 0047(117)67 P 0248(13)261	Z25	Z28

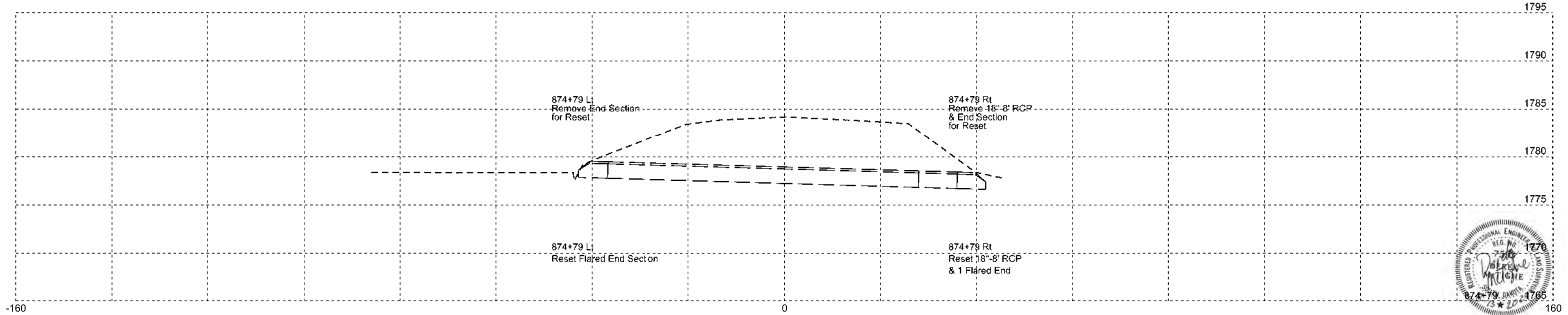
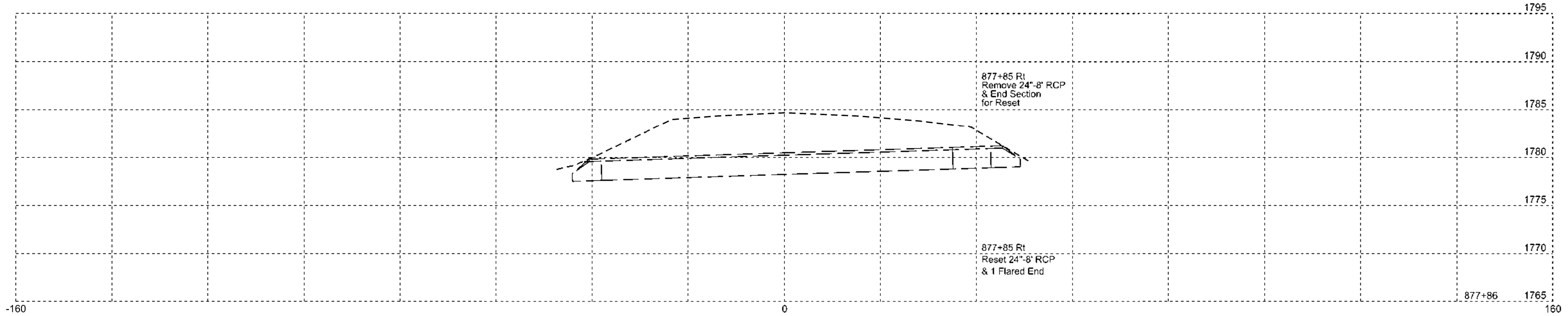
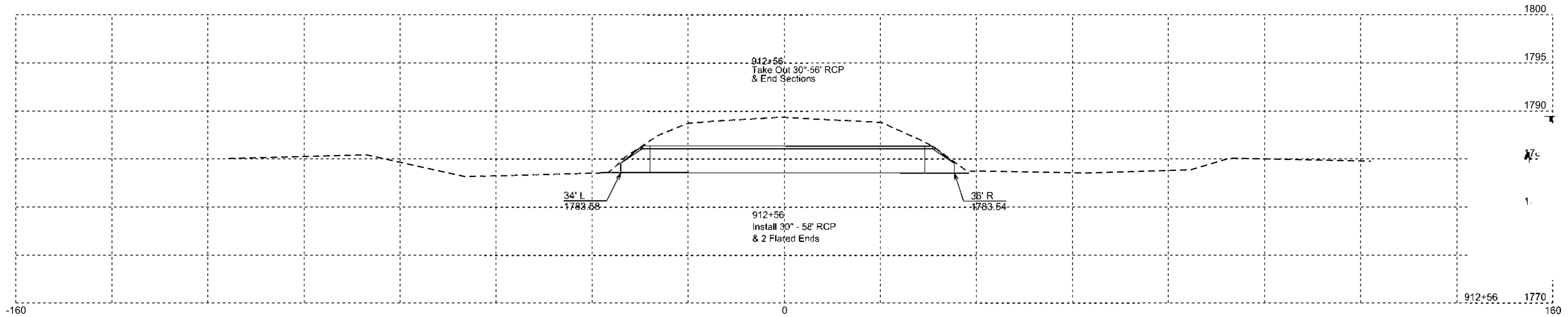

STATE OF SOUTH DAKOTA	PROJECT	SHEET	TOTAL SHEETS
	P 0047(117)67	Z26	Z28
	P 0248(13)261		

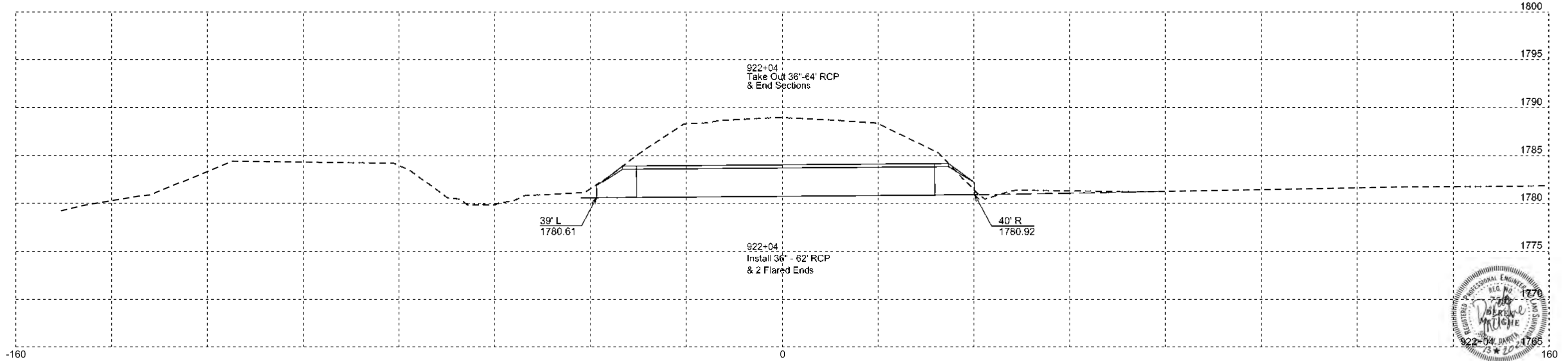
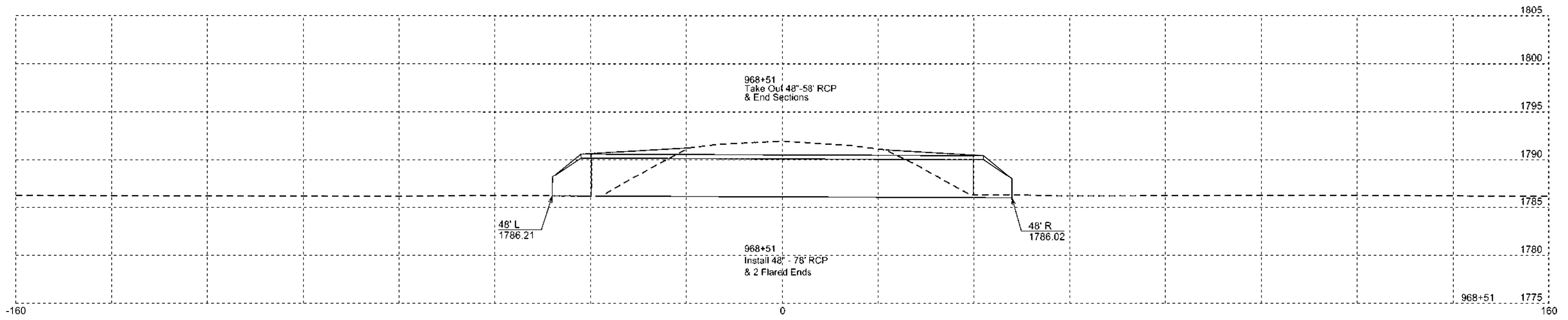

FOR BIDDING PURPOSES ONLY

STATE OF SOUTH DAKOTA	PROJECT	SHEET	TOTAL SHEETS
	P 0047(117)67 P 0248(13)261	Z27	Z28

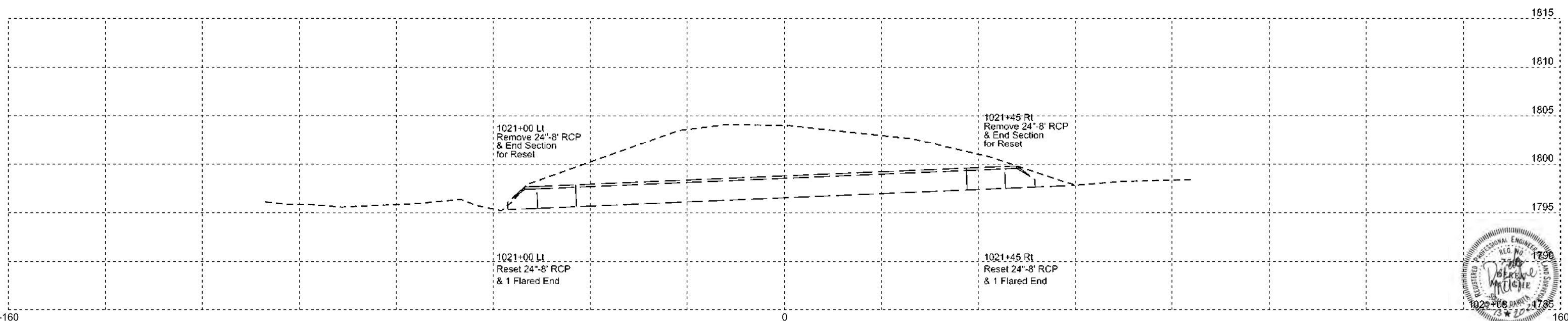

STATE OF SOUTH DAKOTA	PROJECT	SHEET	TOTAL SHEETS
	P 0047(117)67	Z28	Z28
	P 0248(13)261		

